



NARROW STILE

LEVER TRIM DESIGNS

Assorted outside trims provide security for all types of installations. Built to be as durable as the panic devices, these heavy-duty trims will stand up to heavy use and abuse. The versatile design of the trims, combined with the device mounting plate, makes changing functions as simple as replacing the outside trim. This can easily be done without removing the exit device from the door. Narrow stile trims can be used on 40 Series Rim, 50 / 51 Series Surface Vertical Rods and 60 / 61 / 62 / 63 Concealed Vertical Rods. Detex uses the BHMA functions/descriptions for all trims. Anti-Microbial Coating (AM) is available on all levers - contact factory for lead time and details.

DN / DNV / EU2W Trim

S Lever Standard



S Lever

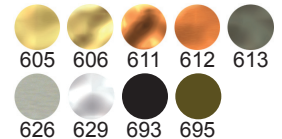
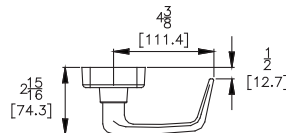

T Lever

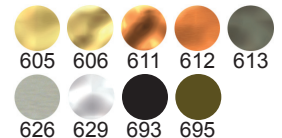
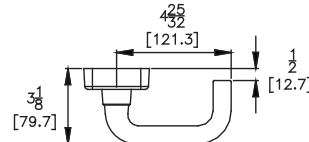

U Lever

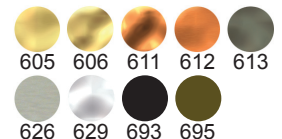
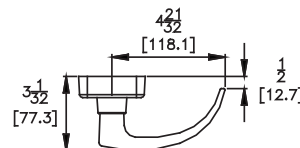

Q Lever

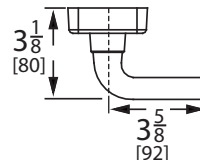

605 / US3	Polished Brass
606 / US4	Brushed Brass
611 / US9	Polished Bronze
612 / US10	Brushed Bronze
613 / US10B	Oil Rubbed Bronze
626 / US26D	Brushed Chrome
629 / US32	Polished Stainless Steel
693 / SPBLK	Black Painted
695 / SP313	Dark Bronze Painted



FSB Contemporary/European Designed Levers (630/US32D Brushed Stainless Steel Finish)

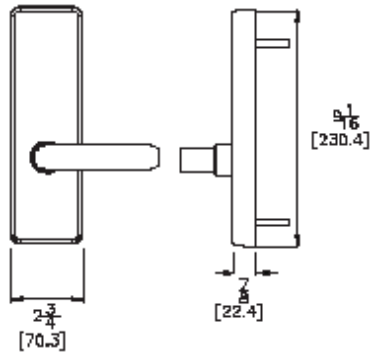

**FSB Lever
Trims available
in only 630/
US32D Brushed
Stainless Steel**



BHMA Function/Description

- 01 - Exit only, no trim or blank escutcheon
- 02 - Entrance by trim when actuating bar is locked down (dummy)
- 03 - Entrance by trim when latch bolt is released by key. Key removable only when locked.
- 08 - Entrance by knob or lever. Key locks or unlocks knob or lever.
- 09 - Entrance by knob or lever only when released by key. Key removable only when locked.
- 10 - Entrance by lever. Inside or outside key locks or unlocks lever.
- 14 - Entrance by trim when latch bolt is released by knob or lever. Always active, no cylinder.
- EU2W - Electric Lock / Unlock, wide escutcheon - Fail Secure or Fail Safe

Technical Information

- CN Trims are Stainless Steel
- DN and WS Trims are Forged Brass
- KN - Knurling available on all levers
- Advantex narrow stile trim also available for use with all Value Series Devices
- Narrow stile trim configured for use with BP2 or BP8 (when ordered with 03 function) - Standard for use on 40, 50/51 Series, BP10 or BP12 (when ordered with 03 function) - Standard for use on 60/61, 62/63 Series
Call factory for retrofit applications
- When ordered with device, trims will match mounting plate specified



Detex Corporation
302 Detex Drive
New Braunfels, Texas 78130-3045 USA
PH. (830) 629-2900
(800) 729-3839
FAX (830) 620-6711
(800) 653-3839
<http://www.detex.com>
USA Sales:
marketing@detex.com
International Sales:
export@detex.com