

*LIFE SAFETY,
SECURITY DOOR HARDWARE*

*INTEGRATED DOOR
SECURITY SYSTEMS*

*SAFETY, SECURITY
AND RISK MANAGEMENT*

PRICE LIST

Effective July 1, 2014

Where Trust is Built™
DETEX®
Life Safety and Security Door Hardware

NOTES

TABLE OF CONTENTS

Order Conditions	8
Warranties	9
Finishes Cross Reference Chart	9
Standards and Certifications	10

Life Safety and Security Door Hardware

ADVANTEK[®]

Wide Stile Devices

10 Series Rim Device (101379).....	13
20/21 Series Surface Vertical Rod Device (101559)	14
27 Series High Security Surface Vertical Rod Device	15
30 Series Mortise Lock Device (103200).....	16
Outside Trims for 10/20/21/30 Devices	17
FSB Levers and Trims	18

Narrow Stile Devices

40 Series Rim Device (101379).....	19
50/51 Series Surface Vertical Rod Device (101559)	20
Outside Trims for 40/50/51 Devices	21

Concealed Vertical Rod Devices

60/61/62/63 Series Concealed Vertical Rod Device (105260)	22
Outside Trims for 60/61/62/63 Devices	24
70/71 Series Concealed Vertical Rod Device (105280)	25
80/81/82/83 Series Concealed Vertical Rod Device (105280)	26
87 Series High Security Concealed Vertical Rod Device	28
Outside Trims for 70/71/80/81/82/83 Devices	29

00/01/04/05 Series No Latch Rail/Dummy Bars	30
---	----

Advantex How To Order	31
------------------------------------	----

Advantex Trim Cross Reference Matrix.....	32
---	----

Electrified Options	36
---------------------------	----

Advantex Easy Price Reference Chart	42
--	----

Parts & Accessories.....	46
--------------------------	----

Where Trust is Built™

DETEX[®]
Life Safety, Security and Security Assurance

TABLE OF CONTENTS CONTINUED

VALUE SERIES®

Standard & Narrow Stile Devices

Value Series V40 Rim Device (101800A)	50
Value Series V40xNS Narrow Stile Rim Device (101800A).....	51
Value Series V50/V51 Surface Vertical Rod Device (103550A)	52
Value Series V50xNS/V51xNS Narrow Stile Surface Vertical Rod Device (103550A)	53
Outside Trims for V40/V50/V51 Devices	54
Value Series Trim Cross Reference Matrix.....	55
Value Series How To Order	56
Electrified Options	57
Value Series Easy Price Reference Chart	62
Parts & Accessories	64

Series 800

Power Supplies and Logic Controllers (102881)	68
Power Supply Controllers	69
Power Supplies Accessories	71

Mullions

90 Series (100225)	72
--------------------------	----

AO19 SERIES®

(Low Energy Automatic Door Operators)

Automatic Operator - How to Order.....	74
Automatic Operator - AO19-1 (Single Door).....	75
Automatic Operator - AO19-2 (Pair of Doors).....	76
Automatic Operator - AO19-3 (Double Egress Doors)	77
Automatic Operator - AO19 Parts/Accessories	78

TABLE OF CONTENTS CONTINUED

ECL (Exit Control Locks)

Exit Control Locks (ECL-230D, ECL-600)	87
Accessories (ECL-230D, ECL-600).....	88
Keepers and Strike Kits	89
Multi-Point Security (ECL-230DxVRA)	90
Exit Control Locks (ECL-230X Single Point Lock)	91
Exit Control Locks (ECL-230X 2-Point Lock)	92
Exit Control Locks (ECL-230X 3-Point Lock)	93
Exit Control Locks Trim (ECL-230X)	94
Hinge Side Bolts (DX1, DX2, DX3)	94
Exit Control Locks Accessories (ECL-230X)	95
Cylinders and Accessories	96

EAX® (Exit Alarms)

Exit Alarms - EAX-500	98
Exit Alarms - EAX-2500	99
Exit Alarms - EAX-3500	100
Door Prop Alarms (EAX-300 Series and EAX-400 Series).....	101
Remote Alarms (CS-900 and CS-2900)	102
Door Switches	103
Accessories	104
Power Sources	105

Redi-Key

Key Vaults.....	106
-----------------	-----

DTX® (Access Control)

DTX-2000 Series	108
DTX-4000 Series How to Order.....	109
DTX-4000 Series	109
Options and Accessories	112
Anti-tailgate Pedestals.....	113

TABLE OF CONTENTS CONTINUED

Miscellaneous

Keyswitches and Covers (103455)	114
Motion Sensor	114
Push Buttons	115
Electric Strikes	115
Electromagnetic Locks	116
Weatherized Horns/Strobes	116
Power Transfers/Electric Hinges	116
Remote Indicating Panels.....	117
NEMA Enclosures.....	117

Integrated Door Security Systems

EasyKit[®]

Access Control Doors.....	118
Delayed Egress Doors.....	122
Weatherized Delayed Egress Doors	123
Electrified Dogging	124
Electrified Dogging For Campus Lockdown	125
Automatically Operated Doors.....	126

Safety, Security and Risk Management

Order Conditions	130
ProxiPen / TopGuard Patrol	131
RELIANT[™] PLUS	132
Guardzman	133
Newman / Newman Quartz	133
Safe-T-Chek	134

NOTES

ORDER CONDITIONS

Prices: Prices are subject to change without notice. **No prices are guaranteed;** all shipments will be made at prices prevailing at the time of receipt of order.

Terms: Net 45 days. Past due accounts may be subject to a shipping hold.

Acceptance: We reserve the right to decline an order, in whole or part, when the type or quantity of goods or credit worthiness of the purchaser is not satisfactory.

Delivery: All shipments are Ex Works Factory New Braunfels, Texas. **Freight allowance (ground service only) will be based on individual shipments of \$7,000 or more in the contiguous U.S. and Canada.** Most standard products in standard finish are typically built and shipped from Detex within 5 working days from receipt of order. Detex has consistently met the 5 day fill rate standard 99% of the time for the past 5 years. **To continue to provide this level of on time production and maintain this fill rate, Detex must charge a 20% special handling fee for any order requiring shipping in less than 5 days.** Orders will ship prior to the 5th working day or you will not pay the 20% special handling fee. All orders are subject to factory acceptance and no guarantee is made that the order will ship prior to the 5th day.

Returned Goods: Materials may be returned for credit within **six (6) months** of purchase. No goods will be accepted for return unless a **Return Materials Authorization** has been issued. Contact your local representative with requests. **Returns must be unmounted and in original packaging.** Credit will be issued at price paid or current price, whichever is lower, less a minimum 25% restocking charge. **Obsolete, discontinued or special products are not returnable.**

Special Order Items: Detex Custom Engineered EasyKits, products made for a specific customer requirement and other specialized one of a kind products are **non-returnable** and **non-cancelable**, and may require a prepayment of 50%. Exit devices can be precut at factory - call for pricing.

Cancellation & Changes: If orders have been entered for manufacturing, cancellations cannot be accepted without our permission and may be subject to a cancellation charge.

Corrections: We expressly reserve the right to correct clerical, stenographic and other obvious errors at any time.

TOLL FREE FAX NUMBER FOR PLACING ORDERS

1-800-653-3839

**TOLL FREE NUMBER FOR PLACING ORDERS DIRECTLY TO
OUR SALES DEPARTMENT**

1-800-729-3839

or e-mail

sales@detex.com

International e-mail

export@detex.com

For the name of the representative in your area,
see our web page at www.detex.com or call factory.

WARRANTIES

Limited Warranties:

Detex® **ADVANTEX**® and **Value Series**® panic hardware, when properly installed, used and maintained, is warranted to be free of defects in material and workmanship. We will, for a period of ten (10) years from the date of purchase, **repair or replace** any part which, upon our examination, proves to be defective under normal use. Electrical components, when properly installed and maintained, are warranted to be free of defects in material and workmanship for a period of three (3) years. This warranty will be honored only upon presentation of proof that the product covered thereby was purchased directly from an authorized Detex distributor. WE SHALL NOT BE LIABLE FOR ANY DIRECT, INCIDENTAL OR CONSEQUENTIAL LOSS OR DAMAGE ARISING OUT OF THE FAILURE OF THIS PANIC HARDWARE TO OPERATE.

Warranty Conditions: Detex power supplies are required when powering Delayed Egress and Latch Retraction exit devices. Failure to use Detex recommended power supplies will void manufacturers warranty.

Limited Warranty:

All Detex security hardware products or signaling devices are warranted to be free of defects in material and workmanship when properly installed, used and maintained according to instructions. We will, for a period of *three (3) years from the date of purchase, **repair or replace** any part which, upon our examination, proves to be defective under normal use. (This does not apply to batteries or to damage from battery leakage.) This warranty will be honored only upon presentation of proof that the product covered thereby was purchased directly from an authorized Detex Distributor. WE SHALL NOT BE LIABLE FOR ANY DIRECT, INCIDENTAL OR CONSEQUENTIAL LOSS OR DAMAGE ARISING OUT OF THE FAILURE OF THE PRODUCT OR DEVICE.

*ECL-230D, ECL-230D-PH, ECL-230X, ECL-600 and 90KR — ten (10) years
AO19 Series — 3 year mechanical / 1 year electrical

FINISHES CROSS REFERENCE CHART

BHMA	US		BHMA	US	
605	US3	Brass, bright - PVD	626	US26D	Chromium, satin
606	US4	Brass, satin - PVD	628	US28	Aluminum, satin
611	US9	Bronze, bright - PVD	629	US32	Stainless Steel, bright
612	US10	Bronze, satin - PVD	630	US32D	Stainless Steel, satin
613	US10B	Bronze, oil rubbed - PVD	689	SP28	Lacquer Sprayed Aluminum
619	US15	Satin, Nickel Plated, Clear-coated	693	SPBLK	Black, painted
622	US19	Flat Black, painted	695	SP313	Dark Bronze, painted
625	US26	Chromium, bright	711	DC35	Anodized Aluminum, black

Note: See product details for finishes offered
PVD = Physical Vapor Deposition





STANDARDS AND CERTIFICATIONS

Product	Type	Application	3 Hour Fire Rated Openings	UL LISTED		Wind Storm Listing	Mortise Cylinder Required	Limited Warranty
Advantex								
10 Series	Relatching Lock	Rim Exit	Yes*	Yes	4140-0127:0105 3774-0127:0106 3725-0127:0108	Yes**	CD, EA, EI, EE, EExER & EM	10/3 years
20 Series	Relatching 2 point Lock	SVR	Yes*	Yes	4140-0127:0105 3774-0127:0106 3725-0127:0108	No NOA	CD, EA, EE, & EExER	10/3 years
21 Series	Relatching Lock	SVR Top Rod Only	Yes*	Yes	4140-0127:0105 3774-0127:0106 3725-0127:0108	No NOA	CD, EA, EE, & EExER	10/3 years
27 Series	Heavy Duty 2 point Relatching Lock	SVR	Contact Factory	Yes	Contact Factory	FEMA 361	CD, EA, EE, & EExER	10/3 years
30 Series	Mortise Lock	Mortise Exit Device	Yes*	Yes	4140-0127:0105 3774-0127:0106 3725-0127:0108	No NOA	CD, EA, EE, & EExER	10/3 years
40 Series	Relatching Lock	Narrow Stile Rim Exit Device	Yes*	Yes	4140-0127:0105 3774-0127:0106 3725-0127:0108	Yes**	CD, EA, EI, EE, EExER & EM	10/3 years
50 Series	Relatching 2 point Lock	Narrow Stile SVR	Yes*	Yes	4140-0127:0105 3774-0127:0106 3725-0127:0108	No NOA	CD, EA, EE, & EExER	10/3 years
51 Series	Relatching Lock	Narrow Stile SVR Top Rod Only	Yes*	Yes	4140-0127:0105 3774-0127:0106 3725-0127:0108	No NOA	CD, EA, EE, & EExER	10/3 years
60 Series	Relatching 2 point Lock	CVR for Aluminum Doors	Yes* With Steel Door	Yes	4140-0127:0110 3774-0127:0106 3725-0127:0108	No NOA	CD, EA, EE, & EExER	10/3 years
61 Series	Relatching Lock	CVR for Aluminum Doors Top Rod Only	Yes* With Steel Door	Yes	4140-0127:0110 3774-0127:0106 3725-0127:0108	No NOA	CD, EA, EE, & EExER	10/3 years
70 Series	Relatching 2 point Lock	CVR for Wood Doors	Yes* Contact Factory	Yes	4140-0127:0110 3774-0127:0106 3725-0127:0108	No NOA	CD, EA, EE, & EExER	10/3 years
71 Series	Relatching Lock	CVR for Wood Doors Top Rod Only	Yes Contact Factory	Yes	4140-0127:0110 3774-0127:0106 3725-0127:0108	No NOA	CD, EA, EE, & EExER	10/3 years
80 Series	Relatching 2 point Lock	CVR for Hollow Metal Doors	Yes*	Yes	4140-0127:0110 3774-0127:0106 3725-0127:0108	No NOA	CD, EA, EE, & EExER	10/3 years
81 Series	Relatching Lock	CVR for Hollow Metal Doors Top Rod Only	Yes*	Yes	4140-0127:0110 3774-0127:0106 3725-0127:0108	No NOA	CD, EA, EE, & EExER	10/3 years
82 Series	Relatching 2 point Lock	CVR for Aluminum Doors	Yes*	Yes	4140-0127:0110 3774-0127:0106 3725-0127:0108	No NOA	CD, EA, EE, & EExER	10/3 years
83 Series	Relatching Lock	CVR for Aluminum Doors Top Rod Only	Yes*	Yes	4140-0127:0110 3774-0127:0106 3725-0127:0108	No NOA	CD, EA, EE, & EExER	10/3 years
87 Series	Heavy Duty 2 point Relatching Lock	CVR	Contact Factory	Yes	Contact Factory	FEMA 361	CD, EA, EE, & EExER	10/3 years
Value Series								
V40 Series	Relatching Lock	Rim Exit Device	Yes*	Yes	4140-0127:0105 3774-0127:0106 3725-0127:0108	Yes**	CD, EB(W), EE, EH(R), EI, & EM	10/3 years
V50 Series	Relatching 2 point Lock	SVR	Yes*	Yes	4140-0127:0105 3774-0127:0106 3725-0127:0108	No NOA	CD, EB, EE, EH(R), EBxW	10/3 years
V51 Series	Relatching Lock	SVR Top Rod Only	Yes*	Yes	4140-0127:0105 3774-0127:0106 3725-0127:0108	No NOA	CD, EB, EE, EH(R), EBxW	10/3 years

* Add Prefix "F" for 3 hour Fire Exit Hardware

**Add Prefix "H" for Miami-Dade Hurricane Component Approval listing
see www.miamidade.gov - NOA #13-0717.13 & Florida Building Code www.floridabuilding.org - approval #FL9052
10/3 year warranty = 10 year limited warranty on mechanical components,
3 year limited warranty on electrical components

STANDARDS AND CERTIFICATIONS

Product	Type	Application	3 Hour Fire Rated Openings			Wind Storm Listing	Mortise Cylinder Required	Limited Warranty
AO19 Series	Low Energy Automatic Operator	Single, Pairs, and Double Egress Doors	Yes*		N/A	N/A	N/A	3/1 years
90KR	Keyed Removable Mullion	Pairs of Doors	Yes*	Yes	N/A	No NOA	Rim	10 years
H90R	Removable Mullions	Pairs of Doors	Contact Factory	Yes	N/A	Yes**	N/A	10 years
ECL-230D	Deadbolt Lock	9V Alarm	No	Yes	4140-0127:0102	No NOA	Rim	10 years
ECL-230D-PH	Deadbolt Lock	9V Alarm	No	Yes	4140-0127:0102	No NOA	Rim	10 years
ECL-230X	Deadbolt Lock	9V Alarm	No	Yes	4140-0127:0109	Yes** 18ga dr +70/-65 PSF	Rim	10 years
ECL-230X-TD	2-Point Deadbolt Lock	9V Alarm	No	Yes	4140-0127:0109	No NOA	Rim	10 years
ECL-230X-TB	SVR Non-Relatching Lock	9V Alarm	No	Yes	4140-0127:0109	No NOA	Rim	10 years
ECL-230X-TDB	3-Point Deadbolt Lock	9V Alarm	No	Yes	4140-0127:0109	Yes** 18ga dr +70/-65 PSF 16ga dr +80/-80 PSF	Rim	10 years
ECL-600	Deadbolt & Relatching 2-Point Lock	9V Alarm	Yes		4140-0127:0102	No NOA	Rim	10 years
VRA-143	2-Point Vertical Rod Deadbolt Lock	N/A	No	Yes	N/A	No NOA	N/A	3 years
EAX-300	Door Prop Alarm	9V Alarm	Yes***	ANSI 156.29 Listed	N/A	-†	Mortise	3 years
EAX-500	Door Mount Alarm	9V Alarm	Yes***	ANSI 156.29 Listed	N/A	-†	Mortise	3 years
EAX-2500	Wall Mount Door Alarm	12-24VAC Alarm	-†	ANSI 156.29 Listed	N/A	-†	Mortise	3 years
EAX-3500	Timed Bypass Exit Alarm	24VAC / VDC Alarm	-†	N/A	N/A	N/A	Mortise	3 years
BE-961	Power Supply	9VDC Power Supply	-†	N/A	N/A	-†	N/A	3 years
Series 800	Power Supplies & Logic Controllers	Power Supplies w/ Logic	-†	Yes	3774-0127:0107	-†	N/A	3 years
MS-2049	Magnetic Door Switch	Industrial grade	Yes***	Yes	N/A	N/A	N/A	3 years
MS-1039/59	Magnetic Switch	Standard grade	No	N/A	N/A	N/A	N/A	3 years
DTX Series	Access Keypad / Card Readers	Access Control	-†	N/A	N/A	-†	N/A	3 years

* Add Prefix "F" for 3 hour Fire Exit Hardware

**Add Prefix "H" for Miami-Dade Hurricane component. Approval listing see www.miamidade.gov reference NOA 13-0617.22.

*** UL Listed Miscellaneous Fire Door Accessory

10/3 year warranty = 10 year limited warranty on mechanical components, 3 year limited warranty on electrical components

-† Wall mounted - may be used with Rated Openings

NOTES

ADVANTEX® 10 SERIES RIM EXIT DEVICE



08 D with S Lever (Standard) - shown



(1010D shown)
NOTE:
For all trim information and graphics see page 17



(EC2 Endcap)

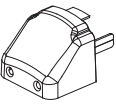

(EC1 Endcap)



(99 Strike)



(94 Strike)



(98 Strike)

MC65



IC7



RC65



IC7R



Finishes

Outside Function	Device	630 (Std.)	628	693, 695	606, 612, 613	605, 611, 629
Device Only - Exit Only No Trim	10	\$1,082.00	\$990.00	\$1,040.00	\$1,203.00	\$1,427.00
	Device/ Function/Trim	630/630	628/630			
01 Exit only, cover plate	1001C	\$1,224.00	\$1,130.00	\$1,194.00	\$1,362.00	\$1,589.00
	1001W	\$1,242.00	\$1,150.00	*	\$1,383.00	\$1,610.00
02 Dummy pull trim	1002C	\$1,301.00	\$1,209.00	\$1,278.00	\$1,449.00	\$1,678.00
	1002Z	\$1,658.00	\$1,566.00	*	*	*
03 Key Retracts Latch pull trim	1003C	\$1,330.00	\$1,238.00	\$1,309.00	\$1,481.00	\$1,710.00
	1003Z	\$1,581.00	\$1,489.00	*	*	*
03 Key Retracts Latch cylinder trim	1003W	\$1,242.00	\$1,150.00	*	\$1,383.00	\$1,610.00
	1003WS	\$1,227.00	\$1,135.00	*	\$1,391.00	\$1,619.00
		630/626	628/626	*Contact Factory for Availability		
01 Blank Escutcheon	1001D	\$1,494.00	\$1,402.00	\$1,489.00	\$1,665.00	\$1,899.00
02 Dummy Lever Trim	1002D	\$1,494.00	\$1,402.00	\$1,489.00	\$1,665.00	\$1,899.00
08 Key Locks/Unlocks Outside Lever	1008D	\$1,534.00	\$1,442.00	\$1,532.00	\$1,745.00	\$1,980.00
09 Lever Trim Active by Key; Locked when key removed	1009D	\$1,534.00	\$1,442.00	\$1,532.00	\$1,745.00	\$1,980.00
10 Double Cylinder	1010D	\$1,741.00	\$1,649.00	\$1,769.00	\$1,954.00	\$2,193.00
14 Outside Lever Always Active	1014D	\$1,534.00	\$1,442.00	\$1,532.00	\$1,745.00	\$1,980.00
EU Electric Lock/Unlock	10EU	\$2,020.00	\$1,928.00	\$2,062.00	\$2,240.00	\$2,464.00

Kaba Mechanical & Electronic Pushbutton Access Control Lever Trim - See EasyKit/Access Control Doors/ACD Section

DEVICE COMES STANDARD WITH:

- Same finish, device exterior (except 628 finish which includes stainless steel cover, pushpad and endcap)
- HD Hex Dogging
- 36" 36" Device for 3 foot doors
- EC1 Ramped Endcap - Heavy Duty (standard on 630, 606, 612, 613, 605, 611 & 629 finishes only)
- 99 Surface Strike
- EC2 Flush Endcap (standard on 628, 693 & 695 finishes only)

OPTIONS

- F Fire Rated - Specify prefix F (ex. F1001) Add \$125.00
- H Hurricane Rated - Specify prefix H (ex. H1001) Add \$75.00
- FH Fire Rated/Hurricane Rated - Specify prefix FH (ex. FH1001) Add \$200.00
- W Weatherized (Mechanical only - For weatherized electrified functions, see Electrified Options) Add \$79.00
- Electrified Options - see pages 36-41**
- Custom lengths - Specify size (min. 24" to max. 48") Add \$75.00
 - Note: See Electrified Options for availability on devices shorter than 30", certain sizes require EC2 endcap
- 48" 48" Device for 4' 0" doors Add \$31.00
- AM Anti-Microbial (Pushpad, pull handles, and lever handles only) Add \$60.00
- KS Key Stop Installed Add \$5.00
- SLR Silent Pushpad Return Add \$75.00
- CD Cylinder Dogging N/C*
- LD Less Dogging N/C*
- 94 Double Door Strike available - see page 46
- 98 Semi-Mortise Strike N/C*

NOTE - Cylinders not included. Products on this page can be ordered with cylinders (C65) or Interchangeable core housings (IC7) pre-installed at Detex prior to shipping (See page 47).

N/C* - No charge when ordered with device

Where Trust is Built™



20/21 SERIES SURFACE VERTICAL ROD EXIT DEVICES

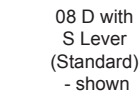
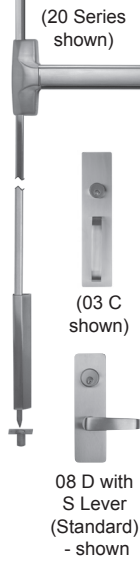
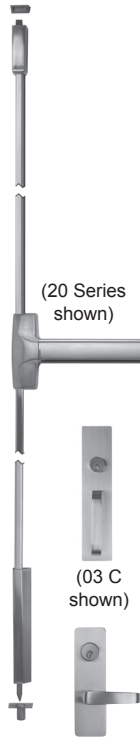

NOTE:
For all trim information and graphics see page 17

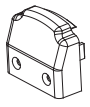

(EC2 Endcap)

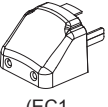

(EC1 Endcap)



(97 Surface Strike)

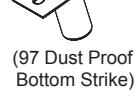

(97 Dust Proof Bottom Strike)

Outside Function	Top & Bottom Rod Device		Top Rod Only Device		Finishes				
	20	21	630 (Std.)	628	693, 695	606, 612, 613	605, 611, 629		
Device Only - Exit Only No Trim	20	21	\$1,733.00	\$1,529.00	\$1,621.00	\$1,842.00	\$2,045.00		
	Device/Function/Trim		630/630	628/630	* Contact Factory for Availability				
01 Exit only, cover plate	2001C	2101C	\$1,875.00	\$1,671.00	\$1,775.00	\$2,001.00	\$2,207.00		
	2001W	2001W	\$1,893.00	\$1,689.00	*	\$2,018.00	\$2,221.00		
02 Dummy pull trim	2002C	2102C	\$1,952.00	\$1,748.00	\$1,860.00	\$2,088.00	\$2,296.00		
	2002Z	2102Z	\$2,309.00	\$2,105.00	*	*	*		
03 Key Retracts Latch pull trim	2003C	2103C	\$1,981.00	\$1,777.00	\$1,891.00	\$2,120.00	\$2,328.00		
	2003Z	2103Z	\$2,232.00	\$2,028.00	*	*	*		
03 Key Retracts Latch cylinder trim	2003W	2103W	\$1,893.00	\$1,689.00	*	\$2,022.00	\$2,228.00		
	2003WS	2103WS	\$1,878.00	\$1,674.00	*	\$2,030.00	\$2,237.00		
01 Blank Escutcheon	2001D	2101D	\$2,145.00	\$1,941.00	\$2,070.00	\$2,304.00	\$2,517.00		
02 Dummy Lever Trim	2002D	2102D	\$2,145.00	\$1,941.00	\$2,070.00	\$2,304.00	\$2,517.00		
08 Key Locks/Unlocks Outside Lever	2008D	2108D	\$2,185.00	\$1,981.00	\$2,113.00	\$2,384.00	\$2,598.00		
09 Lever Trim Active by Key; Locked when key removed	2009D	2109D	\$2,185.00	\$1,981.00	\$2,113.00	\$2,384.00	\$2,598.00		
14 Outside Lever Always Active	2014D	2114D	\$2,185.00	\$1,981.00	\$2,113.00	\$2,384.00	\$2,598.00		
EU Electric Lock/Unlock	20EU	21EU	\$2,671.00	\$2,467.00	\$2,643.00	\$2,879.00	\$3,082.00		

Note: Devices are shipped RHR unless specified LHR (Field Reversible)

DEVICE COMES STANDARD WITH:

- Rod, Latch and ADA Bottom Bolt Covers
- Same finish, device exterior (except 628 finish which includes stainless steel cover, pushpad and endcap)
- EC1 Ramped Endcap - Heavy Duty (standard on 630, 606, 612, 613, 605, 611 & 629 finishes only)
- EC2 Flush Endcap (standard on 628, 693 & 695 finishes only)
- HD Hex Dogging
- 36" 36" Device for 3 foot doors
- 84" 84" Rods for 7 foot doors
- 97 Surface Strike
- 97 Dust Proof Bottom Strike (20 Series only)

OPTIONS

(N/C* - No charge when ordered with device)

- F Fire Rated - Specify prefix F (ex. F2001) - Fire pin included for 21 Series Only Add \$125.00
- W Weatherized (Mechanical only - For weatherized electrified functions, see Electrified Options) Add \$79.00
- For Electrified Options see pages 36-41**
- Custom lengths - Specify size (min. 24" to max. 48") Add \$75.00
 - Note: See Electrified Options for availability on devices shorter than 30", certain sizes require EC2 endcap
 - 48" 48" Device for 4'0" doors Add \$31.00
 - 96" Add for 8' doors Add \$20.00
 - 120" Add for 10' doors Add \$50.00
 - AM Anti-Microbial (Pushpad, pull handles, and lever handles only) Add \$60.00
 - KS Key Stop Installed Add \$5.00
 - SLR Silent Pushpad Return Add \$75.00
 - CD Cylinder Dogging N/C*
 - LD Less Dogging N/C*

NOTE - Cylinders not included. Products on this page can be ordered with cylinders (C65) or Interchangeable core housings (IC7) pre-installed at Detex prior to shipping (See page 47).

NOTE - Application note for 2' device (Available on Surface Vertical Device. Will ship less UL Fire label):
When vertical rod devices are used on both doors of a pair, operation of the inactive door (smaller door) will not disengage the active door, creating a potential safety issue for those using the inactive door during an emergency.





27 SERIES HIGH SECURITY SURFACE VERTICAL ROD EXIT DEVICES

27 SERIES ROD COVERS SOLD SEPARATELY

Outside Function	Top & Bottom Rod Device	Finishes				
		630 (Std.)	628	693, 695	606, 612, 613	605, 611, 629
Device Only - Exit Only No Trim	27	\$2,498.00	N/A	\$2,348.00	\$2,655.00	\$2,948.00
	Device/Function/Trim	630/630	628/630	* Contact Factory for Availability		
01 Exit only, cover plate	2701C	\$2,640.00	N/A	\$2,503.00	\$2,814.00	\$3,110.00
	2701W	\$2,658.00	N/A	*	\$2,831.00	\$3,124.00
02 Dummy pull trim	2702C	\$2,717.00	N/A	\$2,587.00	\$2,901.00	\$3,199.00
	2702Z	\$3,074.00	N/A	*	N/A	N/A
03 Key Retracts Latch pull trim	2703C	\$2,746.00	N/A	\$2,618.00	\$2,933.00	\$3,231.00
	2703Z	\$2,997.00	N/A	*	N/A	N/A
03 Key Retracts Latch cylinder trim	2703W	\$2,658.00	N/A	*	\$2,835.00	\$3,131.00
	2703WS	*	N/A	*	*	*
		630/626	628/626	* Contact Factory for Availability		
01 Blank Escutcheon	2701D	\$2,910.00	N/A	\$2,797.00	\$3,117.00	\$3,420.00
02 Dummy Lever Trim	2702D	\$2,910.00	N/A	\$2,797.00	\$3,117.00	\$3,420.00
08 Key Locks/Unlocks Outside Lever	2708D	\$2,950.00	N/A	\$2,841.00	\$3,197.00	\$3,501.00
09 Lever Trim Active by key; Locked when key removed	2709D	\$2,950.00	N/A	\$2,841.00	\$3,197.00	\$3,501.00
14 Outside Lever Always Active	2714D	\$2,950.00	N/A	\$2,841.00	\$3,197.00	\$3,501.00
EU Electric Lock/Unlock	27EU	\$3,436.00	N/A	\$3,370.00	\$3,692.00	\$3,985.00

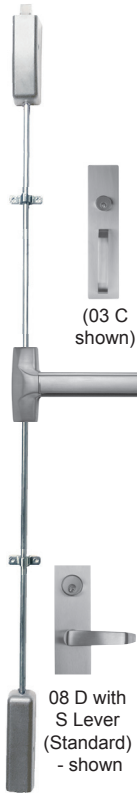

NOTE:
For all trim information and graphics see page 17

Note: Devices are shipped RHR unless specified LHR (Field Reversible)

DEVICE COMES STANDARD WITH:

Latch Covers	HD Hex Dogging	
Same finish, device exterior (except 628 finish which includes stainless steel pushpad and endcap)	36" 36" Device for 3 foot doors	
EC1 Ramped Endcap - Heavy Duty (standard on 630, 606, 612, 613, 605, 611 & 629 finishes only)	84" 84" Device for 7 foot doors	(95B Bottom Strike)
EC2 Flush Endcap (standard on 628, 693 & 695 finishes only)		(999T Top Strike)

OPTIONS

(N/C* - No charge when ordered with device)

T Tornado Rated (door must be up to 42" wide and 88" tall only)	Add \$75.00
F Fire Rated (Contact Factory)	Add \$125.00
W Weatherized (Mechanical only - For weatherized electrified functions, see Electrified Options)	Add \$79.00
For Electrified Options see pages 36-41	
Custom lengths - Specify size (min. 24" to max. 48")	Add \$75.00
Note: See Electrified Options for availability on devices shorter than 30", certain sizes require EC2 endcap	
48" 48" Device for 4'0" doors	Add \$31.00
96" Add for 8' doors	Add \$20.00
120" Add for 10' doors	Add \$50.00
AM Anti-Microbial (Pushpad, pull handles, and lever handles only)	Add \$60.00
KS Key Stop Installed	Add \$5.00
SLR Silent Pushpad Return	Add \$75.00
CD Cylinder Dogging (Cylinder Dogging and Hex Dogging not available with Tornado Rated Device - Contact factory for dogging options)	N/C*
	N/C*
LD Less Dogging	
RCBG Rod Covers / Bolt Guards	Contact Factory

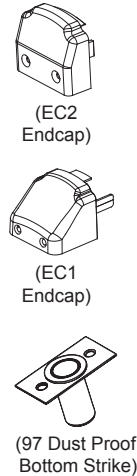

NOTE - Cylinders not included. Products on this page can be ordered with cylinders (C65) or Interchangeable core housings (IC7) pre-installed at Detex prior to shipping (See page 47).

NOTE - When vertical rod devices are used on both doors of a pair, operation of the inactive door (smaller door) will not disengage the active door, creating a potential safety issue for those using the inactive door during an emergency.



30 SERIES MORTISE LOCK EXIT DEVICE

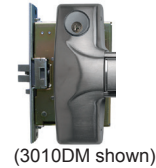

NOTE:
For all trim information and graphics see page 17

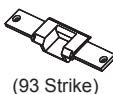
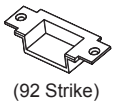
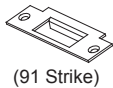
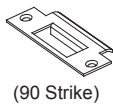
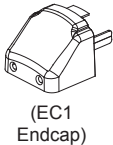
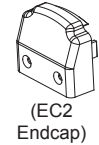

Finishes

Outside Function	Device	Finishes				
		630 (Std.)	628	693, 695	606, 612, 613	605, 611, 629
Device Only - Exit Only No Trim	30	\$ 1,640.00	\$ 1,459.00	\$ 1,532.00	\$ 1,685.00	\$ 1,870.00
	Device/ Function/Trim	630/630	628/630			
01 Exit only, cover plate	3001CM	\$1,782.00	\$1,601.00	\$1,686.00	\$1,844.00	\$2,032.00
	3001WM	\$1,800.00	\$1,619.00	*	\$1,861.00	\$2,046.00
02 Dummy pull trim	3002CM	\$1,859.00	\$1,678.00	\$1,771.00	\$1,931.00	\$2,121.00
03 Key Retracts Latch pull trim	3003CM	\$1,888.00	\$1,707.00	\$1,802.00	\$1,963.00	\$2,153.00
03 Key Retracts Latch cylinder trim	3003WM	\$1,800.00	\$1,619.00	*	\$1,865.00	\$2,053.00
		630/626	628/626	* Contact Factory for Availability		
01 Blank Escutcheon	3001DM	\$2,052.00	\$1,871.00	\$1,981.00	\$2,147.00	\$2,342.00
02 Dummy Lever Trim	3002DM	\$2,052.00	\$1,871.00	\$1,981.00	\$2,147.00	\$2,342.00
08 Key Locks/Unlocks Outside Lever	3008DM	\$2,092.00	\$1,911.00	\$2,025.00	\$2,227.00	\$2,423.00
09 Lever Trim Active by Key; Locked when key removed	3009DM	\$2,092.00	\$1,911.00	\$2,025.00	\$2,227.00	\$2,423.00
10 Double Cylinder	3010DM	\$2,309.00	\$2,128.00	\$2,261.00	\$2,436.00	\$2,636.00
14 Outside Lever Always Active	3014DM	\$2,092.00	\$1,911.00	\$2,025.00	\$2,227.00	\$2,423.00
EU Electric Lock/Unlock	30EUxDM	\$2,578.00	\$2,397.00	\$2,643.00	\$2,722.00	\$2,907.00

NOTE: Specify -M for Mortise Trim

DEVICE COMES STANDARD WITH:

Same finish, device exterior (except 628 finish which includes stainless steel cover, pushpad and endcap) HD Hex Dogging
 EC1 Ramped Endcap - Heavy Duty (standard on 630, 606, 612, 613, 605, 611 & 629 finishes only) 36" 36" Device for 3 foot doors
 EC2 Flush Endcap (standard on 628, 693 & 695 finishes only) 90 Non-Handed Curved Lip Strike











OPTIONS

(N/C* - No charge when ordered with device)







F Fire Rated - Specify prefix F (ex. F3001)	Add \$125.00
For Electrified Options see pages 36-41	
Custom lengths - Specify size (min. 26" to max. 48")	Add \$75.00
Note: See Electrified Options for availability on devices shorter than 30", certain sizes require EC2 endcap	
48" 48" Device for 4'0" doors	Add \$31.00
AM Anti-Microbial (Pushpad, pull handles, and lever handles only)	Add \$60.00
KS Key Stop Installed	Add \$5.00
SLR Silent Pushpad Return	Add \$75.00
CD Cylinder Dogging	N/C*
LD Less Dogging	N/C*
91 ANSI Flat Lip Strike	Add \$5.00
92 Double Door Short Open Back Strike	Add \$33.00
93 Double Door Long Open Back Strike	Add \$29.00

NOTE - Cylinders not included. Products on this page can be ordered with cylinders (C65) or interchangeable core housings (IC7) pre-installed at Detex prior to shipping (See page 47).

PLATES AND PULL TRIMS

W Trim for 10/20/21 Series Devices WM Trim (30 Series)		WS Trim for 10/20/21 Series Devices	C Trim for 10/20/21 Series Devices CM Trim (30 Series) S Handle			Z Trim for 10/20/21 Series Devices		
 01W/ 01WM	 03W/ 03WM	 03WS	 01C/ 01CM	 02C/ 02CM	 03C/ 03CM	 02Z	 03Z Specify Handing	
			Finishes					
Function	Description	Trim	630** (Std.)	693, 695	606, 612, 613	605, 611, 629		
01	Exit only, cover plate	W, WM	\$160.00	\$175.00	\$180.00	\$184.00		
03*	Key retracts latch	W, WM	\$160.00	\$175.00	\$180.00	\$184.00		
03*	Key retracts latch	WS**	\$145.00	\$158.00	\$188.00	\$192.00		
01	Exit only, cover plate	C, CM	\$142.00	\$156.00	\$159.00	\$162.00		
02	Dummy pull	C, CM	\$219.00	\$239.00	\$246.00	\$251.00		
03*	Key retracts latch	C, CM	\$248.00	\$270.00	\$278.00	\$284.00		
02	Dummy vandal pull	Z	\$576.00	N/A	N/A	N/A		
03*	Key retracts latch vandal pull	Z	\$499.00	N/A	N/A	N/A		
* Rim cylinder not included (order separately - see page 47)					RC65  IC7R 			
** WS Trim - Not available in Stainless Steel (630) - Specify 625 or 626 (626 - same price as 630)								
NOTE: 02Z and 03Z Trims are shipped RHR unless specified LHR								

LEVER TRIM

D & EU Trim - for 10/20/21 Series Devices DM & EU Trim - for 30 Series Device							
 EU, 08, 09D/DM	 02, 14D/DM	 S Lever - Standard	For Contemporary/ European Designed FSB Levers, see page 18				
		 T Lever					
		 U Lever					
				Finishes			
Function	Description	Trim	Lever	626** (Std.)	693, 695	606, 612, 613	605, 611, 629
01	Blank Escutcheon	D, DM	N/A	\$412.00	\$449.00	\$462.00	\$472.00
02	Dummy lever	D, DM	S, T or U	\$412.00	\$449.00	\$462.00	\$472.00
08*	Key locks/unlocks outside lever	D, DM	S, T or U	\$452.00	\$493.00	\$542.00	\$553.00
09*	Lever trim active by key; locked when key removed	D, DM	S, T or U	\$452.00	\$493.00	\$542.00	\$553.00
14	Outside lever always active	D, DM	S, T or U	\$452.00	\$493.00	\$542.00	\$553.00
EU*	Electric Lock/Unlock	EU, EUxDM	S, T or U	\$938.00	\$1,022.00	\$1,037.00	\$1,037.00
(For EU specify Fail Secure [FSE - std.] or Fail Safe [FSA] and specify handing - not field reversible)							
Kaba Mechanical & Electronic Push Button Access Control Lever Trim - Sold with Exit Device Only (See EasyKit/Access Control Doors/ACD Section)							
* Mortise cylinder not included (order separately - see page 47)			MC65  IC7 				
NOTE: Lever Trims are shipped RHR unless specified LHR (02, 08, 09 and 14 are Field Reversible)							



103789 Cylinder Nut Socket
100783 Cylinder Nut
See page 96 for more information

Wide Stile FSB Levers For Use With 10/20/21/27/30/70/71/80/81/82/83/87 Series

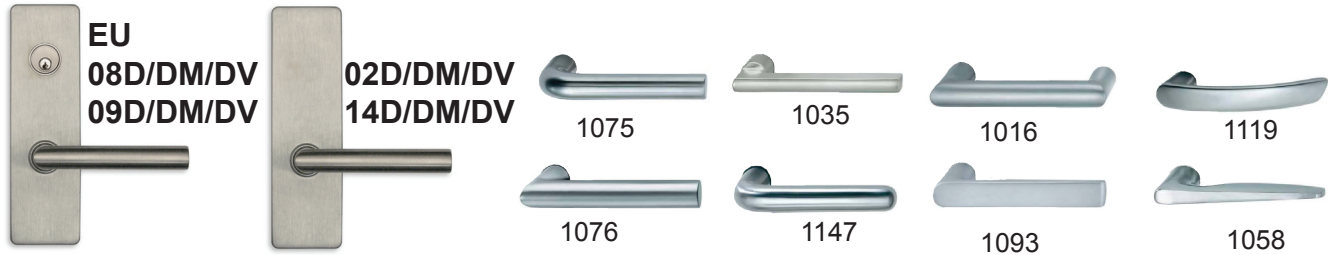

				Finishes			
Function	Description	Trim	Lever	630** (Std.)	693, 695	606, 612, 613	605, 611, 629
02	Dummy lever	D, DM	FSB_ _ _ _ †	\$838.00	Contact factory for additional levers and finishes.		
08*	Key locks/unlocks outside lever	D, DM	FSB_ _ _ _ †	\$878.00			
09*	Lever trim active by key; locked when key removed	D, DM	FSB_ _ _ _ †	\$878.00			
14	Outside lever always active	D, DM	FSB_ _ _ _ †	\$878.00			
EU*	Electric Lock/Unlock	EU, EUxDM	FSB_ _ _ _ †	\$1,364.00			

(For EU specify Fail Secure [FSE - std.] or Fail Safe [FSA] and specify handing - not field reversible)

FSB Lever Trims available in 630 / &S32D Brushed Stainless Steel finish only

* Mortise cylinder not included (order separately - see page 47)

NOTE: Lever Trims are shipped RHR unless specified LHR (02, 08, 09 and 14 are Field Reversible)

† To order, use FSB then 4 letter designator. (Example: FSB1076)

Narrow Stile FSB Levers For Use With 40/50/51/60/61/62/63 Series

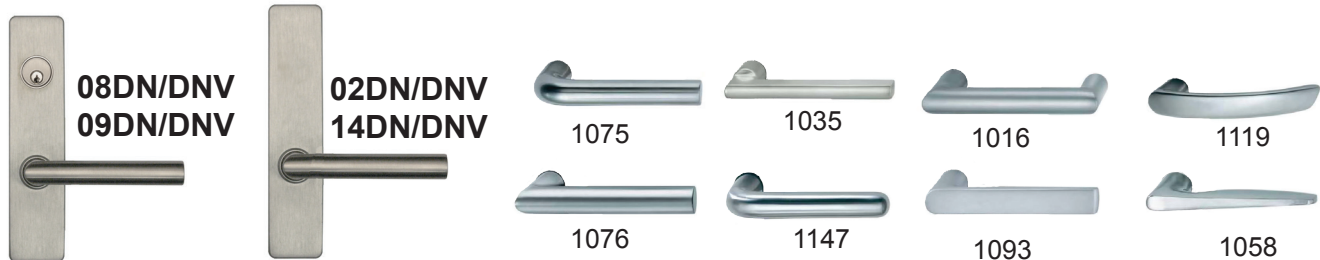

				Finishes			
Function	Description	Trim	Lever	630** (Std.)	693, 695	606, 612, 613	605, 611, 629
02	Dummy lever	D, DN	FSB_ _ _ _ †	\$838.00	Contact factory for additional levers and finishes.		
08*	Key locks/unlocks outside lever	D, DN	FSB_ _ _ _ †	\$878.00			
09*	Lever trim active by key; locked when key removed	D, DN	FSB_ _ _ _ †	\$878.00			
14	Outside lever always active	D, DN	FSB_ _ _ _ †	\$878.00			

(For EU specify Fail Secure [FSE - std.] or Fail Safe [FSA] and specify handing - not field reversible)

FSB Lever Trims available in 630 / &S32D Brushed Stainless Steel finish only

* Mortise cylinder not included (order separately - see page 47)

NOTE: Lever Trims are shipped RHR unless specified LHR (02, 08, 09 and 14 are Field Reversible)

† To order, use FSB then 4 letter designator. (Example: FSB1076)

40 SERIES NARROW STILE RIM EXIT DEVICE



(03 CN shown)



08 DN with S Lever (Standard) - shown

NOTE:
For all trim information and graphics see page 21



(EC2 Endcap)

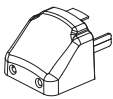

(EC1 Endcap)

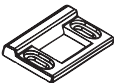

(98 Strike)

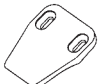

(94 Strike)



(99 Strike)

MC65

IC7

RC65

IC7R



Finishes

Outside Function	Device	630 (Std.)	628	693, 695	606, 612, 613	605, 611, 629
Device Only - Exit Only No Trim	40	\$1,258.00	\$1,085.00	\$1,150.00	\$1,300.00	\$1,520.00
	Device/Function/Trim	630/630	628/630			
01 Exit only, cover plate	4001CN	\$1,411.00	\$1,238.00	\$1,317.00	\$1,482.00	\$1,705.00
02 Dummy pull trim	4002CN	\$1,477.00	\$1,304.00	\$1,389.00	\$1,561.00	\$1,786.00
03 Key Retracts Latch pull trim	4003CN	\$1,506.00	\$1,333.00	\$1,420.00	\$1,594.00	\$1,820.00
03 Key Retracts Latch cylinder trim	4003WS	\$1,403.00	\$1,230.00	*	\$1,488.00	\$1,712.00
		630/626	628/626	* Contact Factory for Availability		
01 Blank Escutcheon	4001DN	\$1,670.00	\$1,497.00	\$1,599.00	\$1,762.00	\$1,992.00
02 Dummy Lever Trim	4002DN	\$1,670.00	\$1,497.00	\$1,599.00	\$1,762.00	\$1,992.00
08 Key Locks/Unlocks Outside Lever	4008DN	\$1,710.00	\$1,537.00	\$1,643.00	\$1,842.00	\$2,073.00
09 Lever Trim Active by Key; Locked when key removed	4009DN	\$1,710.00	\$1,537.00	\$1,643.00	\$1,842.00	\$2,073.00
14 Outside Lever Always Active	4014DN	\$1,710.00	\$1,537.00	\$1,643.00	\$1,842.00	\$2,073.00
EU2W Electric Lock/Unlock	40EU2W	\$2,196.00	\$2,023.00	\$2,643.00	\$2,337.00	\$2,557.00

Special Note: Specify EU2W trim for Hollow Metal Door, fits doors with minimum 4" (or greater) stile

DEVICE COMES STANDARD WITH:

Same finish, device exterior (except 628 finish which includes stainless steel pushpad and endcap)	HD Hex Dogging 36" 36" Device for 3 foot doors
EC1 Ramped Endcap - Heavy Duty (standard on 630, 606, 612, 613, 605, 611 & 629 finishes only)	98 Semi-Mortise Strike Extended Extrusion
EC2 Flush Endcap (standard on 628, 693 & 695 finishes only)	

NOTE: For 2" stile doors, specify EC2

OPTIONS

(N/C* - No charge when ordered with device)

F Fire Rated - Specify prefix F (ex. F4001)	Add \$125.00
H Hurricane Rated - Specify prefix H (ex. H4001)	Add \$75.00
FH Fire Rated/Hurricane Rated - Specify prefix FH (ex. FH4001)	Add \$200.00
W Weatherized (Mechanical only - For weatherized electrified functions, see Electrified Options)	Add \$79.00
Electrified Options - see pages 36-41	
Custom lengths - Specify size (min. 24" to max. 48")	Add \$75.00
Note: See Electrified Options for availability on devices shorter than 30", certain sizes require EC2 endcap	
48" 48" Device for 4'0" doors	Add \$31.00
AM Anti-Microbial (Pushpad, pull handles, and lever handles only)	Add \$60.00
KS Key Stop Installed	Add \$5.00
SLR Silent Pushpad Return	Add \$75.00
CD Cylinder Dogging	N/C*
LD Less Dogging	N/C*
94 Double Door Strike Available - see page 46	
99 Surface Strike	N/C*

NOTE - Cylinders not included. Products on this page can be ordered with cylinders (C65) or Interchangeable core housings (IC7) pre-installed at Detex prior to shipping (See page 47).

Where Trust is Built™

50/51 SERIES NARROW STILE SURFACE VERTICAL ROD EXIT DEVICES



Outside Function	Top & Bottom Rod Device	Top Rod Only Device	Finishes					
			630 (Std.)	628	693, 695	606, 612, 613	605, 611, 629	
Device Only - Exit Only No Trim	50	51	\$1,891.00	\$1,610.00	\$1,723.00	\$1,947.00	\$2,104.00	
			Device/Function/Trim		630/630		628/630	
(50 Series shown)	01 Exit only, cover plate	5001CN	5101CN	\$2,044.00	\$1,763.00	\$1,889.00	\$2,129.00	\$2,289.00
	02 Dummy pull trim	5002CN	5102CN	\$2,110.00	\$1,829.00	\$1,962.00	\$2,208.00	\$2,370.00
	03 Key Retracts Latch pull trim	5003CN	5103CN	\$2,139.00	\$1,858.00	\$1,993.00	\$2,241.00	\$2,404.00
	03 Key Retracts Latch cylinder trim	5003WS	5103WS	\$2,036.00	\$1,755.00	\$2,643.00	\$2,135.00	\$2,296.00
			630/626	628/626	* Contact Factory for Availability			
	01 Blank Escutcheon	5001DN	5101DN	\$2,303.00	\$2,022.00	\$2,172.00	\$2,409.00	\$2,576.00
	02 Dummy Lever Trim	5002DN	5102DN	\$2,303.00	\$2,022.00	\$2,172.00	\$2,409.00	\$2,576.00
	08 Key Locks/Unlocks Outside Lever	5008DN	5108DN	\$2,343.00	\$2,062.00	\$2,215.00	\$2,489.00	\$2,657.00
08 DN with S Lever (Standard) - shown	09 Lever Trim Active by Key; Locked when key removed	5009DN	5109DN	\$2,343.00	\$2,062.00	\$2,215.00	\$2,489.00	\$2,657.00
	14 Outside Lever Always Active	5014DN	5114DN	\$2,343.00	\$2,062.00	\$2,215.00	\$2,489.00	\$2,657.00
	EU2W Electric Lock/Unlock	50EU2W	51EU2W	\$2,829.00	\$2,548.00	\$2,643.00	\$2,984.00	\$3,141.00

NOTE:
For all trim information and graphics see page 21

Special Note: Specify EU2W trim for Hollow Metal Door, fits doors with minimum 4" (or greater) stile
Note: Devices are shipped RHR unless specified LHR (Field Reversible)

DEVICE COMES STANDARD WITH:

- Rod Covers
- Same finish, device exterior (except 628 finish which includes stainless steel cover, pushpad and endcap)
- EC1 Ramped Endcap - Heavy Duty (standard on 630, 606, 612, 613, 605, 611 & 629 finishes only)
- EC2 Flush Endcap (standard on 628, 693 & 695 finishes only)
- NOTE: For 2" stile doors, specify EC2
- HD Hex Dogging
- 36" 36" Device for 3 foot doors
- 84" 84" Rods for 7 foot doors
- 96 Surface Strike
- 96 Dust Proof Bottom Strike (50 Series only)
- Extended Extrusion

OPTIONS

(N/C* - No charge when ordered with device)

- F Fire Rated - Specify prefix F (ex. F5001) - Fire pin included for 51 Series Only Add \$125.00
- W Weatherized (Mechanical only - For weatherized electrified functions, see Electrified Options) Add \$79.00
- For Electrified Options see pages 36-41**
- Custom lengths - Specify size (min. 24" to max. 48") Add \$75.00
- Note: See Electrified Options for availability on devices shorter than 30", certain sizes require EC2 endcap
- 48" 48" Device for 4'0" doors Add \$31.00
- 96" Add for 8' doors Add \$20.00
- 120" Add for 10' doors Add \$50.00
- AM Anti-Microbial (Pushpad, pull handles, and lever handles only) Add \$60.00
- KS Key Stop Installed Add \$5.00
- SLR Silent Pushpad Return Add \$75.00
- CD Cylinder Dogging N/C*
- LD Less Dogging N/C*

NOTE - Cylinders not included. Products on this page can be ordered with cylinders (C65) or Interchangeable core housings (IC7) pre-installed at Detex prior to shipping (See page 47).

NOTE - Application note for 2' device (Available on Surface Vertical Device. Will ship less UL Fire label):
 When vertical rod devices are used on both doors of a pair, operation of the inactive door (smaller door) will not disengage the active door, creating a potential safety issue for those using the inactive door during an emergency.



(EC2 Endcap)

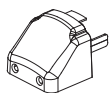

(EC1 Endcap)



(96 Surface Strike)

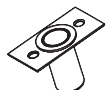





(96 Dust Proof Bottom Strike)







NARROW STILE TRIM DESIGNS FOR 40/50/51 SERIES DEVICES







PLATES AND PULL TRIMS

WS Trim for 40/50/51 Series Devices			CN Trim for 40/50/51 Series Devices S Handle			
 03WS			 01CN  02CN  03CN			
			Finishes			
Function	Description	Trim	630** (Std.)	693, 695	606, 612, 613	605, 611, 629
03*	Key retracts latch	WS**	\$145.00	\$158.00	\$188.00	\$192.00
01	Exit only, cover plate	CN	\$153.00	\$167.00	\$182.00	\$185.00
02	Dummy pull	CN	\$219.00	\$239.00	\$260.00	\$265.00
03*	Key retracts latch	CN	\$248.00	\$270.00	\$295.00	\$301.00

* Rim cylinder not included (order separately - see page 47)
 ** WS Trim - Not available in Stainless Steel (630) - Specify 625 or 626 (626 - same price as 630)



 RC65  IC7R

LEVER TRIM NARROW STILE

DN & EU2W Trim for 40/50/51 Series Devices							
 08, 09DN		 02, 14DN		 S Lever - Standard  T Lever  U Lever		 EU2W For Contemporary/ European Designed FSB Levers, see page 18	
				Finishes			
Function	Description	Trim	Lever	626** (Std.)	693, 695	606, 612, 613	605, 611, 629
01	Blank Escutcheon	DN	N/A	\$412.00	\$449.00	\$462.00	\$472.00
02	Dummy lever	DN	S, T or U	\$412.00	\$449.00	\$462.00	\$472.00
08*	Key locks/unlocks outside lever	DN	S, T or U	\$452.00	\$493.00	\$542.00	\$553.00
09*	Lever trim active by key; locked when key removed	DN	S, T or U	\$452.00	\$493.00	\$542.00	\$553.00
14	Outside lever always active	DN	S, T or U	\$452.00	\$493.00	\$542.00	\$553.00
EU2W*	Electric Lock/Unlock Wide Escutcheon	EU2W	S, T or U	\$938.00	\$1,022.00	\$1,037.00	\$1,037.00

(For EU2W specify Fail Secure [FSE - std.] or Fail Safe [FSA] and specify handing - not field reversible)

Contact factory for Vandal Resistant Lever
 Special Note: Specify EU2W trim for Hollow Metal Door, fits doors with minimum 4" (or greater) stile
 * Mortise cylinder not included (order separately - see page 47)

 MC65  IC7

NOTE: Lever Trims are shipped RHR unless specified LHR (02, 08, 09 and 14 are Field Reversible)



103789 Cylinder Nut Socket
 100783 Cylinder Nut
 See page 96 for more information



60/61 SERIES CONCEALED VERTICAL ROD EXIT DEVICES (NARROW STILE FOR ALUMINUM DOOR)



(60 Series shown)

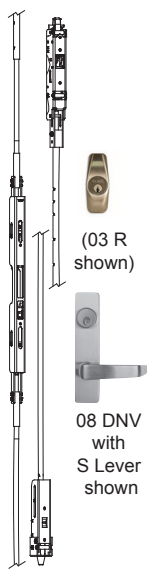

Outside Function	Top & Bottom Rod Device	Top Rod Only Device	Finishes					
			630 (Std.)	628	693, 695	606, 612, 613	605, 611, 629	
Device Only - Exit Only No Trim	60	61	\$2,006.00	\$1,704.00	\$1,823.00	\$2,208.00	\$2,468.00	
	Device/Function/Trim		630/630	628/630				
02 Dummy pull trim	6002WP	6102WP	\$2,205.00	\$1,903.00	*	*	*	
03 Key Retracts Latch cylinder trim	6003R	6103R	\$2,302.00	\$2,000.00	*	*	*	
			630/626	628/626	* Contact Factory for Availability			
02 Dummy Lever Trim	6002DNV	6102DNV	\$2,492.00	\$2,190.00	\$2,308.00	\$2,741.00	\$3,025.00	
08 Key Locks/Unlocks Outside Lever	6008DNV	6108DNV	\$2,539.00	\$2,237.00	\$2,419.00	\$2,793.00	\$3,120.00	
09 Lever Trim Active by Key; Locked when key removed	6009DNV	6109DNV	\$2,539.00	\$2,237.00	\$2,419.00	\$2,793.00	\$3,120.00	
14 Outside Lever Always Active	6014DNV	6114DNV	\$2,539.00	\$2,237.00	\$2,419.00	\$2,793.00	\$3,120.00	

NOTE:

For all trim information and graphics see page 24

Note: Devices are shipped RHR unless specified LHR (Field Reversible)

DEVICE COMES STANDARD WITH:

Same finish, device exterior (except 628 finish which includes stainless steel cover, pushpad and endcap)
 EC1 Ramped Endcap - Heavy Duty (standard on 630, 606, 612, 613, 605, 611 & 629 finishes only)
 EC2 Flush Endcap (standard on 628, 693 & 695 finishes only)
 NOTE: For 2" stile doors, specify EC2

HD Hex Dogging
 36" 36" Device for 3 foot doors
 80" - 96" Fits 6'8" to 8' doors
 95T Top Strike
 95B Bottom Strike (60 Series Only)

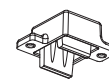

(95T Top Strike)



(95B Bottom Strike)

OPTIONS

(N/C* - No charge when ordered with device)

F Fire Rated (3 Hour) with steel door - Specify prefix F (ex. F6001) - Fire pin included for 61 Series Only	Add \$125.00
For Electrified Options see pages 36-41	
48" 48" Device for 4'0" doors	Add \$31.00
Custom lengths - Specify size (min. 24" to max. 48")	Add \$75.00
Note: See Electrified Options for availability on devices shorter than 30"	
120" Add for 10' doors	Add \$50.00
AM Anti-Microbial (Pushpad, pull handles, and lever handles only)	Add \$60.00
KS Key Stop Installed	Add \$5.00
SLR Silent Pushpad Return	Add \$75.00
CD Cylinder Dogging	N/C*
LD Less Dogging	N/C*
96B Dust Proof Strike	Add \$36.00

NOTE - Cylinders not included. Products on this page can be ordered with cylinders (C65) or interchangeable core housings (IC7) pre-installed at Detex prior to shipping (See page 47).



62/63 SERIES CONCEALED VERTICAL ROD EXIT DEVICES (NARROW STILE FOR HOLLOW METAL DOOR)



(62 Series shown)

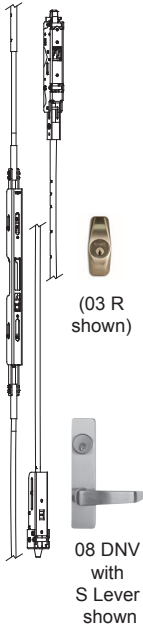

Outside Function	Top & Bottom Rod Device	Top Rod Only Device	Finishes					
			630 (Std.)	628	693, 695	606, 612, 613	605, 611, 629	
Device Only - Exit Only No Trim	62	63	\$2,006.00	\$1,704.00	\$1,823.00	\$2,208.00	\$2,468.00	
Device/Function/Trim			630/630	628/630				
01 Exit only, cover plate	6201CNV	6301CNV	\$2,187.00	\$1,885.00	\$2,025.00	\$2,405.00	\$2,687.00	
02 Dummy pull trim	6202CNV 6202WP	6302CNV 6202WP	\$2,265.00 \$2,205.00	\$1,963.00 \$1,903.00	\$2,113.00 *	\$2,491.00 *	\$2,782.00 *	
03 Key Retracts Latch pull trim	6203CNV	6303CNV	\$2,298.00	\$1,996.00	\$2,150.00	\$2,528.00	\$2,822.00	
03 Key Retracts Latch cylinder trim	6203R	6303R	\$2,302.00	\$2,000.00	*	*	*	
			630/626	628/626	* Contact Factory for Availability			
02 Dummy Lever Trim	6202DNV	6302DNV	\$2,492.00	\$2,190.00	\$2,308.00	\$2,741.00	\$3,025.00	
08 Key Locks/Unlocks Outside Lever	6208DNV	6308DNV	\$2,539.00	\$2,237.00	\$2,419.00	\$2,793.00	\$3,120.00	
09 Lever Trim Active by Key; Locked when key removed	6209DNV	6309DNV	\$2,539.00	\$2,237.00	\$2,419.00	\$2,793.00	\$3,120.00	
14 Outside Lever Always Active	6214DNV	6314DNV	\$2,539.00	\$2,237.00	\$2,419.00	\$2,793.00	\$3,120.00	

NOTE:
For all trim information and graphics see page 24

Note: Devices are shipped RHR unless specified LHR (Field Reversible)

DEVICE COMES STANDARD WITH:

- Same finish, device exterior (except 628 finish which includes stainless steel cover, pushpad and endcap)
 - 36" 36" Device for 3 foot doors
 - EC1 Ramped Endcap - Heavy Duty (standard on 630, 606, 612, 613, 605, 611 & 629 finishes only)
 - EC2 Flush Endcap (standard on 628, 693 & 695 finishes only)
- NOTE:** Fits 3-1/2" stile door

- HD Hex Dogging
80" - 96" Fits 6'8" to 8' doors
- 95T Top Strike
- 95B Bottom Strike (62 Series Only)

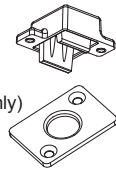

(95T Top Strike)
(95B Bottom Strike)

OPTIONS



(N/C* - No charge when ordered with device)

- F Fire Rated (3 Hour) - Specify prefix F (ex. F6201) - Fire pin included for 63 Series Only Add \$125.00
- For Electrified Options see pages 36-41**
- 48" 48" Device for 4'0" doors Add \$31.00
- Custom lengths - Specify size (min. 24" to max. 48") Add \$75.00
- Note: See Electrified Options for availability on devices shorter than 30"
- 120" Add for 10' doors Add \$50.00
- AM Anti-Microbial (Pushpad, pull handles, and lever handles only) Add \$60.00
- KS Key Stop Installed Add \$5.00
- SLR Silent Pushpad Return Add \$75.00
- CD Cylinder Dogging N/C*
- LD Less Dogging N/C*
- 96B Dust Proof Strike Add \$36.00

NOTE - Cylinders not included. Products on this page can be ordered with cylinders (C65) or interchangeable core housings (IC7) pre-installed at Detex prior to shipping (See page 47).



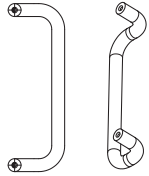



PLATES AND PULL TRIMS

R Trim for 60 Series Devices		WP Trim for 60 Series Devices		CNV Narrow Stile Trim for 62/63 Series Devices Only - S Handle			
 03R		 02WP		 01CNV 02CNV 03CNV			
				Finishes			
Function	Description	Trim	630** (Std.)	693, 695	606, 612, 613	605, 611, 629	
03*	Key retracts latch	R	\$296.00	N/A	N/A	N/A	
01	Exit only, cover plate	CNV	\$181.00	\$202.00	\$214.00	\$219.00	
02	Dummy pull	CNV	\$259.00	\$289.00	\$308.00	\$314.00	
02	Dummy pull (wire)	WP	\$199.00	N/A	N/A	N/A	
03*	Key retracts latch	CNV	\$292.00	\$326.00	\$347.00	\$354.00	

* Rim cylinder not included (order separately - see page 47)



LEVER TRIM

DNV Narrow Stile Trim - for 60 Series Device							
 08, 09 DNV		 02, 14 DNV		 S Lever - Standard		For Contemporary/ European Designed FSB Levers, see page 18	
				 T Lever			
				 U Lever			
				Finishes			
Function	Description	Trim	Lever	626** (Std.)	693, 695	606, 612, 613	605, 611, 629
01	Blank Escutcheon	DNV	S, T or U	\$486.00	\$485.00	\$490.00	\$557.00
02	Dummy lever	DNV	S, T or U	\$486.00	\$485.00	\$490.00	\$557.00
08*	Key locks/unlocks outside lever	DNV	S, T or U	\$533.00	\$596.00	\$639.00	\$652.00
09*	Lever trim active by key; locked when key removed	DNV	S, T or U	\$533.00	\$596.00	\$639.00	\$652.00
14	Outside lever always active	DNV	S, T or U	\$533.00	\$596.00	\$639.00	\$652.00

* Mortise cylinder not included (order separately - see page 47)

NOTE: Lever Trims are shipped RHR unless specified LHR (02, 08, 09 and 14 are Field Reversible)



103789 Cylinder Nut Socket
100783 Cylinder Nut
See page 96 for more information



Where Trust is Built™



70/71 SERIES CONCEALED VERTICAL ROD EXIT DEVICES (FOR WOOD DOOR)



(70 Series shown)

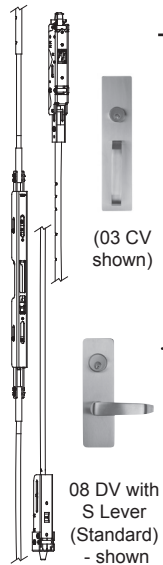

Outside Function	Bottom Rod Device	Top Rod Only Device	Finishes				
			630 (Std.)	628	693, 695	606, 612, 613	605, 611, 629
Device Only - Exit Only No Trim	70*	71*	\$2,029.00	\$1,758.00	\$1,863.00	\$2,232.00	\$2,494.00
Device/Function/Trim			630/630	628/630			
01 Exit only, cover plate	7001CV	7101CV	\$2,203.00	\$1,932.00	\$2,060.00	\$2,439.00	\$2,705.00
02 Dummy pull trim	7002CV	7102CV	\$2,279.00	\$2,008.00	\$2,146.00	\$2,529.00	\$2,797.00
	7002WP	7102WP	\$2,228.00	\$1,957.00	*	*	*
03 Key Retracts Latch pull trim	7003CV	7103CV	\$2,311.00	\$2,040.00	\$2,182.00	\$2,567.00	\$2,836.00
(03 CV shown) 03 Key Retracts Latch cylinder trim	7003WSV	7103WSV	\$2,199.00	\$1,928.00	*	\$2,455.00	\$2,717.00
			630/626	628/626	* Contact Factory for Availability		
02 Dummy Lever Trim	7002DV	7102DV	\$2,473.00	\$2,202.00	\$2,337.00	\$2,711.00	\$2,996.00
08 Key Locks/Unlocks Outside Lever	7008DV	7108DV	\$2,515.00	\$2,244.00	\$2,418.00	\$2,792.00	\$3,072.00
08 DV with S Lever (Standard) - shown	7009DV	7109DV	\$2,515.00	\$2,244.00	\$2,418.00	\$2,792.00	\$3,072.00
09 Lever Trim Active by Key; Locked when key removed	7009DV	7109DV	\$2,515.00	\$2,244.00	\$2,418.00	\$2,792.00	\$3,072.00
14 Outside Lever Always Active	7014DV	7114DV	\$2,515.00	\$2,244.00	\$2,418.00	\$2,792.00	\$3,072.00
EU Electric Lock/Unlock	70EUV	71EUV	\$3,098.00	\$2,827.00	\$2,886.00	\$3,414.00	\$3,676.00

NOTE:

For all trim information and graphics see page 29

Note: Devices are shipped RHR unless specified LHR (Field Reversible)
For Top Rod Only Device specify 71 (example 7101CV)
For high security or high traffic doors, 2" solid core door recommended

DEVICE COMES STANDARD WITH:

- Same finish, device exterior (except 628 finish which includes stainless steel cover, pushpad and endcap)
- 36" 36" Device for 3 foot doors
- EC1 Ramped Endcap - Heavy Duty (standard on 630, 606, 612, 613, 605, 611 & 629 finishes only)
- EC2 Flush Endcap (standard on 628, 693 & 695 finishes only)

- HD Hex Dogging
80" - 96" Fits 6'8" to 8' doors
- 95T Top Strike
- 95B Bottom Strike (70 Series Only)

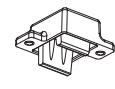

(95T Top Strike)

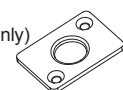

(95B Bottom Strike)

OPTIONS

(N/C* - No charge when ordered with device)

- F Fire Rated (Contact Factory) Contact Factory
- For Electrified Options see pages 36-41
- 48" 48" Device for 4'0" doors Add \$31.00
- Custom lengths - Specify size (min. 24" to max. 48") Add \$75.00
- Note: See Electrified Options for availability on devices shorter than 30", certain sizes require EC2 endcap
- 120" Add for doors 97" to 120" (10 ft) Add \$50.00
- AM Anti-Microbial (Pushpad, pull handles, and lever handles only) Add \$60.00
- KS Key Stop Installed Add \$5.00
- SLR Silent Pushpad Return Add \$75.00
- CD Cylinder Dogging N/C*
- LD Less Dogging N/C*
- 97 Dust Proof Strike Add \$36.00

NOTE - Cylinders not included. Products on this page can be ordered with cylinders (C65) or interchangeable core housings (IC7) pre-installed at Detex prior to shipping (See page 47).



80/81 SERIES CONCEALED VERTICAL ROD EXIT DEVICES (FOR HOLLOW METAL DOOR)



(80 Series shown)

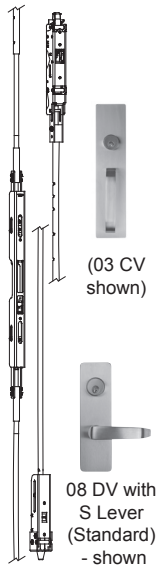

Outside Function	Top & Bottom Rod Device	Top Rod Only Device	Finishes				
			630 (Std.)	628	693, 695	606, 612, 613	605, 611, 629
Device Only - Exit Only No Trim	80*	81*	\$2,029.00	\$1,758.00	\$1,863.00	\$2,232.00	\$2,494.00
Device/Function/Trim			630/630	628/630	* Contact Factory for Availability		
01 Exit only, cover plate	8001CV	8101CV	\$2,203.00	\$1,932.00	\$2,060.00	\$2,439.00	\$2,705.00
02 Dummy pull trim	8002CV	8102CV	\$2,279.00	\$2,008.00	\$2,146.00	\$2,529.00	\$2,797.00
	8002WP	8102WP	\$2,224.00	\$1,953.00	*	*	*
03 Key Retracts Latch pull trim	8003CV	8103CV	\$2,311.00	\$2,040.00	\$2,182.00	\$2,567.00	\$2,836.00
03 Key Retracts Latch cylinder trim	8003WSV	8103WSV	\$2,199.00	\$1,928.00	*	\$2,455.00	\$2,717.00
			630/626	628/626	* Contact Factory for Availability		
02 Dummy Lever Trim	8002DV	8102DV	\$2,473.00	\$2,202.00	\$2,337.00	\$2,711.00	\$2,996.00
08 Key Locks/Unlocks Outside Lever	8008DV	8108DV	\$2,515.00	\$2,244.00	\$2,418.00	\$2,792.00	\$3,072.00
09 Lever Trim Active by Key; Locked when key removed	8009DV	8109DV	\$2,515.00	\$2,244.00	\$2,418.00	\$2,792.00	\$3,072.00
14 Outside Lever Always Active	8014DV	8114DV	\$2,515.00	\$2,244.00	\$2,418.00	\$2,792.00	\$3,072.00
EU Electric Lock/Unlock	80EUV	81EUV	\$3,098.00	\$2,827.00	\$2,886.00	\$3,414.00	\$3,676.00

NOTE:
For all trim information and graphics see page 29

**Note: Devices are shipped RHR unless specified LHR (Field Reversible)
For Top Rod Only Device specify 81 (example 8101CV)**

DEVICE COMES STANDARD WITH:

- Same finish, device exterior (except 628 finish which includes stainless steel cover, pushpad and endcap)
- 36" 36" Device for 3 foot doors
- EC1 Ramped Endcap - Heavy Duty (standard on 630, 606, 612, 613, 605, 611 & 629 finishes only)
- EC2 Flush Endcap (standard on 628, 693 & 695 finishes only)

- HD Hex Dogging
80" - 96" Fits 6'8" to 8' doors
- 95T Top Strike
- 95B Bottom Strike (80 Series Only)

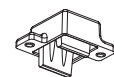

(95T Top Strike)

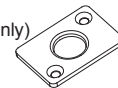

(95B Bottom Strike)

OPTIONS

(N/C* - No charge when ordered with device)

- F Fire Rated (3 Hour) - Specify prefix F (ex. F8001) - Fire pin included for 81 Series Only Add \$125.00
- For Electrified Options see pages 36-41
- 48" 48" Device for 4'0" doors Add \$31.00
- Custom lengths - Specify size (min. 24" to max. 48") Add \$75.00
- Note: See Electrified Options for availability on devices shorter than 30", certain sizes require EC2 endcap
- 120" Add for 10' doors Add \$50.00
- AM Anti-Microbial (Pushpad, pull handles, and lever handles only) Add \$60.00
- KS Key Stop Installed Add \$5.00
- SLR Silent Pushpad Return Add \$75.00
- CD Cylinder Dogging N/C*
- LD Less Dogging N/C*
- 97 Dust Proof Strike Add \$36.00

NOTE - Cylinders not included. Products on this page can be ordered with cylinders (C65) or interchangeable core housings (IC7) pre-installed at Detex prior to shipping (See page 47).



ADVANTEX®

82/83 SERIES CONCEALED VERTICAL ROD EXIT DEVICES (FOR ALUMINUM DOOR)



(82 Series shown)

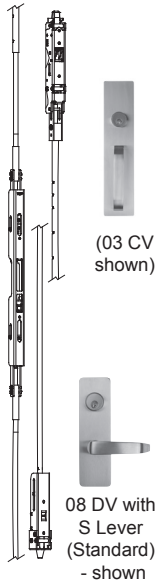

(03 CV shown)

08 DV with S Lever (Standard) - shown

NOTE:
For all trim information and graphics see page 29

Outside Function	Top & Bottom Rod Device	Top Rod Only Device	Finishes					
			630 (Std.)	628	693, 695	606, 612, 613	605, 611, 629	
Device Only - Exit Only No Trim	82*	83*	\$2,029.00	\$1,758.00	\$1,863.00	\$2,232.00	\$2,494.00	
Device/Function/Trim			630/630	628/630	* Contact Factory for Availability			
01 Exit only, cover plate	8201CV	8301CV	\$2,203.00	\$1,932.00	\$2,060.00	\$2,439.00	\$2,705.00	
02 Dummy pull trim	8202CV 8202WP	8302CV 8302WP	\$2,279.00 \$2,224.00	\$2,008.00 \$1,953.00	\$2,146.00 *	\$2,529.00 *	\$2,797.00 *	
03 Key Retracts Latch pull trim	8203CV	8303CV	\$2,311.00	\$2,040.00	\$2,182.00	\$2,567.00	\$2,836.00	
03 Key Retracts Latch cylinder trim	8203WSV	8303WSV	\$2,199.00	\$1,928.00	*	\$2,455.00	\$2,717.00	
02 Dummy Lever Trim	8202DV	8302DV	\$2,473.00	\$2,202.00	\$2,337.00	\$2,711.00	\$2,996.00	
08 Key Locks/Unlocks Outside Lever	8208DV	8308DV	\$2,515.00	\$2,244.00	\$2,418.00	\$2,792.00	\$3,072.00	
09 Lever Trim Active by Key; Locked when key removed	8209DV	8309DV	\$2,515.00	\$2,244.00	\$2,418.00	\$2,792.00	\$3,072.00	
14 Outside Lever Always Active	8214DV	8314DV	\$2,515.00	\$2,244.00	\$2,418.00	\$2,792.00	\$3,072.00	
EU Electric Lock/Unlock	82EUV	83EUV	\$3,098.00	\$2,827.00	\$2,886.00	\$3,414.00	\$3,676.00	

**Note: Devices are shipped RHR unless specified LHR (Field Reversible)
For Top Rod Only Device specify 83 (example 8301CV)**

DEVICE COMES STANDARD WITH:

Same finish, device exterior (except 628 finish which includes stainless steel cover, pushpad and endcap)
36" 36" Device for 3 foot doors
EC1 Ramped Endcap - Heavy Duty (standard on 630, 606, 612, 613, 605, 611 & 629 finishes only)
EC2 Flush Endcap (standard on 628, 693 & 695 finishes only)

HD Hex Dogging
80" - 96" Fits 6'8" to 8' doors
95T Top Strike
95B Bottom Strike (82 Series Only)

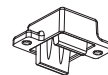

(95T Top Strike)

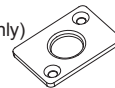

(95B Bottom Strike)

OPTIONS

(N/C* - No charge when ordered with device)

F Fire Rated (3 Hour) - Specify prefix F (ex. F8201) - Fire pin included for 83 Series Only

Add \$125.00

For Electrified Options see pages 36-41

48" 48" Device for 4'0" doors

Add \$31.00

Custom lengths - Specify size (min. 24" to max. 48")

Add \$75.00

Note: See Electrified Options for availability on devices shorter than 30", certain sizes require EC2 endcap

120" Add for 10' doors

Add \$50.00

AM Anti-Microbial (Pushpad, pull handles, and lever handles only)

Add \$60.00

KS Key Stop Installed

Add \$5.00

SLR Silent Pushpad Return

Add \$75.00

CD Cylinder Dogging

N/C*

LD Less Dogging

N/C*

97 Dust Proof Strike

Add \$36.00

NOTE - Cylinders not included. Products on this page can be ordered with cylinders (C65) or interchangeable core housings (IC7) pre-installed at Detex prior to shipping (See page 47).



87 SERIES HIGH SECURITY CONCEALED VERTICAL ROD EXIT DEVICE



(80 Series shown)

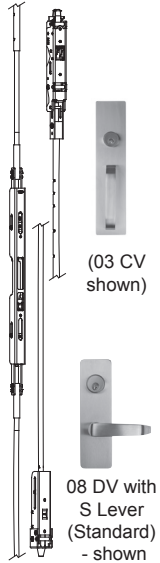

Outside Function	Top & Bottom Rod Device	Finishes				
		630 (Std.)	628	693, 695	606, 612, 613	605, 611, 629
Device Only - Exit Only No Trim	87*	\$2,929.00	N/A	\$2,748.00	\$3,222.00	\$3,603.00
	Device/Function/Trim	630/630				
01 Exit only, cover plate	8701CV	\$3,103.00	N/A	\$2,945.00	\$3,429.00	\$3,814.00
02 Dummy pull trim	8702CV 8702WP	\$3,179.00 \$3,124.00	N/A N/A	\$3,030.00 *	\$3,519.00 *	\$3,906.00 *
03 Key Retracts Latch pull trim	8703CV	\$3,211.00	N/A	\$3,066.00	\$3,557.00	\$3,945.00
03 Key Retracts Latch cylinder trim	8703WSV	\$3,099.00	N/A	N/A	\$3,445.00	\$3,826.00
		630/626		* Contact Factory for Availability		
02 Dummy Lever Trim	8702DV	\$3,373.00	N/A	\$3,222.00	\$3,701.00	\$4,105.00
08 Key Locks/Unlocks Outside Lever	8708DV	\$3,415.00	N/A	\$3,303.00	\$3,782.00	\$4,181.00
09 Lever Trim Active by Key; Locked when key removed	8709DV	\$3,415.00	N/A	\$3,303.00	\$3,782.00	\$4,181.00
14 Outside Lever Always Active	8714DV	\$3,415.00	N/A	\$3,303.00	\$3,782.00	\$4,181.00
EU Electric Lock/Unlock	87EUV	\$3,998.00	N/A	\$3,770.00	\$4,404.00	\$4,785.00

NOTE:
For all trim information and graphics see page 29

**Note: Devices are shipped RHR unless specified LHR (Field Reversible)
For Top Rod Only Device specify 81 (example 8101CV)
For high security or high traffic doors, 2" solid core door recommended**

DEVICE COMES STANDARD WITH:

- Same finish, device exterior (except 628 finish which includes stainless steel cover, pushpad and endcap)
- 36" 36" Device for 3 foot doors
- EC1 Ramped Endcap - Heavy Duty (standard on 630, 606, 612, 613, 605, 611 & 629 finishes only)
- EC2 Flush Endcap (standard on 628, 693 & 695 finishes only)

- HD Hex Dogging
80" - 96" Fits 6'8" to 8' doors
- 995T Top Strike
- 95B Bottom Strike

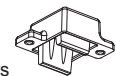

(995T Top Strike)

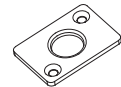

(95B Bottom Strike)

(N/C* - No charge when ordered with device)



OPTIONS

- T Tornado Rated (door must be up to 42" wide and 88" tall only) Add \$75.00
- F Fire Rated (Contact Factory) Add \$125.00
- For Electrified Options see pages 36-41**
- 48" 48" Device for 4'0" doors Add \$31.00
- Custom lengths - Specify size (min. 24" to max. 48") Add \$75.00
- Note: See Electrified Options for availability on devices shorter than 30", certain sizes require EC2 endcap
- 120" Add for 10' doors Add \$50.00
- AM Anti-Microbial (Pushpad, pull handles, and lever handles only) Add \$60.00
- KS Key Stop Installed Add \$5.00
- SLR Silent Pushpad Return Add \$75.00
- CD Cylinder Dogging (Cylinder Dogging and Hex Dogging not available with Tornado Rated Device - Contact factory for dogging options) N/C*
N/C*
- LD Less Dogging Add \$36.00
- 97 Dust Proof Bottom Strike
- RBCG Rod Covers / Bolt Guards Contact Factory

NOTE - Cylinders not included. Products on this page can be ordered with cylinders (C65) or interchangeable core housings (IC7) pre-installed at Detex prior to shipping (See page 47).



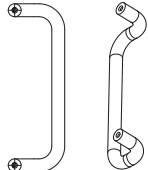



PLATES AND PULL TRIMS

WSV Trim for 70/80 Series Devices		WP Trim for 70/80 Series Devices		CV Trim for 70/80 Series Devices S Handle		
						
03WSV		02WP		01CV	02CV	03CV
				Finishes		
Function	Description	Trim	630** (Std.)	693, 695	606, 612, 613	605, 611, 629
03*	Key retracts latch	WSV**	\$170.00	N/A	\$223.00	\$223.00
02	Dummy pull (wire)	WP	\$199.00	N/A	N/A	N/A
01	Exit only, cover plate	CV	\$174.00	\$197.00	\$207.00	\$211.00
02	Dummy pull	CV	\$250.00	\$282.00	\$297.00	\$303.00
03*	Key retracts latch	CV	\$282.00	\$318.00	\$335.00	\$342.00

* Rim cylinder not included (order separately - see page 47)



LEVER TRIM

EUV and DV Trim - for 70/80 Series Devices							
						For Contemporary/ European Designed FSB Levers, see page 18	
							
							
				Finishes			
Function	Description	Trim	Lever	626** (Std.)	693, 695	606, 612, 613	605, 611, 629
01	Blank Escutcheon	DV	S, T or U	\$444.00	\$474.00	\$479.00	\$502.00
02	Dummy lever	DV	S, T or U	\$444.00	\$474.00	\$479.00	\$502.00
08*	Key locks/unlocks outside lever	DV	S, T or U	\$486.00	\$555.00	\$560.00	\$578.00
09*	Lever trim active by key; locked when key removed	DV	S, T or U	\$486.00	\$555.00	\$560.00	\$578.00
14	Outside lever always active	DV	S, T or U	\$486.00	\$555.00	\$560.00	\$578.00
EU*	Electric Lock/Unlock	EUV	S, T or U	\$1,069.00	\$1,022.00	\$1,182.00	\$1,182.00

(For EU specify Fail Secure [FSE - std.] or Fail Safe [FSA] and specify handing - not field reversible)

* Mortise cylinder not included (order separately - see page 47)

** Contact factory for availability

NOTE: Lever Trims are shipped RHR unless specified LHR (02, 08, 09 and 14 are Field Reversible)

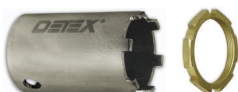

103789 Cylinder Nut Socket
100783 Cylinder Nut
See page 96 for more information

Where Trust is Built™

DETEX®
Life Safety, Security and Security Assurance

00/05 SERIES NO LATCH RAIL (NO MOVING PARTS)

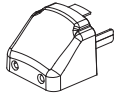

(EC1
Endcap)



(EC2
Endcap)

Function	Device	Finishes			
		628, 630	693, 695	606, 612, 613	605, 611, 629
00 Wide Stile, No moving parts, rail with 2 end caps	0000	\$600.00	\$600.00	\$875.00	\$951.00
05 Narrow Stile, No moving parts, rail with EC2 end caps	0500xEC2	\$749.00	\$749.00	\$1,024.00	\$1,100.00

For trim options, contact factory.



01 Series



04 Series

01/04 SERIES NO LATCH DUMMY BAR (ACTIVE PUSHPAD)

Outside Function	Device	Finishes			
		628, 630	693, 695	606, 612, 613	605, 611, 629
01 Active pushpad, std. head cover, no latch bolt	01	\$749.00	\$749.00	\$1,024.00	\$1,429.00
04 Active pushpad, narrow head cover, no latch bolt	04	\$854.00	\$854.00	\$1,129.00	\$1,520.00
	Device/ Function/Trim				
01 Active pushpad, std. head cover, no latch bolt	0101C	\$891.00	\$905.00	\$1,183.00	\$1,591.00
	0101W	\$909.00	\$924.00	\$1,204.00	\$1,613.00
	0102C	\$968.00	\$988.00	\$1,270.00	\$1,680.00
	0102D	\$1,161.00	\$1,198.00	\$1,486.00	\$1,901.00
04 Active pushpad, narrow head cover, no latch bolt	0401CN	\$1,007.00	\$1,021.00	\$1,311.00	\$1,705.00
	0402CN	\$1,073.00	\$1,093.00	\$1,389.00	\$1,785.00
	0402DN	\$1,266.00	\$1,303.00	\$1,591.00	\$1,992.00

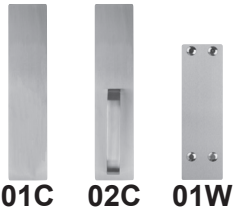

01C 02C 01W



01CN 02CN

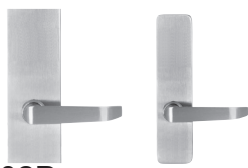

02D 02DN

OPTIONS

OPTIONS	Price
48" 48" Device for 4'0" doors	Add \$31.00
SLR Silent Pushpad Return (01 only)	Add \$75.00
W Weatherized (Mechanical only - For weatherized electrified functions, see Electrified Options)	Add \$79.00
For Electrified Options see pages 36-41	
Custom lengths - Specify size (min. 24" to max. 48")	Add \$75.00

ADVANTEX® HOW TO ORDER

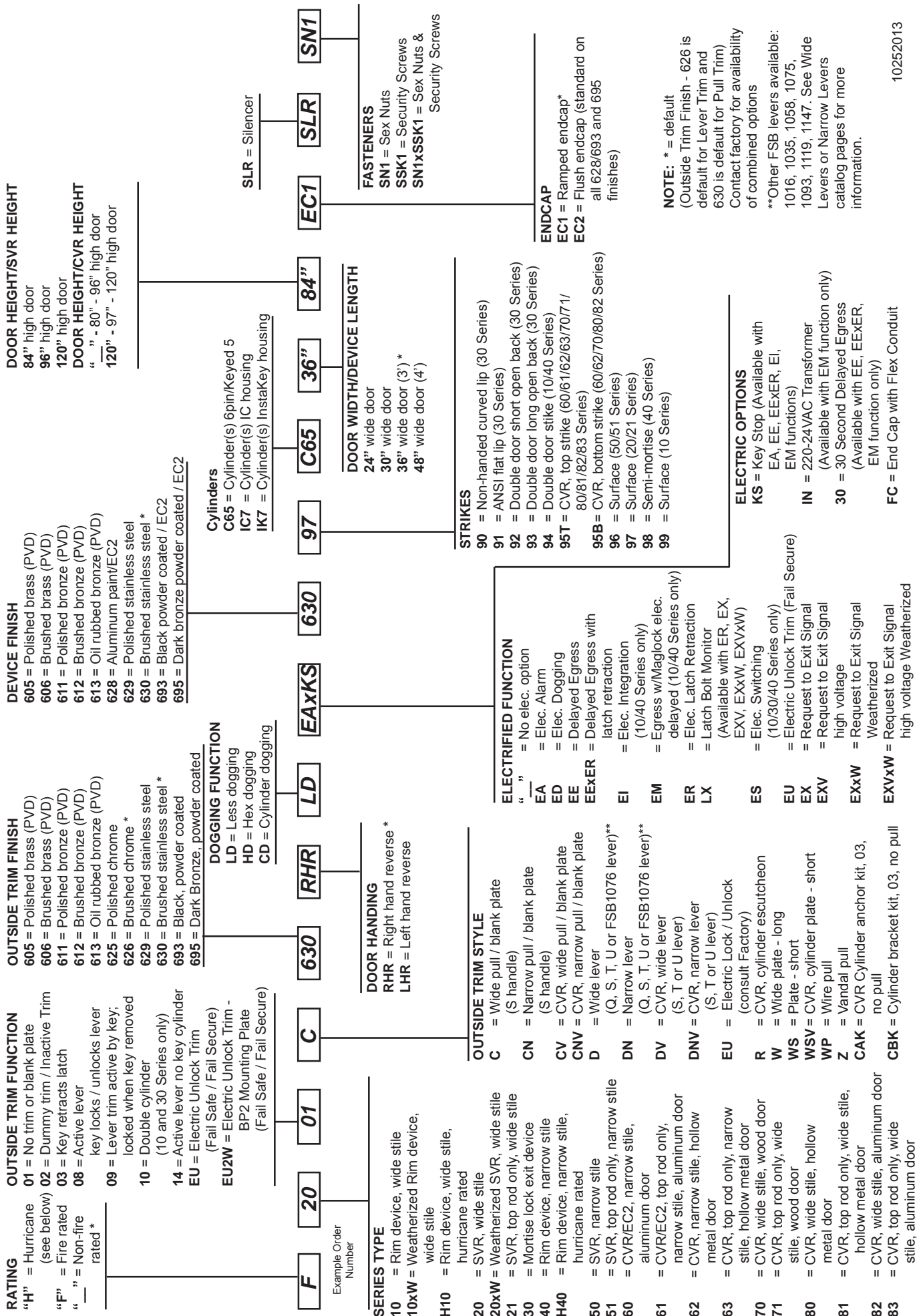

BHMA Function	BHMA Definition	Description	ADVANTEX®	Manufacturer #A Exit Devices	Manufacturer #B Exit Devices
			Standard 10 Series Rim	Standard 98 Series Rim	Standard 21 Series Rim
01	Exit Only	Cover Plate	01C & 01W	990EO	1701
02	Pull When Dogged	Dummy Pull	02C	990DT	1702A
02	Pull When Dogged	Dummy Vandal Pull	02Z	VR910DT	N/A
03	Key Retracts Latch Bolt	Night Latch Vandal Pull	03Z	VR910NL	N/A
03	Key Retracts Latch Bolt	Night Latch Pull	03C	990NL	1703A
03	Key Retracts Latch Bolt	Night Latch - Cylinder Only - Pull by Others	03WS & 03W	110NL-OP	C03
01	Exit Only	Blank Escutcheon	01D	996EO	N/A
02	Pull When Dogged	Dummy Lever	02D	996LxDT	4902A
08	Key Unlocks & Locks Lever	Classroom Lever	08D	996L	4908A
09	Lever Active by Key: Locked when key removed	Night Latch / Storeroom Lever	09D	996LxNL	4903A
10	Inside or outside, key locks or unlocks lever	Double Cylinder Lever	10D	996L-2	4908A
14	Lever always active	Passage Lever	14D	996LxBE	4914A
EU	Electric Lock/Unlock	Fail Secure or Fail Safe	EU	E996L	E4908A

BHMA Function	BHMA Definition	Description	SVR Rim 20/21 Series	SVR Rim 9827 Series	SVR Rim 22 Series
01	Exit Only	Cover Plate	01C & 01W	990EO	1701
02	Pull When Dogged	Dummy Pull	02C	990DT	1702A
02	Pull When Dogged	Dummy Vandal Pull	02Z	VR910DT	N/A
03	Key Retracts Latch Bolt	Night Latch Vandal Pull	03Z	VR910NL	N/A
03	Key Retracts Latch Bolt	Night Latch Pull	03C	990NL	1703A
03	Key Retracts Latch Bolt	Night Latch - Cylinder Only - Pull by Others	03WS & 03W	370T	C03
01	Exit Only	Blank Escutcheon	01D	N/A	N/A
02	Pull When Dogged	Dummy Lever	02D	996LxDT	4902A
08	Key Unlocks & Locks Lever	Classroom Lever	08D	996L-2	4908A
09	Lever Active by Key: Locked when key removed	Night Latch / Storeroom Lever	09D	996LxNL	4903A
14	Lever always active	Passage Lever	14D	996LxBE	4914A
EU	Electric Lock/Unlock	Fail Secure or Fail Safe	EU	E996L	E4908A

BHMA Function	BHMA Definition	Description	Mortise 30 Series	Mortise 9875 Series	Mortise 23 Series
01	Exit Only	Cover Plate	01CM, 01WM	990EO	1701
02	Pull When Dogged	Dummy Pull	02CM	990DT	1702A
03	Key Retracts Latch Bolt	Night Latch Pull	03CM	990NL	1703A
03	Key Retracts Latch Bolt	Night Latch - Cylinder Only - Pull by Others	03WM	990NL	C03
01	Exit Only	Blank Escutcheon	01DM	N/A	N/A
02	Pull When Dogged	Dummy Lever	02DM	996LxDT	M4902A
08	Key Unlocks & Locks Lever	Classroom Lever	08DM	996L	M4908A
09	Lever Active by Key: Locked when key removed	Night Latch / Storeroom Lever	09DM	996LxNL	M4903A
10	Inside or outside, key locks or unlocks lever	Double Cylinder Lever	10DM	996L-2	M4908A
14	Lever always active	Passage Lever	14DM	996LxBE	M4914A
EU	Electric Lock/Unlock	Fail Secure or Fail Safe	EUxDM	E996L	E4908A

Note: Detex Trims can be ordered separately from Detex Exit Devices

TRIM CROSS REFERENCE CONT'D ON PAGE 33

BHMA Function	BHMA Definition	Description	ADVANTEX®	Manufacturer #A Exit Devices	Manufacturer #B Exit Devices
			Narrow Stile 40 Series Rim	Narrow Stile 35A Series Rim	Narrow Stile 24 Series Rim
01	Exit Only	Cover Plate	01CN	360EO	2001
02	Pull When Dogged	Dummy Pull	02CN	386DT	2002A
03	Key Retracts Latch Bolt	Night Latch Pull	03CN	386NL	2003A
03	Key Retracts Latch Bolt	Night Latch - Cylinder Only - Pull by Others	03WS	388	C03
01	Exit Only	Blank Escutcheon	01DN	N/A	N/A
02	Pull When Dogged	Dummy Lever	02DN	360LxDT	2902A
08	Key Unlocks & Locks Lever	Classroom Lever	08DN	360L	2908A
09	Lever Active by Key: Locked when key removed	Night Latch / Storeroom Lever	09DN	360L-NL	2903A
14	Lever always active	Passage Lever	14DN	360L-BE	2914A
EU	Electric Lock/Unlock	Fail Secure or Fail Safe	EU2W	E360L-BE	N/A

BHMA Function	BHMA Definition	Description	SVR Narrow Stile 50/51 Series	SVR Narrow Stile 3527A Series	Narrow Stile SVR Not Available
01	Exit Only	Cover Plate	01CN	N/A	N/A
02	Pull When Dogged	Dummy Pull	02CN	386DT	N/A
03	Key Retracts Latch Bolt	Night Latch Pull	03CN	386NL	N/A
03	Key Retracts Latch Bolt	Night Latch - Cylinder Only - Pull by Others	03WS	388	N/A
01	Exit Only	Blank Escutcheon	01DN	N/A	N/A
02	Pull When Dogged	Dummy Lever	02DN	360LxDT	N/A
08	Key Unlocks & Locks Lever	Classroom Lever	08DN	360L	N/A
09	Lever Active by Key: Locked when key removed	Night Latch / Storeroom Lever	09DN	360LxNL	N/A
14	Lever always active	Passage Lever	14DN	360L-BE	N/A
EU	Electric Lock/Unlock	Fail Secure or Fail Safe	EU2W	E360L-BE	N/A

BHMA Function	BHMA Definition	Description	CVR Narrow Stile 60/61 Series for Aluminum Doors	CVR Narrow Stile 3547A Series	CVR Narrow Stile 2600 Series
02	Pull When Dogged	Dummy Pull (Wire)	02WP	8190	N/A
03	Key Retracts Latch Bolt	Night Latch - Cylinder Only - Pull by Others	03R	388	N/A
01	Exit Only	Blank Escutcheon	01DNV	N/A	N/A
02	Pull When Dogged	Dummy Lever	02DNV	360LxDT	2902A
08	Key Unlocks & Locks Lever	Classroom Lever	08DNV	360L	2908A
09	Lever Active by Key: Locked when key removed	Night Latch / Storeroom Lever	09DNV	360LxNL	2903A
14	Lever always active	Passage Lever	14DNV	360L-BE	2914A

BHMA Function	BHMA Definition	Description	CVR Narrow Stile 62/63 Series for Hollow Metal Doors	CVR Narrow Stile 3547A Series	CVR Narrow Stile 2600 Series
01	Exit Only	Cover Plate	01CNV	N/A	N/A
02	Pull When Dogged	Dummy Pull	02CNV	N/A	N/A
02	Pull When Dogged	Dummy Pull (Wire)	02WP	8190	N/A
03	Key Retracts Latch Bolt	Night Latch Pull	03CNV	388x8190	N/A
03	Key Retracts Latch Bolt	Night Latch - Cylinder Only - Pull by Others	03R	388	N/A
01	Exit Only	Blank Escutcheon	01DNV	N/A	N/A
02	Pull When Dogged	Dummy Lever	02DNV	N/A	N/A
08	Key Unlocks & Locks Lever	Classroom Lever	08DNV	360L	2908A
09	Lever Active by Key: Locked when key removed	Night Latch / Storeroom Lever	09DNV	360L-NL	2909A
14	Lever always active	Passage Lever	14DNV	360L-BE	2914A

Note: Detex Trims can be ordered separately from Detex Exit Devices

TRIM CROSS REFERENCE CONT'D ON PAGE 34

Where Trust is Built™



ADVANTEX[®] TRIM CROSS REFERENCE MATRIX CONT'D

BHMA Function	BHMA Definition	Description	ADVANTEX [®]	Manufacturer #A Exit Devices	Manufacturer #B Exit Devices
			CVR 70/71 Series for Wood Doors	CVR for Wood Doors 9847 WDC	CVR for Wood Doors 2700
01	Exit Only	Cover Plate	01CV	990EO	1701
02	Pull When Dogged	Dummy Pull	02CV	990DT	1702A
02	Pull When Dogged	Dummy Pull (Wire)	02WP	8190	N/A
03	Key Retracts Latch Bolt	Night Latch Pull	03CV	990NL-R/V	1703A
03	Key Retracts Latch Bolt	Night Latch - Cylinder Only - Pull by Others	03WSV	110NL-MD	N/A
01	Exit Only	Blank Escutcheon	01DV	N/A	N/A
02	Pull When Dogged	Dummy Lever	02DV	996L-DT-CV	4902A
08	Key Unlocks & Locks Lever	Classroom Lever	08DV	996L-CV	4908A
09	Lever Active by Key: Locked when key removed	Night Latch / Storeroom Lever	09DV	996L-NL-CV	4903A
14	Lever always active	Passage Lever	14DV	996LxBE	4914A
EU	Electric Lock/Unlock	Fail Secure or Fail Safe	EUV	E996L	E2703/4908A

BHMA Function	BHMA Definition	Description	CVR 80/81 Series for Hollow Metal Doors	CVR for Hollow Metal Doors 9847	CVR for Hollow Metal Doors 2800
			CVR 80/81 Series for Hollow Metal Doors	CVR for Hollow Metal Doors 9847	CVR for Hollow Metal Doors 2800
01	Exit Only	Cover Plate	01CV	990EO	1701
02	Pull When Dogged	Dummy Pull	02CV	990DT	C1702A
02	Pull When Dogged	Dummy Pull (Wire)	02WP	8190	N/A
03	Key Retracts Latch Bolt	Night Latch Pull	03CV	990NL-RV	C1703A
03	Key Retracts Latch Bolt	Night Latch - Cylinder Only - Pull by Others	03WSV	110NL-MD	N/A
01	Exit Only	Blank Escutcheon	01DV	N/A	N/A
02	Pull When Dogged	Dummy Lever	02DV	996L-DT-CV	4902A
08	Key Unlocks & Locks Lever	Classroom Lever	08DV	996L-L-CV	4908A
09	Lever Active by Key: Locked when key removed	Night Latch / Storeroom Lever	09DV	996L-NL-CV	4903A
14	Lever always active	Passage Lever	14DV	996LxBE	4914A
EU	Electric Lock/Unlock	Fail Secure or Fail Safe	EUV	E996L	E2803/4908A

BHMA Function	BHMA Definition	Description	CVR 82/83 Series for Aluminum Doors	CVR for Aluminum Doors 9847	CVR for Aluminum Doors 2800
			CVR 82/83 Series for Aluminum Doors	CVR for Aluminum Doors 9847	CVR for Aluminum Doors 2800
01	Exit Only	Cover Plate	01CV	990EO	1701
02	Pull When Dogged	Dummy Pull	02CV	990DT	C1702A
02	Pull When Dogged	Dummy Pull (Wire)	02WP	8190	N/A
03	Key Retracts Latch Bolt	Night Latch Pull	03CV	990NL-RV	C1703A
03	Key Retracts Latch Bolt	Night Latch - Cylinder Only - Pull by Others	03WSV	110NL-MD	N/A
01	Exit Only	Blank Escutcheon	01DV	N/A	N/A
02	Pull When Dogged	Dummy Lever	02DV	996L-DT-CV	4902A
08	Key Unlocks & Locks Lever	Classroom Lever	08DV	996L-L-CV	4908A
09	Lever Active by Key: Locked when key removed	Night Latch / Storeroom Lever	09DV	996L-NL-CV	4903A
14	Lever always active	Passage Lever	14DV	996LxBE	4914A
EU	Electric Lock/Unlock	Fail Secure or Fail Safe	EUV	E996L	E2803/4908A

Note: Detex Trims can be ordered separately from Detex Exit Devices

NOTES

Exit Alarm (EA) - Available on all Devices	Price
---	--------------

Standard Package Includes:	Add \$420.00
- Switch monitors pushpad	
- Green & Red LED, cylinder arming, 9 Volt battery and piezo horn	
- Cylinder Dogging (CD) standard except for "F" (Fire Rated) device	
- Self-adhesive Door Sign (EA-561 English - Red)	

EA Options

FC - Flex Conduit and Endcap (Example EAxFC)	
KS - Key Stop Feature Installed	Add \$35.00
LD - Less Dogging	Add \$5.00
Substitute Door Signage Available (See Accessories - Page 48)	N/C
LX - Latchbolt Signalling Switch (example EAxLX)	N/C
	Add \$196.00

EA Accessories

(NOTE: EA alarm can be hardwired with 12V AC/DC through 24V AC/DC)

PP-5152-2 Transformer 24VAC	\$69.00
PP-5152-3 Transformer 12VAC	\$32.00
PT-5 - Power Transfer	Add \$134.00
EWH8-626 - Electric Hinge	Add \$329.00

Weatherized Exit Alarm (EBxW) - Battery Powered - Available on 10/20/21/40/50/51 Devices	Price
---	--------------

Standard Package Includes:	Add \$600.00
- Remote signaling, remote bypass, pushpad monitoring	
- Green & Red LED, cylinder arming, 9 Volt battery and piezo horn	
- Cylinder Dogging (CD) standard except for "F" (Fire Rated) device	
- Pushpad Signage "Push to Open Alarm Will Sound"	

EBxW Options

FC - Flex Conduit and Endcap (Example EBxWxFC)	Add \$35.00
KS - Key Stop Option Installed at Factory	Add \$5.00
LD - Less Dogging	N/C

EBxW Accessories

BE-961-1 - Battery Eliminator 9VDC Power Source	\$259.00
---	----------

Electric Dogging (ED) - Available on all Devices	Price
---	--------------

Standard Package Includes:	Add \$420.00
- On-board switching requires initial manual pushpad depression after electric activation	
- Long-term dogging	

(Note: A 24V power supply or logic controller is required for ED but not included.)
(Note: Most applications with ED require a power switch. - See pages 114-115)

ED Options

FC - Flex Conduit and Endcap (example EDxFC)	Add \$35.00
EX - Request to Exit Switching (example EDxEX)	Add \$182.00
LX - Latchbolt Signalling Switch (example EDxLX)	Add \$196.00

ED Accessories

CS462 Keyswitch (For other keyswitch and push button options, see pages 114-115)	\$176.00
PP-5152-2 24VAC transformer (Order Separately)	\$69.00
90-800 power supply for filtered, regulated power and simplified fire loop connections - (Order Separately)	See Page 68
PT-5 - Power Transfer	Add \$134.00
EWH8-626 - Electric Hinge	Add \$329.00

Electric Latch Retraction (ER) - Available on all Devices 30" or longer	Price
Standard Package Includes	Add \$899.00
- Simultaneous latch and pushpad retraction	
- Quiet latch retraction	
- Long term dogging capability	
(Note: A Power Supply Controller is required for ER but not included in standard package)	
ER Options	
FC - Flex Conduit and Endcap (example ERxFC)	Add \$35.00
EX - Request to Exit Switching (example ERxEX)	Add \$182.00
LX - Latchbolt Signalling Switch (example ERxLX)	Add \$196.00
Required ER Accessories	
81-800 Power Supply Controller For Latch Retraction - Single Door	See page 68
82-800 Power Supply Controller For Latch Retraction - Pair of Doors Simultaneous	See page 68
83-800 Power Supply Controller For Latch Retraction - Pair of Doors Independent	See page 68
Optional ER Accessories	
PT-5 - Power Transfer	Add \$134.00
EWH8-626 - Electric Hinge	Add \$329.00

Weatherized Electric Latch Retraction (ERxW) - Available on 10/20/21/40/50/51 Devices	Price
Standard Package Includes:	Add \$1,449.00
- Weatherized simultaneous latch and pushpad retraction	
- Long term dogging capability	
- Switches to monitor pushpad, latch bolt and outside trim input	
(Note: A Power Supply is required for ER but not included in standard package. If mounting outside, use NEMA enclosure - See page 117)	
Required ERxW Accessories	
81-800 Power Supply Controller For Latch Retraction - Single Door	See page 68
82-800 Power Supply Controller For Latch Retraction - Pair of Doors Simultaneous	See page 68
83-800 Power Supply Controller For Latch Retraction - Pair of Doors Independent	See page 68
Optional ERxW Accessories	
PT-5 - Power Transfer	Add \$134.00
EWH8-626 - Electric Hinge	Add \$329.00
EX - Request to Exit Switching (example ERxEX)	Add \$182.00
NEMA Enclosure	Add \$1,799.00

Electric Lock/Unlock (EU) Lever Option - Available on 10/20/21/30/70/80 Devices	Price
See Advantex Trim Page 17 for complete information	Add \$938.00

Electric Lock/Unlock (EU2W) Lever Option - Contact factory for use on medium and wide stile doors	Price
See Advantex Trim Page 21 for complete information	Add \$938.00

ELECTRIFIED OPTIONS CONT'D ON PAGE 38

Delayed Egress (EE) - Available on all Devices 36" or longer	Price
Standard Package Includes:	Add \$1,575.00
- 15 second Delayed Egress - alarm switches monitor dead latch	
- 15 second arming delay (AD) with extended bypass (alarm arms after door closes)	
- 1 second nuisance delay	
- Comes standard with 24V Filtered and Regulated Power Supply with simplified fire loop connections	
(NOTE: Detex Power Supply required and included with Standard EE package, can power devices for a pair of doors, specify V40xEExPSO for second door)	
- Switches monitor pushpad, latch bolt and outside trim input	
- Cylinder Dogging (CD) standard except for "F" (Fire Rated) Device	
- Comes with one green LED, one red LED & 100 decibel alarm, field selectable LED status indicator & self-adhesive, code compliant door sign (ECL-395 English - 15 Second - Red)	
For non-standard arming delay, non-standard nuisance delay, non-extended bypass, set grant times and other non-standard options or features, contact factory.	
EE Options	
30 - 30 Second Delayed Egress (example EEx30) (NOTE: Requires pre-approved letter from AHJ)	N/C
FC - Flex Conduit and Endcap (example EExFC)	Add \$35.00
KS - Key Stop feature installed	Add \$5.00
LD - Less Dogging	N/C
LX - Latchbolt Signalling Switch (example EExLX)	Add \$196.00
EE Accessories	
PT-5 - Power Transfer	Add \$134.00
EWH8-626 - Electric Hinge	Add \$329.00

Delayed Egress with Latch Retraction (EExER) - Available on all Devices 36" or longer	Price
Standard Package Includes:	Add \$2,295.00
- Switches to monitor pushpad and dead latch	
- Quiet latch retraction	
- Sold separately, but required and Included as part of Power Supply Controller is the Remote, wall mount keyswitch & horn, with green and red LED, 100 dB alarm (RIU) as part of 84-800 and 85-800	
(NOTE: A Logic Controller is required for EExER but not included in standard package)	
For options such as Silent Arming, arming times, set grant times, Key Stop (armed when key removed) Rearm using Key Only, access control only bypasses (RKO) and other options, see power supply controllers on pages 68-69.	
EExER Options	
ULC - Underwriters Laboratories Canadian Listing	Add \$294.00
30 - 30 Second Delayed Egress (example EExERx30) (NOTE: Requires pre-approved letter from AHJ)	N/C
FC - Flex Conduit and Endcap (Example EExERxFC)	Add \$35.00
KS - Key Stop feature installed	Add \$5.00
Substitute Door Signage Available (See Accessories - Page 48)	N/C
LX - Latchbolt Signalling Switch (example EExERxLX)	Add \$196.00
Required EExER Accessories	
84-800 Power Supply Controller for single doors - for options such as Silent Arming / no chirps (SA), Reset with Key Only, access control does not reset alarm, just bypass (RKO), contact factory – includes wall mount key switch & Horn interface box (RIU)	See page 69
85-800 Power Supply Controller for pairs of doors - for options such as Silent Arming / no chirps (SA), Reset with Key Only, access control does not reset alarm, just bypass (RKO), contact factory – includes wall mount key switch & Horn interface box (RIU)	See page 69
Optional EExER Accessories	
PT-5 - Power Transfer	Add \$134.00
EWH8-626 - Electric Hinge	Add \$329.00

ELECTRIFIED OPTIONS CONT'D ON PAGE 39

Delayed Egress with Magnetic Lock (EM) - Available on 10/40 Devices	Price
Standard Package Includes	Add \$1,700.00
- 15 second Delayed Egress with dead latch monitoring	
- 24V Filtered and Regulated Power Supply with simplified fire loop connections.	
(NOTE: Detex Power Supply required and included with Standard EM package)	
- Cylinder Dogging (CD) standard except for "F" (Fire Rated) device	
- Magnetic Lock	
- Self-adhesive, Code Compliant Door Sign (ECL-395 English - 15 Second - Red)	
EM Options	
30 - 30 Second Delayed Egress (example EMx30) (NOTE: Requires pre-approved letter from AHJ)	N/C
FC - Flex Conduit and Endcap (example EMxFC)	Add \$35.00
KS - Key Stop Feature Installed	Add \$5.00
LD - Less Dogging	N/C
Substitute Door Signage Available (See Accessories - Page 48)	N/C
EM Accessories	
PT-5 - Power Transfer	Add \$134.00
EWH8-626 - Electric Hinge	Add \$329.00

Electric Switching (ES) - Available on 10/40 Devices	Price
Standard Package Includes:	Add \$265.00
- Switches to monitor dead latch and outside trim input	
- Hex Dogging (HD) standard except for Fire Rated device	
ES Options	
FC - Flex Conduit and Endcap (example ESxFC)	Add \$35.00
CD - Cylinder Dogging	N/C
LD - Less Dogging	N/C
ES Accessories	
PT-5 - Power Transfer	Add \$134.00
EWH8-626 - Electric Hinge	Add \$329.00

Latch Bolt Signaling (LX) - Available on 10/40/60/61/62/63/70/71/80/81/82/83 Devices	Price
Standard Package Includes:	Add \$196.00
- Switch monitors latchbolt	
- Hex Dogging (HD) standard except for "F" (Fire Rated) device	
LX Options	
FC - Flex Conduit and Endcap (example EXVxFC)	Add \$35.00
CD - Cylinder Dogging	N/C
LD - Less Dogging	N/C
LX Accessories	
PT-5 - Power Transfer	Add \$134.00
EWH8-626 - Electric Hinge	Add \$329.00
MS-1039S/1059S - Magnetic Switch (Surface)	Add \$48.00
MS-1039F/1059F - Magnetic Switch (Flush)	Add \$27.00

ELECTRIFIED OPTIONS CONT'D ON PAGE 40

Where Trust is Built™

Electric Integration (EI) - Available on 10/30/40 Devices	Price
Standard Package Includes:	Add \$310.00
- Switches to monitor dead latch and outside trim input	
- Green and Red LED, cylinder arming and piezo horn (logic & power supply separate)	
- Cylinder Dogging (CD) standard except for "F" (Fire Rated) device	
- Code Compliant Signage (EA-561 English Red)	
(Note: A Logic Controller is required for EI but not included in standard package)	
<u>EI Options</u>	
FC - Flex Conduit and Endcap (Example EIxFC)	Add \$35.00
KS - Key Stop Feature Installed	Add \$5.00
LD - Less Dogging	N/C
<u>EI Accessories</u>	
10-800 or 11-800 - Logic Controller for Electric Integration	See Page 70
PT-5 - Power Transfer	Add \$134.00
EWH8-626 - Electric Hinge	Add \$329.00

Request to Exit Signaling (EX) - Available on all Devices	Price
Standard Package Includes:	Add \$182.00
- Switch monitors pushpad	
- Hex Dogging (HD) standard except for "F" (Fire Rated) device	
<u>EX Options</u>	
FC - Flex Conduit and Endcap (example EXxFC)	Add \$35.00
CD - Cylinder Dogging	N/C
LD - Less Dogging	N/C
LX - Latchbolt Signalling Switch (example EXxLX)	Add \$196.00
<u>EX Accessories</u>	
PT-5 - Power Transfer	Add \$134.00
EWH8-626 - Electric Hinge	Add \$329.00

Weatherized Request to Exit Signaling (EXxW) - Available on 10/20/21/30/40/50/51/01/04 Devices	Price
Standard Package Includes:	Add \$209.00
- Weatherized switch monitors pushpad	
- Hex Dogging (HD) standard except for "F" (Fire Rated) device	
<u>EXxW Options</u>	
FC - Flex Conduit and Endcap (example EXxWxFC)	Add \$35.00
CD - Cylinder Dogging	N/C
LD - Less Dogging	N/C
<u>EXxW Accessories</u>	
PT-5 - Power Transfer	Add \$134.00
EWH8-626 - Electric Hinge	Add \$329.00

ELECTRIFIED OPTIONS CONT'D ON PAGE 41

Request to Exit Switching for High Current (EXV) - Available on All Devices	Price
Standard Package Includes:	Add \$310.00
- 3 AMP Switch monitors pushpad	
- Hex Dogging (HD) standard except for "F" (Fire Rated) device	
<u>EXV Accessories</u>	
FC - Flex Conduit and Endcap (example EXVxFC)	Add \$35.00
CD - Cylinder Dogging	N/C
LD - Less Dogging	N/C
LX - Latchbolt Signalling Switch (example EXVxLX)	Add \$196.00
2 - Includes 2 High Current Switches (EXV2)	Add \$300.00
<u>EXV Options</u>	
PT-5 - Power Transfer	Add \$134.00
EWH8-626 - Electric Hinge	Add \$329.00
<u>Latch Bolt Signaling for High Current (LXV) - Available on 10/40 Devices</u>	
Standard Package Includes:	Add \$330.00
- 3 AMP switch monitors latchbolt	
- Hex Dogging (HD) standard except for "F" (Fire Rated) device	
<u>LXV Options</u>	
FC - Flex Conduit and Endcap (example EXVxFC)	Add \$35.00
CD - Cylinder Dogging	N/C
LD - Less Dogging	N/C
<u>LXV Accessories</u>	
PT-5 - Power Transfer	Add \$134.00
EWH8-626 - Electric Hinge	Add \$329.00
MS-1039S/1059S - Magnetic Switch (Surface)	Add \$48.00
MS-1039F/1059F - Magnetic Switch (Flush)	Add \$27.00
<u>Weatherized Request to Exit Switching for High Current (EXVxW) - Available on 10/20/21/30/40/50/51/01/04 Devices</u>	
Standard Package Includes:	Add \$350.00
- 3 AMP Weatherized switch monitors pushpad	
- Hex Dogging (HD) standard except for "F" (Fire Rated) device	
<u>EXVxW Options</u>	
FC - Flex Conduit and Endcap (example EXVxWxFC)	Add \$35.00
CD - Cylinder Dogging	N/C
LD - Less Dogging	N/C
<u>EXVxW Accessories</u>	
PT-5 - Power Transfer	Add \$134.00
EWH8-626 - Electric Hinge	Add \$329.00



EASY PRICE REFERENCE CHART CONT'D

Model	630																
	Base Price	EA	EBXW	ED	ER	ERXW	EE	EEER	EM	EI	ES	LY	EX	EXXW	EXV	LXV	EXXW
		\$420	\$600	\$420	\$899	\$1,449	\$1,575	\$2,295	\$1,700	\$310	\$260	\$196	\$182	\$209	\$310	\$330	\$350
50/51 Series Narrow Surface Vertical Rod (device only)	\$1,891	2,311	N/A	2,311	2,790	3,340	3,466	4,186	N/A	N/A	N/A	N/A	2,073	2,100	2,201	N/A	2,241
5001 CN (exit only cover plate)	\$2,044	2,464	N/A	2,464	2,943	3,493	3,619	4,339	N/A	N/A	N/A	N/A	2,226	2,253	2,354	N/A	2,394
5001 DN (blank escutcheon)	\$2,303	2,723	N/A	2,723	3,202	3,752	3,878	4,598	N/A	N/A	N/A	N/A	2,485	2,512	2,613	N/A	2,653
5002 CN (dummy pull)	\$2,110	2,530	N/A	2,530	3,009	3,559	3,685	4,405	N/A	N/A	N/A	N/A	2,292	2,319	2,420	N/A	2,460
5002 DN (dummy lever*)	\$2,303	2,723	N/A	2,723	3,202	3,752	3,878	4,598	N/A	N/A	N/A	N/A	2,485	2,512	2,613	N/A	2,653
5003 WS (key retracts latch)	\$2,036	2,456	N/A	2,456	2,935	3,485	3,611	4,331	N/A	N/A	N/A	N/A	2,218	2,245	2,346	N/A	2,386
5003 CN (key retracts latch pull)	\$2,139	2,559	N/A	2,559	3,038	3,588	3,714	4,434	N/A	N/A	N/A	N/A	2,321	2,348	2,449	N/A	2,489
5008 DN (lever trim*)	\$2,343	2,763	N/A	2,763	3,242	3,792	3,918	4,638	N/A	N/A	N/A	N/A	2,525	2,552	2,653	N/A	2,693
5009 DN (lever trim* - locked when key removed)	\$2,343	2,763	N/A	2,763	3,242	3,792	3,918	4,638	N/A	N/A	N/A	N/A	2,525	2,552	2,653	N/A	2,693
5014 DN (lever trim* passage)	\$2,343	2,763	N/A	2,763	3,242	3,792	3,918	4,638	N/A	N/A	N/A	N/A	2,525	2,552	2,653	N/A	2,693
50EU2W (electric lock/unlock)	\$2,829	3,249	N/A	3,249	3,728	4,278	4,404	5,124	N/A	N/A	N/A	N/A	3,011	3,038	3,139	N/A	3,179
60/61 Series Narrow Concealed Vertical Rod for Aluminum Doors (device)	\$2,006	2,426	N/A	2,426	2,905	N/A	3,581	4,301	N/A	N/A	N/A	2,202	2,188	N/A	2,316	N/A	N/A
6002 WP (dummy pull)	\$2,205	2,625	N/A	2,625	3,104	N/A	3,780	4,500	N/A	N/A	N/A	2,401	2,387	N/A	2,515	N/A	N/A
6002 DNV (dummy lever*)	\$2,492	2,912	N/A	2,912	3,391	N/A	4,067	4,787	N/A	N/A	N/A	2,688	2,674	N/A	2,802	N/A	N/A
6003 R (key retracts latch)	\$2,302	2,722	N/A	2,722	3,201	N/A	3,877	4,597	N/A	N/A	N/A	2,498	2,484	N/A	2,612	N/A	N/A
6008 DNV (lever trim*)	\$2,539	2,959	N/A	2,959	3,438	N/A	4,114	4,834	N/A	N/A	N/A	2,735	2,721	N/A	2,849	N/A	N/A
6009 DNV (lever trim* - locked when key removed)	\$2,539	2,959	N/A	2,959	3,438	N/A	4,114	4,834	N/A	N/A	N/A	2,735	2,721	N/A	2,849	N/A	N/A
6014 DNV (lever trim* passage)	\$2,539	2,959	N/A	2,959	3,438	N/A	4,114	4,834	N/A	N/A	N/A	2,735	2,721	N/A	2,849	N/A	N/A
62/63 Series Narrow Concealed Vertical Rod for Hollow Metal Doors	\$2,006	2,426	N/A	2,426	2,905	N/A	3,581	4,301	N/A	N/A	N/A	2,202	2,188	N/A	2,316	N/A	N/A
6201 CNV (exit only cover plate)	\$2,187	2,607	N/A	2,607	3,086	N/A	3,762	4,482	N/A	N/A	N/A	2,383	2,369	N/A	2,497	N/A	N/A
6202 CNV (dummy pull)	\$2,265	2,685	N/A	2,685	3,164	N/A	3,840	4,560	N/A	N/A	N/A	2,461	2,447	N/A	2,575	N/A	N/A
6202 WP (dummy pull)	\$2,205	2,625	N/A	2,625	3,104	N/A	3,780	4,500	N/A	N/A	N/A	2,401	2,387	N/A	2,515	N/A	N/A
6202 DNV (dummy lever*)	\$2,492	2,912	N/A	2,912	3,391	N/A	4,067	4,787	N/A	N/A	N/A	2,688	2,674	N/A	2,802	N/A	N/A
6203 R (key retracts latch)	\$2,302	2,722	N/A	2,722	3,201	N/A	3,877	4,597	N/A	N/A	N/A	2,498	2,484	N/A	2,612	N/A	N/A
6203 CNV (key retracts latch pull)	\$2,298	2,718	N/A	2,718	3,197	N/A	3,873	4,593	N/A	N/A	N/A	2,494	2,480	N/A	2,608	N/A	N/A
6208 DNV (lever trim*)	\$2,539	2,959	N/A	2,959	3,438	N/A	4,114	4,834	N/A	N/A	N/A	2,735	2,721	N/A	2,849	N/A	N/A
6209 DNV (lever trim* - locked when key removed)	\$2,539	2,959	N/A	2,959	3,438	N/A	4,114	4,834	N/A	N/A	N/A	2,735	2,721	N/A	2,849	N/A	N/A
6214 DNV (lever trim* passage)	\$2,539	2,959	N/A	2,959	3,438	N/A	4,114	4,834	N/A	N/A	N/A	2,735	2,721	N/A	2,849	N/A	N/A
70/71 Series Concealed Vertical Rod for Wood Doors (device only)	\$2,029	2,449	N/A	2,449	2,928	N/A	3,604	4,324	N/A	N/A	N/A	2,225	2,211	N/A	2,339	N/A	N/A
7001 CV (exit only cover plate)	\$2,203	2,623	N/A	2,623	3,102	N/A	3,778	4,498	N/A	N/A	N/A	2,399	2,385	N/A	2,513	N/A	N/A
7002 CV (dummy pull)	\$2,279	2,699	N/A	2,699	3,178	N/A	3,854	4,574	N/A	N/A	N/A	2,475	2,461	N/A	2,589	N/A	N/A
7002 WP (dummy pull)	\$2,228	2,648	N/A	2,648	3,127	N/A	3,803	4,523	N/A	N/A	N/A	2,424	2,410	N/A	2,538	N/A	N/A
7002 DV (dummy lever*)	\$2,473	2,893	N/A	2,893	3,372	N/A	4,048	4,768	N/A	N/A	N/A	2,669	2,655	N/A	2,783	N/A	N/A
7003 WSV (key retracts latch)	\$2,199	2,619	N/A	2,619	3,098	N/A	3,774	4,494	N/A	N/A	N/A	2,395	2,381	N/A	2,509	N/A	N/A
7003 CV (key retracts latch pull)	\$2,311	2,731	N/A	2,731	3,210	N/A	3,886	4,606	N/A	N/A	N/A	2,507	2,493	N/A	2,621	N/A	N/A
7008 DV (lever trim*)	\$2,515	2,935	N/A	2,935	3,414	N/A	4,090	4,810	N/A	N/A	N/A	2,711	2,697	N/A	2,825	N/A	N/A
7009 DV (lever trim* - locked when key removed)	\$2,515	2,935	N/A	2,935	3,414	N/A	4,090	4,810	N/A	N/A	N/A	2,711	2,697	N/A	2,825	N/A	N/A
7014 DV (lever trim* passage)	\$2,515	2,935	N/A	2,935	3,414	N/A	4,090	4,810	N/A	N/A	N/A	2,711	2,697	N/A	2,825	N/A	N/A
70 EUV (electric lock/unlock)	\$3,098	3,518	N/A	3,518	3,997	N/A	4,673	5,393	N/A	N/A	N/A	3,294	3,280	N/A	3,408	N/A	N/A

*lever design specify S, T, or U

EASY PRICE REFERENCE CHART CONT'D ON PAGE 44

Where Trust is Built™





EASY PRICE REFERENCE CHART CONT'D

Model	630 Base Price	EA	EBxW	ED	ER	ERxW	EE	EExER	EM	EI	ES	Lx	Ex	ExxW	ExV	LxV	ExVxW
		\$420	\$600	\$420	\$899	\$1,449	\$1,575	\$2,295	\$1,700	\$310	\$265	\$196	\$182	\$209	\$310	\$330	\$350
80/81 Series Concealed Vertical Rod for Hollow Metal Doors (device only)	\$2,029	2,449	2,629	2,449	2,928	3,478	3,604	4,324	N/A	N/A	N/A	2,225	2,211	N/A	2,339	N/A	N/A
8001 CV (exit only cover plate)	\$2,203	2,623	2,803	2,623	3,102	3,652	3,778	4,498	N/A	N/A	N/A	2,399	2,385	N/A	2,513	N/A	N/A
8002 CV (dummy pull)	\$2,279	2,699	2,879	2,699	3,178	3,728	3,854	4,574	N/A	N/A	N/A	2,475	2,461	N/A	2,589	N/A	N/A
8002 WP (dummy pull)	\$2,224	2,644	2,824	2,644	3,123	3,673	3,799	4,519	N/A	N/A	N/A	2,420	2,406	N/A	2,534	N/A	N/A
8002 DV (dummy lever*)	\$2,473	2,893	3,073	2,893	3,372	3,922	4,048	4,768	N/A	N/A	N/A	2,669	2,655	N/A	2,783	N/A	N/A
8003 WSV (key retracts latch)	\$2,199	2,619	2,799	2,619	3,098	3,648	3,774	4,494	N/A	N/A	N/A	2,395	2,381	N/A	2,509	N/A	N/A
8003 CV (key retracts latch pull)	\$2,311	2,731	2,911	2,731	3,210	3,760	3,886	4,606	N/A	N/A	N/A	2,507	2,493	N/A	2,621	N/A	N/A
8008 DV (lever trim*)	\$2,515	2,935	3,115	2,935	3,414	3,964	4,090	4,810	N/A	N/A	N/A	2,711	2,697	N/A	2,825	N/A	N/A
8009 DV (lever trim* - locked when key removed)	\$2,515	2,935	3,115	2,935	3,414	3,964	4,090	4,810	N/A	N/A	N/A	2,711	2,697	N/A	2,825	N/A	N/A
8014 DV (lever trim* passage)	\$2,515	2,935	3,115	2,935	3,414	3,964	4,090	4,810	N/A	N/A	N/A	2,711	2,697	N/A	2,825	N/A	N/A
80 EUV (electric lock/unlock)	\$3,098	3,518	3,698	3,518	3,997	4,547	4,673	5,393	N/A	N/A	N/A	3,294	3,280	N/A	3,408	N/A	N/A

82/83 Series Concealed Vertical Rod for Hollow Metal Doors (device only)	\$2,029	2,449	2,629	2,449	2,928	3,478	3,604	4,324	N/A	N/A	N/A	2,225	2,211	N/A	2,339	N/A	N/A
8201 CV (exit only cover plate)	\$2,203	2,623	2,803	2,623	3,102	3,652	3,778	4,498	N/A	N/A	N/A	2,399	2,385	N/A	2,513	N/A	N/A
8202 CV (dummy pull)	\$2,279	2,699	2,879	2,699	3,178	3,728	3,854	4,574	N/A	N/A	N/A	2,475	2,461	N/A	2,589	N/A	N/A
8202 WP (dummy pull)	\$2,224	2,644	2,824	2,644	3,123	3,673	3,799	4,519	N/A	N/A	N/A	2,420	2,406	N/A	2,534	N/A	N/A
8202 DV (dummy lever*)	\$2,473	2,893	3,073	2,893	3,372	3,922	4,048	4,768	N/A	N/A	N/A	2,669	2,655	N/A	2,783	N/A	N/A
8203 WSV (key retracts latch)	\$2,199	2,619	2,799	2,619	3,098	3,648	3,774	4,494	N/A	N/A	N/A	2,395	2,381	N/A	2,509	N/A	N/A
8203 CV (key retracts latch pull)	\$2,311	2,731	2,911	2,731	3,210	3,760	3,886	4,606	N/A	N/A	N/A	2,507	2,493	N/A	2,621	N/A	N/A
8208 DV (lever trim*)	\$2,515	2,935	3,115	2,935	3,414	3,964	4,090	4,810	N/A	N/A	N/A	2,711	2,697	N/A	2,825	N/A	N/A
8209 DV (lever trim* - locked when key removed)	\$2,515	2,935	3,115	2,935	3,414	3,964	4,090	4,810	N/A	N/A	N/A	2,711	2,697	N/A	2,825	N/A	N/A
8214 DV (lever trim* passage)	\$2,515	2,935	3,115	2,935	3,414	3,964	4,090	4,810	N/A	N/A	N/A	2,711	2,697	N/A	2,825	N/A	N/A
82 EUV (electric lock/unlock)	\$3,098	3,518	3,698	3,518	3,997	4,547	4,673	5,393	N/A	N/A	N/A	3,294	3,280	N/A	3,408	N/A	N/A

*lever design specify S, T, or U

Model	630 Base Price	EA	EBxW	ED	ER	ERxW	EE	EExER	EM	EI	ES	Lx	Ex	ExxW	ExV	LxV	ExVxW
		\$420	\$600	\$420	\$899	\$1,449	\$1,575	\$2,295	\$1,700	\$310	\$265	\$196	\$182	\$209	\$310	\$330	\$350
00 Series Dummy Exit Device																	
0000 (wide stile rail)	\$600	N/A	N/A	N/A	N/A	N/A	N/A	N/A	N/A	N/A	N/A	N/A	N/A	N/A	N/A	N/A	N/A
0500xEC2 (narrow stile rail)	\$749	N/A	N/A	N/A	N/A	N/A	N/A	N/A	N/A	N/A	N/A	N/A	N/A	N/A	N/A	N/A	N/A
01 (wide stile with active pushpad)	\$749	N/A	N/A	N/A	N/A	N/A	N/A	N/A	N/A	N/A	N/A	N/A	N/A	N/A	N/A	N/A	N/A
04 (narrow stile with active pushpad)	\$854	N/A	N/A	N/A	N/A	N/A	N/A	N/A	N/A	N/A	N/A	N/A	1,036	1,063	1,164	N/A	1,204
0101C	\$884	N/A	N/A	N/A	N/A	N/A	N/A	N/A	N/A	N/A	N/A	N/A	1,066	1,093	1,194	N/A	1,234
0101W	\$909	N/A	N/A	N/A	N/A	N/A	N/A	N/A	N/A	N/A	N/A	N/A	1,091	1,118	1,219	N/A	1,259
0102C	\$956	N/A	N/A	N/A	N/A	N/A	N/A	N/A	N/A	N/A	N/A	N/A	1,138	1,165	1,266	N/A	1,306
0102D	\$1,147	N/A	N/A	N/A	N/A	N/A	N/A	N/A	N/A	N/A	N/A	N/A	1,329	1,356	1,457	N/A	1,497
0401CN	\$1,007	N/A	N/A	N/A	N/A	N/A	N/A	N/A	N/A	N/A	N/A	N/A	1,189	1,216	1,317	N/A	1,357
0402CN	\$1,067	N/A	N/A	N/A	N/A	N/A	N/A	N/A	N/A	N/A	N/A	N/A	1,249	1,276	1,377	N/A	1,417
0402DN	\$1,252	N/A	N/A	N/A	N/A	N/A	N/A	N/A	N/A	N/A	N/A	N/A	1,434	1,461	1,562	N/A	1,602

NOTES

SIF-EA - Electric Slide-In Filler Kit		Finishes: 628, 630, 693, 695 606, 612, 613 605, 611, 629			
SIF-EA	Exit Alarm 9VDC/12VAC with remote signal and remote bypass	36" Device	\$420.00	\$479.00	\$506.00
		48" Device	\$420.00	\$479.00	\$506.00
Kit Includes: End Cap Bracket with Battery Clip, 9V Battery, Warning Sign (ECL-561)					
NOTE: YOU MUST SPECIFY THE DEVICE SERIES, DOGGING, STILE, STRIKE, SIZE AND FINISH WHEN ORDERING.					
Options					
KS	Key Stop Kit				\$4.00
SIF-HD-CD-LD Slide-In Filler Kits		Finishes: 628, 630, 693, 695 606, 612, 613 605, 611, 629			
SIF-LD-36	Less Dogging Slide-In Filler	36" Device	\$125.00	\$185.00	\$212.00
SIF-LD-48	Less Dogging Slide-In Filler	48" Device	\$125.00	\$185.00	\$212.00
SIF-HD-36	Hex Key Dogging Slide-In Filler	36" Device	\$149.00	\$208.00	\$249.00
SIF-HD-48	Hex Key Dogging Slide-In Filler	48" Device	\$149.00	\$208.00	\$249.00
SIF-CD-36	Cylinder Dogging Slide-In Filler	36" Device	\$149.00	\$208.00	\$249.00
SIF-CD-48	Cylinder Dogging Slide-In Filler	48" Device	\$149.00	\$208.00	\$249.00
NOTE: YOU MUST SPECIFY THE DEVICE SERIES, DOGGING, STILE, STRIKE SIZE, ENDCAP (EC1/EC2) AND FINISH WHEN ORDERING.					
Strikes					Price
90	Non-Handed Curved Lip Strike				\$27.00
91	ANSI Flat Lip Strike				\$27.00
92	Double Door Short Open Back Strike				\$89.00
93	Double Door Long Open Back Strike				\$68.00
94	Double Door Strike Kit with Tamper Resistant and Standard Fasteners (No security driver required)				\$57.00
95T	Top Strike (for 60/61/62/63/70/71/80/81/82/83 Series Devices)				\$72.00
95B	Bottom Strike (for 60/62/70/80/82 Series Devices)				\$33.00
96 Top	Surface Non-Roller Strike (for 50/51 Series Devices)				\$30.00
96B Bottom	Dust Proof Strike (for 50 Series Devices)				\$36.00
97 Top	Surface Non-Roller Strike (for 20/21 Series Devices)				\$30.00
97 Bottom	Dust Proof Strike (for 20 Series Devices)				\$36.00
98	Semi-Mortise Strike (for 10/40 Series Devices)				\$42.00
99	Surface Non-Roller Strike (for 10/40 Series Devices)				\$35.00
SHK1	Strike Hook Kit (1 per package)				\$16.00
Hex Dogging Key					Price
HDK	Hex Dogging Key				\$3.00
Surface Vertical Rod Conversion Kits		Finishes: 630, 693, 695 606, 612, 613 605, 611, 629			
SVRK-8-X	Converts 7 foot rods to 8 foot rods		\$159.00	\$279.00	\$349.00
SVRK-10-X	Converts 7 foot rods to 10 foot rods		\$379.00	\$379.00	\$399.00

PARTS/ACCESSORIES CONT'D ON PAGE 47

Sex Nuts - Security Screws - Security Bits		Price	
SN1	Sex Nut Kit - 1/4"-20 (2 per package)* - Specify Finishes: 606, 613, 626	\$14.00	
SN2	Sex Nut Kit - 10-32 (2 per package)* - Specify Finishes: 606, 613, 630	\$16.00	
SSK1	Torx [®] Security Screw Kit for Rim Exit Device, Stainless Steel only, incl. Torx [®] bits	\$38.00	
SSK2	Torx [®] Security Screw Kit for SVR Exit Device, Stainless Steel only, incl. Torx [®] bits	\$48.00	
TT10	Torx [®] driver tip for 6-32 undercut FH screws	\$8.00	
TT15	Torx [®] driver tip for 6-32 FH screws	\$8.00	
TT25	Torx [®] driver tip for 10-32 FH screws	\$8.00	
TT27	Torx [®] driver tip for 1/4" and #14 screws	\$8.00	
* Devices may require more than 1 Kit - For more information refer to Advantex Technical Information in Catalog			
Electrified Relay Kits		Price	
RLY12	12 VAC Relay Kit - For use with 12V alarms that have remote bypass feature. Used with remote bypass to shunt alarm and activate another electrified device - Separate J-Box required	\$57.00	
RLY24	24 VAC Relay Kit - For use with 24V alarms that have remote bypass feature. Used with remote bypass to shunt alarm and activate another electrified device - Separate J-Box required	\$64.00	
Glass Bead Kits		Price	
GB1	Glass Bead Kit - 10 Series/70 Series/80 Series	\$68.00	
GB2	Glass Bead Kit - 40 Series/60 Series	\$68.00	
GB3	Glass Bead Kit - 20 Series 7 foot height	\$268.00	
GB4	Glass Bead Kit - 21 Series 7 foot height	\$168.00	
GB5	Glass Bead Kit - 50 Series 7 foot height	\$268.00	
GB6	Glass Bead Kit - 51 Series 7 foot height	\$168.00	
GB7	Glass Bead Kit - 20 Series 8 foot height	\$368.00	
GB8	Glass Bead Kit - 21 Series 8 foot height	\$268.00	
GB9	Glass Bead Kit - 50 Series 8 foot height	\$368.00	
GB10	Glass Bead Kit - 51 Series 8 foot height	\$268.00	
GB11	Glass Bead Kit - 20 Series 10 foot height	\$388.00	
GB12	Glass Bead Kit - 21 Series 10 foot height	\$288.00	
GB13	Glass Bead Kit - 50 Series 10 foot height	\$388.00	
GB14	Glass Bead Kit - 51 Series 10 foot height	\$288.00	
GB16	Glass Bead Kit - 30 series	\$68.00	
Cylinders and Accessories		Price	Price (Factory Installed)
MC65	Mortise Cylinder, Schlage "C" Keyway, 1-1/8" 6-pin, Keyed 5-pin - Specify Finish	\$30.00	\$60.00
IC7	7-pin SFIC Mortise Cylinder Housing (Core not included)	\$30.00	\$60.00
RC65	Rim Cylinder, Schlage "C" Keyway, 6-pin, Keyed 5-pin (Also known as ECL-445K) - Specify Finish	\$30.00	\$60.00
CCL	Cylinder Collar, Long 11/16" - Specify Finish	\$30.00	
CCS	Cylinder Collar, Short 7/16" - Specify Finish	\$30.00	
CBK	Cylinder Bracket Kit (for rim cylinder used with other manufacturer's trim)	\$25.00	
CAK	Cylinder Anchor Kit (for use with 60 Series Concealed Vertical Rods)	\$40.00	
SE-2	Shaft Extension Kit for Lever Trims for 2 - 2 1/2" thick door	\$55.00	
SE-25	Shaft Extension Kit for Lever Trims for 2 1/8 - 2 3/4" thick door	\$55.00	
SE-3	Shaft Extension Kit for Lever Trims for 2 5/8 - 3 1/4" thick door	\$88.00	
SE-35	Shaft Extension Kit for Lever Trims for 3 1/8 - 3 3/4" thick door	\$88.00	
SE-4	Shaft Extension Kit for Lever Trims for 3 5/8 - 4 1/4" thick door	\$88.00	
SE-65	Shaft Extension Kit for Lever Trims for 6 - 6 5/8" thick door	\$88.00	
Flex Conduit Kits, Armored Loops and Power Transfers		Price	
FCA-X	Flex Conduit Kit (3') includes conduit, ramped endcap and fittings (X= Specify finish - 605, 606, 611, 612, 613, 629, or 630)	\$155.00	
AL18	Surface Mount Armor Loop - 18" (Aluminum Finish)	\$60.00	
JB1	Junction Box - Flex Conduit Kit (for EM Maglock)	\$150.00	
PT-5	Power Transfer	\$134.00	
EW8-626	Electric Hinge	\$329.00	

PARTS/ACCESSORIES CONT'D ON PAGE 48

Where Trust is Built™

DETEX[®]
Life Safety, Security and Security Assurance

Endcaps		Price
EC1	Ramped Endcap Heavy Duty (Specify Finish) 630 Finish	\$75.00
	All other Finishes (605, 606, 612, 613 or 629)	\$149.00
EC2	Flush Endcap (Specify finish)	\$69.00
EC2FC	Flush Endcap with Flex Conduit Fitting (Specify 693 or 695 Finish)	\$86.00
Through Bolt Mounting Plates		Price
TMP1	Through Bolt Mounting Plate (Top only SVR Kit)	\$30.00
TMP2	Through Bolt Mounting Plate (Top and bottom SVR Kit)	\$50.00
Delayed Egress Peel and Stick Door Signage Chart		Price
PUSH UNTIL ALARM SOUNDS - DOOR CAN BE OPENED IN XX SECONDS		
ECL-395	English - 15 Second - Red (Standard)	\$13.00
ECL-395-1	English - 30 Second - Red	\$13.00
ECL-395-2	French/Canadian - 15 Second - Red	\$13.00
ECL-395-3	French/Canadian - 30 Second - Red	\$13.00
ECL-395-4	Spanish - 15 Second - Red	\$13.00
ECL-395-5	Spanish - 30 Second - Red	\$13.00
ECL-395-6	French - 15 Second - Green	\$13.00
ECL-395-7	French - 30 Second - Green	\$13.00
ECL-395-8	German - 15 Second - Green	\$13.00
ECL-395-9	German - 30 Second - Green	\$13.00
ECL-395-10	Chinese - 15 Second - Red	\$13.00
ECL-395-11	Chinese - 30 Second - Red	\$13.00
ECL-395-12	English European - 15 Second - Red	\$13.00
ECL-395-13	English European - 30 Second - Red	\$13.00
Peel and Stick Door Sign		Price
PUSH TO OPEN - ALARM WILL SOUND		
101802-1	English - Green	\$15.00
101802-2	French - Green	\$15.00
101802-3	German - Green	\$15.00
101802-4	Chinese - Red	\$15.00
101802-5	Spanish - Red	\$15.00
101802-6	French/Canadian - Red	\$15.00
Delayed Egress Outdoor Signage Chart		Price
PUSH UNTIL ALARM SOUNDS - DOOR CAN BE OPENED IN 15/30 SECONDS		
101906	English - 15 Second (Metal Sign - Non Adhesive)	\$75.00
101906-1	English - 30 Second (Metal Sign - Non Adhesive)	\$75.00

PARTS/ACCESSORIES CONT'D ON PAGE 49

MODEL NO.	DESCRIPTION	PRICE
GTPLKIT	Gate Plate Kit - Includes Gate Latch Protector (GTPLGRD), GTSTKBKT (Strike Latch Receiver Bracket), GTPL (Adjustable Gate Plate - Does not come with Lockbox or Mounting Holes)	\$653.50

MODEL NO.	DESCRIPTION	PRICE
GTPL	Adjustable Gate Plate - Fits Single Gates 32" - 52" wide Fits square or round gate frames - Does not come with exit device mounting holes	\$400.00
03GS	Optional 03 function cylinder trim used on gates (Rim Cylinder sold separately)	\$94.00
08GSN	Spacer for Narrow Lever Trim	\$108.00
GTSTKBKT	Strike Latch Receiver Bracket	\$152.00
GTPLGRD	Gate Latch Protector	\$99.00

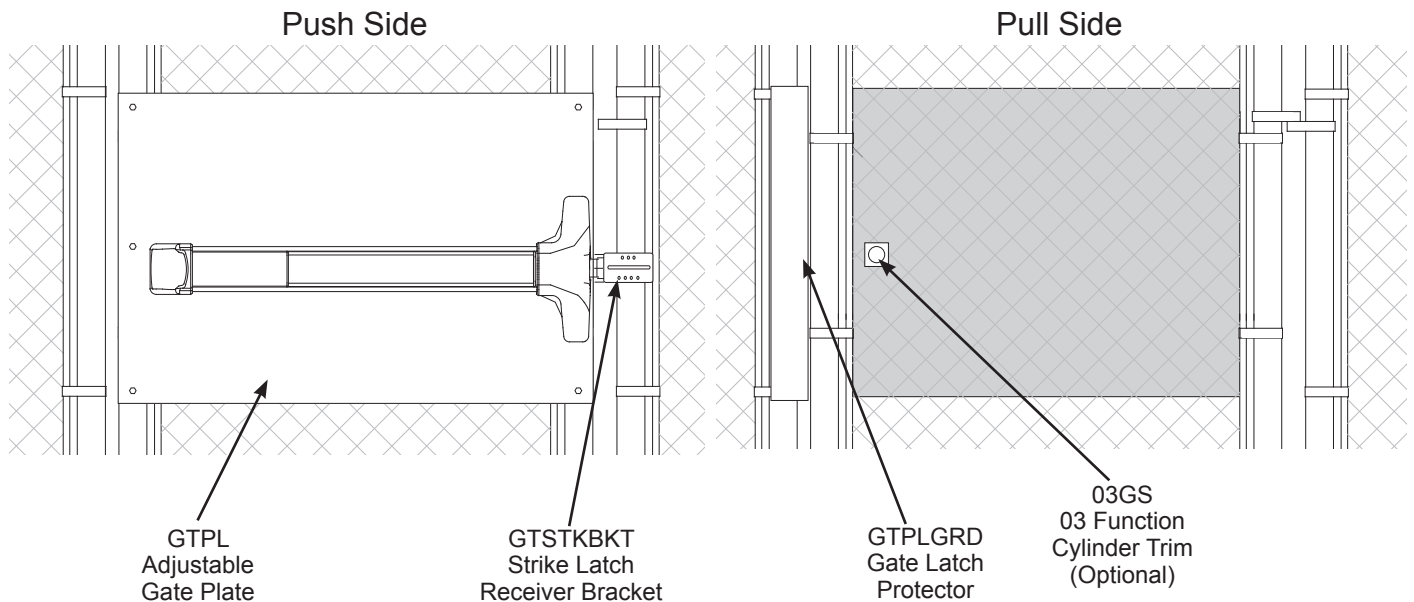

EXIT DEVICE SOLD SEPARATELY

For more information, see Advantex weatherized exit devices

VALUE SERIES®

V40 RIM EXIT DEVICE FOR HOLLOW METAL AND WIDE STILE DOORS

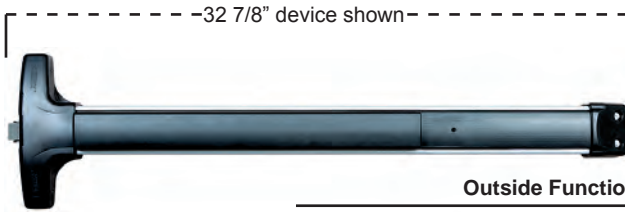

NOTE:
For all trim
information
and graphics
see page 54

Outside Function	Device	Baseplate Finish	
		628 (Std.) Aluminum	711 Black
Device Only - Exit Only No Trim	V40	\$368.00	\$378.00
Device/Function/Trim			
01 Cover Plate	V4001P	\$451.00	\$461.00
	V4001PN	\$451.00	\$461.00
02 Dummy Pull Trim	V4002A	\$456.00	\$466.00
	V4002AN	\$456.00	\$466.00
	V4002WP	\$567.00	N/A
03 Key Retracts Latch pull trim	V4003P	\$451.00	\$461.00
	V4003PN	\$451.00	\$461.00
03 Key Retracts Latch cylinder trim	V4003WS	\$513.00	\$566.00
03 Key Retracts Latch Pull Trim	V4003A	\$456.00	\$466.00
	V4003AN	\$456.00	\$466.00
02 Dummy Lever	V4002D2W	\$780.00	\$827.00
08 Key Locks/Unlocks Outside Lever	V4008BN	\$639.00	\$649.00
	V4008D2W	\$820.00	\$871.00
09 Lever Trim Active by Key; Locked when key removed	V4009BN	\$639.00	\$649.00
	V4009D2W	\$820.00	\$871.00
14 Outside Lever Always Active	V4014BN	\$639.00	\$649.00
	V4014D2W	\$820.00	\$871.00
EU Electric Lock/Unlock	V40EU2W	\$1,306.00	\$1,400.00

Special Note: Specify EU2W trim for Hollow Metal Door, fits doors with minimum 4" (or greater) stile

DEVICE COMES STANDARD WITH:

- 628 Aluminum Baseplate
- HD Hex Dogging
- 36" 36" Device for 3 foot doors
- NS For Narrow Stile Doors see NS option
- 99 Surface Strike



FINISHES

- Aluminum device extrusion is BHMA 628
- Aluminum Trims:
 - P and PN BHMA 628 (clear anodized aluminum)
 - WS BHMA 626 (brushed chrome)
 - A, AN and BN BHMA 689 (powder coated aluminum)
- Black device extrusion is BHMA 711
- Black Trims:
 - P and PN BHMA 711 (black anodized aluminum)
 - WS BHMA 613 (oil rubbed bronze)
 - A, AN and BN BHMA 693 (powder coated black)

OPTIONS

- F Fire Rated - Specify prefix F (ex. FV40) Add \$125.00
- H Hurricane Rated - Specify prefix H (ex. HV40) Add \$100.00
- FH Fire Rated/Hurricane Rated - Specify prefix FH (ex. FHV40) Add \$200.00
- W Weatherized (Mechanical only - For weatherized electrified functions, see Electrified Functions) Add \$79.00
- Electrified Options - see pages 57-61**
- 48" 48" Device for 4'0" doors Add \$31.00
- KS Key Stop Installed Add \$5.00
- CD Cylinder Dogging N/C*
- LD Less Dogging N/C*
- 94 Double Door Strike Available - see pg 64
- 98 Semi-Mortise Strike N/C*



NOTE - Cylinders not included. Products on this page can be ordered with cylinders (C65) or Interchangeable core housings (IC7) pre-installed at Detex prior to shipping (See page 64).



VALUE SERIES®

V40xNS NARROW STILE RIM EXIT DEVICE FOR NARROW STILE DOORS

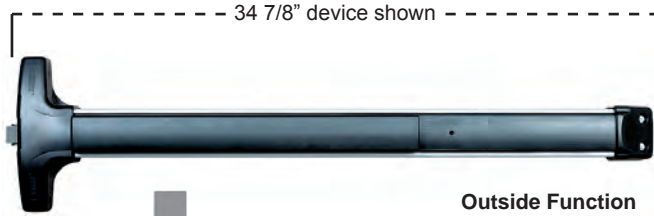

NOTE:
For all trim information and graphics see page 54

Outside Function	Device	Baseplate Finish	
		628 (Std.) Aluminum	711 Black
Device Only - Exit Only No Trim	V40xNS	\$418.00	\$428.00
Device/Function/Trim			
01 Cover Plate	V4001PNxNS	\$501.00	\$511.00
02 Dummy Pull Trim	V4002ANxNS	\$506.00	\$516.00
	V4002WPxNS	\$617.00	N/A
03 Key Retracts Latch pull trim	V4003PNxNS	\$501.00	\$511.00
03 Key Retracts Latch cylinder trim	V4003WSxNS	\$563.00	\$616.00
03 Key Retracts Latch Pull Trim	V4003ANxNS	\$506.00	\$516.00
08 Key Locks/Unlocks Outside Lever	V4008BNxNS	\$689.00	\$699.00
09 Lever Trim Active by Key; Locked when key removed	V4009BNxNS	\$689.00	\$699.00
14 Outside Lever Always Active	V4014BNxNS	\$689.00	\$699.00

Special Note: Specify EU2W trim for Hollow Metal Door, fits doors with minimum 4" (or greater) stile

DEVICE COMES STANDARD WITH:

- 628 Aluminum Baseplate
- HD Hex Dogging
- 36" 36" Device for 3 foot doors
- 98 Semi-Mortise Strike



FINISHES

- Aluminum device extrusion is BHMA 628
- Aluminum Trims:
 - PN BHMA 628 (clear anodized aluminum)
 - WS BHMA 626 (brushed chrome)
 - AN and BN BHMA 689 (powder coated aluminum)
- Black device extrusion is BHMA 711
- Black Trims:
 - PN BHMA 711 (black anodized aluminum)
 - WS BHMA 613 (oil rubbed bronze)
 - AN and BN BHMA 693 (powder coated black)

OPTIONS

F Fire Rated - Specify prefix F (ex. FV40)	Add \$125.00
H Hurricane Rated - Specify prefix H (ex. HV40)	Add \$100.00
FH Fire Rated/Hurricane Rated - Specify prefix FH (ex. FHV40)	Add \$200.00
W Weatherized (Mechanical only - For weatherized electrified functions, see Electrified Functions)	Add \$79.00
Electrified Options - see pages 57-61	
48" 48" Device for 4'0" narrow stile doors	Add \$31.00
KS Key Stop Installed	Add \$5.00
CD Cylinder Dogging	N/C*
LD Less Dogging	N/C*
94 Double Door Strike Available - see pg 64	

NOTE - Cylinders not included. Products on this page can be ordered with cylinders (C65) or Interchangeable core housings (IC7) pre-installed at Detex prior to shipping (See page 64).



V50/V51 SERIES SURFACE VERTICAL ROD EXIT DEVICE

FOR HOLLOW METAL AND WIDE STILE DOORS

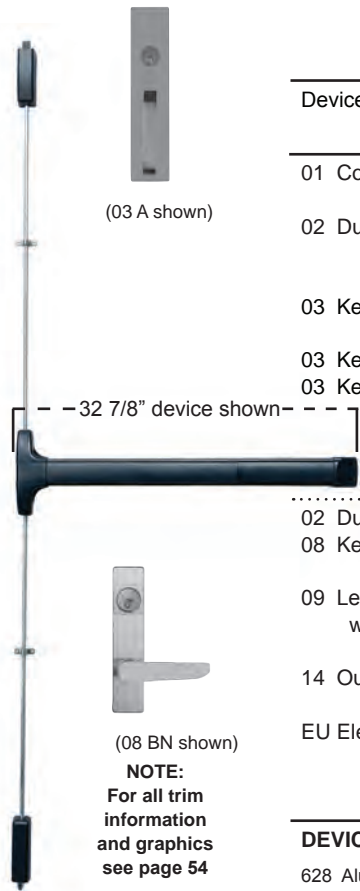

(03 A shown)

— 32 7/8" device shown —



(08 BN shown)

NOTE:
For all trim
information
and graphics
see page 54

Outside Function	Top & Bottom Rod Device	Top Rod Only Device	Baseplate Finish	
			628 (Std.) Aluminum	711 Black
Device Only - Exit Only No Trim	V50	V51	\$729.00	\$739.00
Device/Function/Trim				
01 Cover Plate	V5001P	V5101P	\$812.00	\$822.00
	V5001PN	V5101PN	\$812.00	\$822.00
02 Dummy Pull Trim	V5002A	V5102A	\$817.00	\$827.00
	V5002AN	V5102AN	\$817.00	\$827.00
	V5002WP	V5102WP	\$928.00	N/A
03 Key Retracts Latch Pull trim	V5003P	V5103P	\$812.00	\$822.00
	V5003PN	V5103PN	\$812.00	\$822.00
03 Key Retracts Latch Cylinder trim	V5003WS	V5103WS	\$874.00	\$927.00
03 Key Retracts Latch Pull Trim	V5003A	V5103A	\$817.00	\$827.00
	V5003AN	V5103AN	\$817.00	\$827.00
<hr/>				
02 Dummy Lever	V5002D2W	V5102D2W	\$1,141.00	\$1,188.00
08 Key Locks/Unlocks Outside Lever	V5008BN	V5108BN	\$1,000.00	\$1,010.00
	V5008D2W	V5108D2W	\$1,181.00	\$1,232.00
09 Lever Trim Active by Key; Locked when key removed	V5009BN	V5109BN	\$1,000.00	\$1,010.00
	V5009D2W	V5109D2W	\$1,181.00	\$1,232.00
14 Outside Lever Always Active	V5014BN	V5114BN	\$1,000.00	\$1,010.00
	V5014D2W	V5114D2W	\$1,181.00	\$1,232.00
EU Electric Lock/Unlock	V50EU2W	V51EU2W	\$1,667.00	\$1,761.00

Special Note: Specify EU2W trim for Hollow Metal Door, fits doors with minimum 4" (or greater) stile
Note: Devices are shipped RHR unless specified LHR (Field Reversible)

DEVICE COMES STANDARD WITH:

- 628 Aluminum Baseplate
- HD Hex Dogging
- 36" 36" Device for 3 foot doors
- 84" 84" Rods for 7 foot doors
- 96 Surface Strike



FINISHES

Aluminum device extrusion is BHMA 628
Aluminum Trims:
P and PN BHMA 628 (clear anodized aluminum)
WS BHMA 626 (brushed chrome)
A, AN and BN BHMA 689 (powder coated aluminum)
Black device extrusion is BHMA 711
Black Trims:
P and PN BHMA 711 (black anodized aluminum)
WS BHMA 613 (oil rubbed bronze)
A, AN and BN BHMA 693 (powder coated black)

OPTIONS

F Fire Rated - Specify prefix F (ex. FV50)	Add \$125.00
W Weatherized (Mechanical only - For weatherized electrified functions, see Electrified Functions)	Add \$79.00
RC Rod Covers Stainless Steel Finish - (ex. V50xRC)	Add \$190.00
BG Bottom Bolt Guard 12" ramped per ADA - (ex. V50xBG)	Add \$110.00
RCxBG Rod Covers and Bottom Bolt Guard - (ex. V50xRCxBG)	Add \$300.00
Electrified Options - see pages 57-61	
48" 48" Device for 4'0" doors	Add \$31.00
96" 96" Rods for 8'0" doors	Add \$20.00
120" 120" Device for 10'0" doors	Add \$50.00
KS Key Stop Installed	Add \$5.00
CD Cylinder Dogging	N/C*
LD Less Dogging	N/C*
96B Dust Proof Strike	Add \$42.00

NOTE - Cylinders not included. Products on this page can be ordered with cylinders (C65) or interchangeable core housings (IC7) pre-installed at Detex prior to shipping (See page 64).



VALUE SERIES®

V50xNS/V51xNS SERIES NARROW STILE SURFACE VERTICAL ROD EXIT DEVICE

Baseplate Finish

Outside Function	Top & Bottom Rod Device	Top Rod Only Device	628 (Std.) Aluminum	711 Black
Device Only - Exit Only No Trim	V50xNS	V51xNS	\$779.00	\$789.00
Device/Function/Trim				
01 Cover Plate	V5001PNxNS	V5101PNxNS	\$862.00	\$872.00
02 Dummy Pull Trim	V5002ANxNS	V5102ANxNS	\$867.00	\$877.00
	V5002WPxNS	V5102WPxNS	\$978.00	N/A
03 Key Retracts Latch Pull trim	V5003PNxNS	V5103PNxNS	\$862.00	\$872.00
03 Key Retracts Latch Cylinder trim	V5003WSxNS	V5103WSxNS	\$924.00	\$977.00
03 Key Retracts Latch Pull Trim	V5003ANxNS	V5103ANxNS	\$867.00	\$877.00
.....				
08 Key Locks/Unlocks Outside Lever	V5008BNxNS	V5108BNxNS	\$1,050.00	\$1,060.00
09 Lever Trim Active by Key; Locked when key removed	V5009BNxNS	V5109BNxNS	\$1,050.00	\$1,060.00
14 Outside Lever Always Active	V5014BNxNS	V5114BNxNS	\$1,050.00	\$1,060.00

Note: Devices are shipped RHR unless specified LHR (Field Reversible)

DEVICE COMES STANDARD WITH:

- 628 Aluminum Baseplate
- HD Hex Dogging
- 36" 36" Device for 3 foot doors
- 84" 84" Rods for 7 foot doors
- 96 Surface Strike



FINISHES

Aluminum device extrusion is BHMA 628

Aluminum Trims:

- PN BHMA 628 (clear anodized aluminum)
- WS BHMA 626 (brushed chrome)
- AN and BN BHMA 689 (powder coated aluminum)

Black device extrusion is BHMA 711

Black Trims:

- PN BHMA 711 (black anodized aluminum)
- WS BHMA 613 (oil rubbed bronze)
- AN and BN BHMA 693 (powder coated black)

OPTIONS





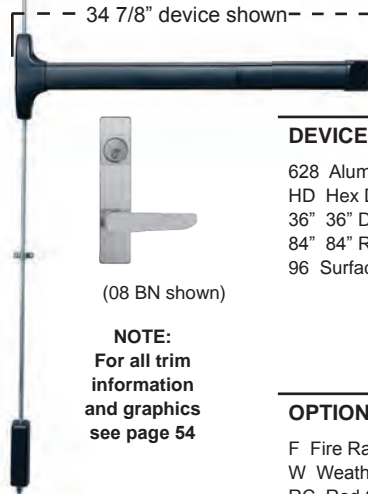

F Fire Rated - Specify prefix F (ex. FV50)	Add \$125.00
W Weatherized (Mechanical only - For weatherized electrified functions, see Electrified Functions)	Add \$79.00
RC Rod Covers Stainless Steel Finish - (ex. V50xRC)	Add \$190.00
BG Bottom Bolt Guard 12" ramped per ADA - (ex. V50xBG)	Add \$110.00
RCxBG Rod Covers and Bottom Bolt Guard - (ex. V50xRCxBG)	Add \$300.00
Electrified Options - see pages 57-61	
48" 48" Device for 4'0" doors	Add \$31.00
96" 96" Rods for 8'0" doors	Add \$20.00
120" 120" Device for 10'0" doors	Add \$50.00
KS Key Stop Installed	Add \$5.00
CD Cylinder Dogging	N/C*
LD Less Dogging	N/C*
96B Dust Proof Strike	Add \$42.00

NOTE - Cylinders not included. Products on this page can be ordered with cylinders (C65) or interchangeable core housings (IC7) pre-installed at Detex prior to shipping (See page 64).

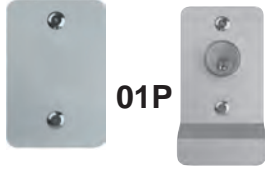

NOTE:
For all trim information and graphics see page 54

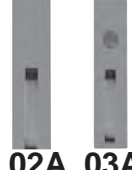

P Trim	WP Trim	PN Trim	WS Trim	A Trim	AN Trim
 01P 03P	 02WP	 01PN 03PN	 03WS	 02A 03A	 02AN 03AN

Function	Description	Trim	628 (Std.) Aluminum	or	711 Black
01	Cover plate	P	\$83.00		\$83.00
03*	Key retracts latch	P	\$83.00		\$83.00
02	Dummy Pull (Wire)	WP	\$199.00		N/A
01	Cover plate	PN	\$83.00		\$83.00
03*	Key retracts latch	PN	\$83.00		\$83.00
03*	Key retracts latch	WS	(630 Finish) \$145.00	(693 Finish)	\$188.00
02	Dummy pull	A	\$88.00		\$88.00
02	Dummy pull	AN	\$88.00		\$88.00
03*	Key retracts pull	A	\$88.00		\$88.00
03*	Key retracts pull	AN	\$88.00		\$88.00

(WS Trim Only - 626 = Brushed Chrome; 605, 606, 611, 612, 613, 625 = Other Finishes)

BN Trim for Value Series Devices (Includes 161 cover plate)

 EU2W	 08BN 09BN	 02BN 14BN	 S Lever - Standard	 08D2W 09D2W	 02D2W 14D2W
<p>Note: BN lever trims not for use in corrosive environments, see Advantex DN lever trims</p>					

Function	Description	Trim	628 (Std.) Aluminum	or	693 Black
02	Dummy pull	BN	\$271.00		\$271.00
08**	Key locks/unlocks outside lever	BN	\$271.00		\$271.00
09**	Lever trim active by key; locked when key removed	BN	\$271.00		\$271.00
14	Outside lever always active	BN	\$271.00		\$271.00
EU**	Electric Lock/Unlock Wide Escutcheon	EU2W	\$938.00		N/A

(For EU specify Fail Secure [FSE - std.] or Fail Safe [FSA] and specify handing)

For Vandal resistant, wide stile lever trims, for use with Value Series, specify 08D2W or 09D2W (See Advantex 08D or 09D for pricing)

NOTE: Lever Trims are shipped RHR unless specified LHR (Field Reversible)

* Rim cylinder not included (order separately - see page 64)

**Mortise cylinder not included (order separately - see page 64)



103789 Cylinder Nut Socket
100783 Cylinder Nut
See page 96 for more information

PULLS & PLATES

BHMA Function	BHMA Definition	Description	VALUE SERIES®	Manufacturer A Exit Devices	Manufacturer B Exit Devices
			Standard Value Series	Standard 19-R Series	Standard 51 Series
01	Exit Only	Cover Plate	01P; 01PN	930EO	501
02	Pull When Dogged	Dummy Pull	02A; 02AN	910DT	702A
02	Pull When Dogged	Dummy Pull (Wire)	02WP	N/A	N/A
03	Key Retracts Latch Bolt	Night Latch Pull	03A; 03AN	NA/910NL	703A
			03P; 03PN	N/A/920NL	603
03	Key Retracts Latch Bolt	Night Latch - Cylinder Only - Pull by Others	03WS	930C	N/A

LEVER TRIMS

BHMA Function	BHMA Definition	Description	VALUE SERIES®	Manufacturer A Exit Devices	Manufacturer B Exit Devices
			Standard Value Series	Standard 19 Series	Standard 51 Series
08	Key Locks/Unlocks Lever	Classroom Lever	08BN	912L	808A
09	Lever Active by Key; Locked when key removed	Night Latch Lever / Storeroom Lever	09BN	912LNL	N/A
14	Lever Always Active	Passage Lever	14BN	912L-BE	814A
EU	Electric Lock/Unlock	Fail Safe/Fail Secure	EU2W	See FSA/FSE	N/A

SERIES TYPE
V40 = Rim device, wide stile
V40xW = Weatherized Rim device, wide stile
HV40 = Rim device, wide stile, hurricane rated
V50 = Surface Vertical Rod, top rod only
V51 = Surface Vertical Rod, top rod only

OUTSIDE TRIM FINISH
628 = Aluminum * - P & PN
689 = Powder coated aluminum - A, AN & BN
693 = Powder coated black - A, AN & BN
626 = Brushed Chrome - WS
711 = Black anodized aluminum - P & PN

PUSH PAD
BLK = Black Push Pad (Standard on all VS except EB, EBxW, EE, EH, EHxR, EI & EM)
RWE = Red Push Pad White English
 Contact Factory for additional languages

CYLINDERS INSTALLED
C65 = 5 pin cylinder installed
IC7 = 7 pin IC housing installed

DOOR WIDTH/DEVICE LENGTH
36" wide door (3) *
48" wide door (4)

SN1 = Sex nut kit (2 per kit)
NS = Narrow stile for 2" narrow stile glass door applications
RC = Rod covers (630 brushed stainless)
BG = Bottom bolt and 12" ADA ramped cover (630 brushed stainless)

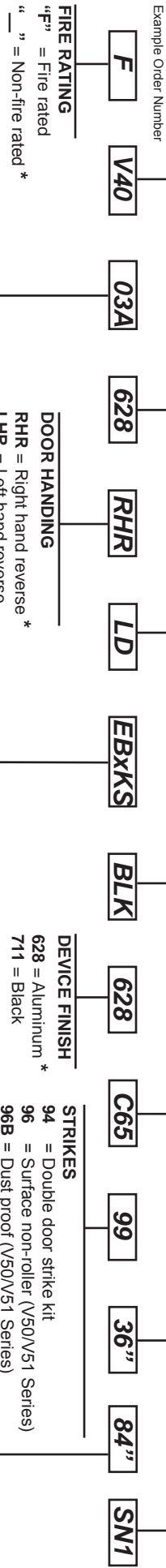

NOTE: Optional 2, 10 or 20 minute auto rearm available with EB, EBxW, EH & EHxR (Alarm resets after programmed time)

NOTE: * = default
 Contact factory for availability of combined options

Exit Alarm (EB) - Battery Powered - Available on all VS Devices	Price
Standard Package Includes:	Add \$202.00
- Switch monitors pushpad	
- Green & Red LED, cylinder arming, 9 Volt battery and piezo horn	
- Cylinder Dogging (CD) standard except for "F" (Fire Rated) device	
- Pushpad Signage "Push to Open Alarm Will Sound"	
EB Options	
KS - Key Stop Option Installed at Factory	Add \$5.00
FC - Flexible 3' Conduit Loop and Endcap Connector	Add \$35.00
LD - Less Dogging	N/C
BLK - Black pushpad - (includes peel & stick door signage - "Emergency Exit Only Alarm Will Sound")	N/C
LBM - Latch Bolt Monitoring - V40 only (alarm triggered by dead latch)	Add \$38.00
EB Accessories	
BE-961-1 - Battery Eliminator 9VDC Power Source	\$259.00

Weatherized Exit Alarm (EBxW) - Battery Powered - Available on all VS Devices	Price
Standard Package Includes:	Add \$420.00
- Remote signaling, remote bypass, pushpad monitoring	
- Green & Red LED, cylinder arming, 9 Volt battery and piezo horn	
- Cylinder Dogging (CD) standard except for "F" (Fire Rated) device	
- Pushpad Signage "Push to Open Alarm Will Sound"	
EBxW Options	
KS - Key Stop Option Installed at Factory	Add \$5.00
LD - Less Dogging	N/C
BLK - Black pushpad - (includes peel & stick door signage - "Emergency Exit Only Alarm Will Sound")	N/C
EBxW Accessories	
BE-961-1 - Battery Eliminator 9VDC Power Source	\$259.00

Exit Alarm (EH) - Hardwired 12V - 24 VAC/DC - Available on all VS Devices	Price
Standard Package Includes:	Add \$291.00
- Switch monitors pushpad	
- Cylinder Dogging (CD) standard except for "F" (Fire Rated) device	
- 120V to 12VAC Transformer and 9V Battery Backup	
- Flexible 3' Conduit Loop and Endcap Connector	
- Pushpad Signage "Push to Open Alarm Will Sound"	
EH Options	
KS - Key Stop Option Installed at Factory	Add \$5.00
LD - Less Dogging	N/C
BLK - Black pushpad - (includes peel & stick door signage - "Emergency Exit Only Alarm Will Sound")	N/C
IN - 220V to 24VAC Transformer substituted for standard transformer	N/C
277 - 277V to 24VAC Transformer substituted for standard transformer	Add \$45.00
LBM - Latch Bolt Monitoring - V40 only (alarm triggered by dead latch)	Add \$38.00
EH Accessories	
PT-5 - Power Transfer	Add \$134.00
EW8-626 - Electric Hinge	Add \$329.00

Exit Alarm with Remote Signal (EHxR) - Hardwired 12V - 24 VAC/DC - Available on all VS Devices	Price
Standard Package Includes	Add \$337.00
- Switch monitors pushpad	
- Cylinder Dogging (CD) standard except for "F" (Fire Rated) device	
- 120V to 12VAC Transformer and 9V Battery Backup	
- Flexible 3' Conduit Loop and Endcap Connector	
- Pushpad Signage "Push to Open Alarm Will Sound"	
<u>EHxR Options</u>	
KS - Key Stop Option Installed at Factory	Add \$5.00
LD - Less Dogging	N/C
BLK - Black pushpad - (includes peel & stick door signage - "Emergency Exit Only Alarm Will Sound")	N/C
IN - 220V to 24VAC Transformer substituted for standard transformer	N/C
277 - 277V to 24VAC Transformer substituted for standard transformer	Add \$45.00
LBM - Latch Bolt Monitoring (alarm triggered by dead latch)	Add \$38.00
<u>EHxR Accessories</u>	
PT-5 - Power Transfer	Add \$134.00
EWH8-626 - Electric Hinge	Add \$329.00

Electric Dogging (ED) - Available on all VS Devices	Price
Standard Package Includes:	Add \$420.00
- On-board switching requires initial manual pushpad depression after electric activation	
- Long-term dogging	
(Note: A 24V power supply or logic controller is required for ED but not included.)	
(Note: Most applications with ED require a power switch. - See pages 114-115)	
<u>ED Options</u>	
IN - 220V to 24VAC Transformer substituted for standard transformer	N/C
EX - Request to Exit Switching (example EDxEX)	Add \$129.00
<u>ED Accessories</u>	
CS462 Keyswitch (For other keyswitch and push button options, see pages 114-115)	\$176.00
PP-5152-2 24VAC Transformer	Add \$69.00
90-800 Power Supply for filtered, regulated power and simplified fire loop connections	See Page 68
FC - Flexible 3' Conduit Loop and Endcap Connector	Add \$35.00
PT-5 - Power Transfer	Add \$134.00
EWH8-626 - Electric Hinge	Add \$329.00

Electric Latch Retraction (ER) - Available on all VS Devices	Price
Standard Package Includes	Add \$899.00
- Simultaneous latch and pushpad retraction	
- FC - Flexible 3' Conduit Loop and Endcap Connector	
- Long term dogging capability	
- Switches to monitor pushpad, latch bolt and outside trim input	
(Note: A Logic Controller and Power Supply is required for ER but not included in standard package)	
<u>Required ER Accessories</u>	
81-800 Power Supply Controller For Latch Retraction - Single Door	See page 68
82-800 Power Supply Controller For Latch Retraction - Pair of Doors Simultaneous	See page 68
83-800 Power Supply Controller For Latch Retraction - Pair of Doors Independent	See page 68
<u>Optional ER Accessories</u>	
PT-5 - Power Transfer	Add \$134.00
EWH8-626 - Electric Hinge	Add \$329.00
EX - Request to Exit Switching (example ERxEX)	Add \$129.00

Electric Lock/Unlock (EU2W) Lever - Contact factory for use on medium and wide stile doors	Price
See Value Series Trim Page 54 for complete information	Add \$938.00

Delayed Egress (EE) - Available on all VS Devices	Price
---	-------

Standard Package Includes: Add \$1,389.00

- 15 second Delayed Egress with dead latch monitoring
- 15 second arming delay (AD) with extended bypass (alarm arms after door closes)
- 1 second nuisance delay
- Comes standard with 24V Filtered and Regulated Power Supply with simplified fire loop connections
- 24V Filtered and Regulated Power Supply with simplified fire loop connections.

(NOTE: Detex Power Supply required and included with standard EE Package, can power both devices for a pair of doors, specify V40xEEExPSO for second door)

- Cylinder Dogging (CD) standard except "F" (Fire Rated) device
- Delayed Egress Door Sign (ECL-395 English, 15 seconds, Red)
- Flexible 3' Conduit Loop and Endcap Connector, Pushpad Signage "Push to Open Alarm Will Sound"

For non-standard arming delay, non-standard nuisance delay, non-extended bypass, set grant times and other non-standard options or features, contact factory.

EE Options

KS - Key Stop Option Installed at Factory	Add \$5.00
LD - Less Dogging	N/C
30 - 30 Second Delayed Egress (example EEx30) (NOTE: Requires pre-approval letter from AHJ)	N/C
Substitute Door Signage Available in various languages (See Accessories - page 65)	N/C
BLK - Black pushpad - (includes peel & stick door signage - "Emergency Exit Only Alarm Will Sound")	N/C

EE Accessories

PT-5 - Power Transfer	Add \$134.00
EWH8-626 - Electric Hinge	Add \$329.00

Delayed Egress Magnetic Locking (EM) - Available on V40 Devices	Price
---	-------

Standard Package Includes: Add \$1,700.00

- 15 second Delayed Egress with dead latch monitoring
- 24V Filtered and Regulated Power Supply with simplified fire loop connections.
- (NOTE: Detex Power Supply required and included with standard EM Package)**
- Cylinder Dogging (CD) standard except for "F" (Fire Rated) device
- Magnetic Lock
- Delayed Egress Door Sign (ECL-395 English, 15 seconds, Red)
- Flexible 3' Conduit Loop and Endcap Connector
- Pushpad Signage "Push to Open Alarm Will Sound"

EM Options

KS - Key Stop Option Installed at Factory	Add \$5.00
LD - Less Dogging	N/C
30 - 30 Second Delayed Egress (example EMx30) (NOTE: Requires pre-approval letter from AHJ)	N/C
Substitute Door Signage Available in various languages (See Accessories - Page 65)	N/C
BLK - Black pushpad - (includes peel & stick door signage)	N/C

EM Accessories

PT-5 - Power Transfer	Add \$134.00
EWH8-626 - Electric Hinge	Add \$329.00

Electric Integration (EI) - Available on V40 Devices	Price
Standard Package Includes:	Add \$170.00
- Switches to monitor dead latch and outside trim input	
- Green and Red LED, cylinder arming and piezo horn (logic & power supply separate)	
- Cylinder Dogging (CD) standard except for "F" (Fire Rated) device	
- Black pushpad with peel and stick door signage "Push To Exit Alarm Will Sound"	
(Note: A Logic Controller is required for EI but not included in standard package)	
EI Options	
KS - Key Stop Option Installed at Factory	Add \$5.00
LD - Less Dogging	N/C
RWE - Red pushpad with white signage (English) other languages available	N/C
EI Accessories	
10-800 or 11-800 - Logic Controller & Power Supply for Electric Integration	See Page 70
FC - Flexible 3' Conduit Loop and Endcap Connector	Add \$35.00
PT-5 - Power Transfer	Add \$134.00
EWH8-626 - Electric Hinge	Add \$329.00

Electric Switching (ES) - Available on V40 Devices	Price
Standard Package Includes:	Add \$145.00
- Switching monitors dead latch and outside trim input	
- HD (Hex Dogging) standard except for "F" (Fire Rated) device	
- Black pushpad with peel and stick door signage "Push to Exit Alarm Will Sound"	
ES Options	
FC - Flex 3' Conduit Loop and Endcap Connector	Add \$35.00
CD - Cylinder Dogging	N/C
LD - Less Dogging	N/C
RWE - Red pushpad with white signage (English) other languages available	N/C
ES Accessories	
PT-5 - Power Transfer	Add \$134.00
EWH8-626 - Electric Hinge	Add \$329.00

Request to Exit Signaling (EX) - Available on all VS Devices	Price
Standard Package Includes:	Add \$132.00
- Switch monitors pushpad	
- Hex Dogging (HD) standard except for "F" (Fire Rated) device	
- Black pushpad with peel and stick door signage "Push To Exit Alarm Will Sound"	
EX Options	
FC - Flex 3' Conduit Loop and Endcap Connector	Add \$35.00
CD - Cylinder Dogging	N/C
LD - Less Dogging	N/C
RWE - Red pushpad with white signage (English) other languages available	N/C
EX Accessories	
PT-5 - Power Transfer	Add \$134.00
EWH8-626 - Electric Hinge	Add \$329.00

VALUE SERIES® ELECTRIFIED OPTIONS CONT'D

Weatherized Request to Exit Signaling (EXxW) - Available on all VS Devices	Price
Standard Package Includes:	Add \$148.00
- Weatherized Switch monitors push pad	
- Hex Dogging (HD) standard except for "F" (Fire Rated) device	
- Black pushpad with peel and stick door signage "Push To Exit Alarm Will Sound"	
EXxW Options	
FC - Flexible 3' Conduit Loop and Weather Resistant Endcap Connector - (Order Separately)	\$47.00
CD - Cylinder Dogging	N/C
LD - Less Dogging	N/C
RWE - Red pushpad with White Signage (English) other languages available	N/C
EXxW Accessories	
PT-5 - Power Transfer	Add \$134.00
EWH8-626 - Electric Hinge	Add \$329.00

Request to Exit Switching for High Current (EXV) - Available on All VS Devices	Price
Standard Package Includes:	Add \$212.00
- 3 AMP Switch monitors pushpad	
- Hex Dogging (HD) standard except for "F" (Fire Rated) device	
EXV Options	
FC - Flex Conduit and Endcap (example EXVxFC)	Add \$35.00
CD - Cylinder Dogging	N/C
LD - Less Dogging	N/C
2 - Includes 2 High Current Switches (EXV2)	Add \$310.00
EXV Accessories	
PT-5 - Power Transfer	Add \$134.00
EWH8-626 - Electric Hinge	Add \$329.00

Weatherized Request to Exit Switching for High Current (EXVxW) - Available on All VS Devices	Price
Standard Package Includes:	Add \$228.00
- Weatherized 3 AMP Switch monitors pushpad	
- Hex Dogging (HD) standard except for "F" (Fire Rated) device	
EXV Options	
FC - Flex Conduit and Endcap (example EXVxFC)	Add \$35.00
CD - Cylinder Dogging	N/C
LD - Less Dogging	N/C
2 - Includes 2 High Current Switches (EXV2)	Add \$310.00
EXV Accessories	
PT-5 - Power Transfer	Add \$134.00
EWH8-626 - Electric Hinge	Add \$329.00

628 Base Price	FB	EBXW	ED	FE	EH	EHR	EI	EM	EB	ES	EX	EXM	EXY	EXYM
	\$202	\$420	\$420	\$1,389	\$291	\$337	\$170	\$1,700	\$899	\$145	\$132	\$148	\$212	\$228
V40 Rim (device only)	\$368	788	788	1,757	659	705	538	2,068	1,267	513	500	516	580	596
V4001 P (cover plate)	\$451	871	871	1,840	742	788	621	2,151	1,350	596	583	599	663	679
V4001 PN (cover plate)	\$451	871	871	1,840	742	788	621	2,151	1,350	596	583	599	663	679
V4003 P (key retracts latch pull trim)	\$451	871	871	1,840	742	788	621	2,151	1,350	596	583	599	663	679
V4003 PN (key retracts latch pull trim)	\$451	871	871	1,840	742	788	621	2,151	1,350	596	583	599	663	679
V4003 WS (key retracts latch pull trim)	\$513	933	933	1,902	804	850	683	2,213	1,412	658	645	661	725	741
V4002 A (dummy pull)	\$456	876	876	1,845	747	793	626	2,156	1,355	601	588	604	668	684
V4002 AN (dummy pull)	\$456	876	876	1,845	747	793	626	2,156	1,355	601	588	604	668	684
V4002 D2W (dummy lever)	\$780	982	1,200	2,169	1,071	1,117	950	2,480	1,679	925	912	928	992	1,008
V4002 WP (dummy pull - wire)	\$567	769	987	1,956	858	904	737	2,267	1,466	712	699	715	779	795
V4003 A (key retracts latch pull trim)	\$456	876	876	1,845	747	793	626	2,156	1,355	601	588	604	668	684
V4003 AN (key retracts latch pull trim)	\$456	876	876	1,845	747	793	626	2,156	1,355	601	588	604	668	684
V4008 BN (key locks/unlocks outside lever)	\$639	841	1,059	2,028	930	976	809	2,339	1,538	784	771	787	851	867
V4008 D2W (key locks/unlocks outside lever)	\$820	1,022	1,240	2,209	1,111	1,157	990	2,520	1,719	965	952	968	1,032	1,048
V4009 BN (lever active by key; locked when key removed)	\$639	841	1,059	2,028	930	976	809	2,339	1,538	784	771	787	851	867
V4009 D2W (lever active by key; locked when key removed)	\$820	1,022	1,240	2,209	1,111	1,157	990	2,520	1,719	965	952	968	1,032	1,048
V4014 BN (outside lever always active)	\$639	841	1,059	2,028	930	976	809	2,339	1,538	784	771	787	851	867
V4014 D2W (outside lever always active)	\$820	1,022	1,240	2,209	822	1,157	990	2,520	1,719	965	952	968	1,032	1,048
V40 EU (electric lock/unlock)	\$1,306	1,508	1,726	2,695	1,597	1,643	1,476	3,006	2,205	1,451	1,438	1,454	1,518	1,534
V40xNS Narrow Stile Rim (device only)	\$202	\$420	\$420	\$1,389	\$291	\$337	\$170	\$1,700	\$899	\$145	\$132	\$148	\$212	\$228
V4001 PNXS (cover plate)	\$418	620	838	1,807	709	755	588	2,118	1,317	563	550	566	630	646
V4001 PNXS (cover plate)	\$501	703	921	1,890	792	838	671	2,201	1,400	646	633	649	713	729
V4001 PNXS (cover plate)	\$501	703	921	1,890	792	838	671	2,201	1,400	646	633	649	713	729
V4003 PNXS (key retracts latch pull trim)	\$501	703	921	1,890	792	838	671	2,201	1,400	646	633	649	713	729
V4003 PNXS (key retracts latch pull trim)	\$501	703	921	1,890	792	838	671	2,201	1,400	646	633	649	713	729
V4003 WxNS (key retracts latch pull trim)	\$563	765	983	1,952	854	900	733	2,263	1,462	708	695	711	775	791
V4002 AxNS (dummy pull)	\$506	708	926	1,895	797	843	676	2,206	1,405	651	638	654	718	734
V4002 ANxNS (dummy pull)	\$506	708	926	1,895	797	843	676	2,206	1,405	651	638	654	718	734
V4002 D2WxNS (dummy lever)	\$830	1,032	1,250	2,219	1,121	1,167	1,000	2,530	1,729	975	962	978	1,042	1,058
V4002 WPxNS (dummy pull - wire)	\$617	819	1,037	2,006	908	954	787	2,317	1,516	762	749	765	829	845
V4003 AxNS (key retracts latch pull trim)	\$506	708	926	1,895	797	843	676	2,206	1,405	651	638	654	718	734
V4003 ANxNS (key retracts latch pull trim)	\$506	708	926	1,895	797	843	676	2,206	1,405	651	638	654	718	734
V4008 BNxNS (key locks/unlocks outside lever)	\$689	891	1,109	2,078	980	1,026	859	2,389	1,588	834	821	837	901	917
V4008 D2WxNS (key locks/unlocks outside lever)	\$870	1,072	1,290	2,259	1,161	1,207	1,040	2,570	1,769	1,015	1,002	1,018	1,082	1,098
V4009 BNxNS (lever active by key; locked when key removed)	\$689	891	1,109	2,078	980	1,026	859	2,389	1,588	834	821	837	901	917
V4009 D2WxNS (lever active by key; locked when key removed)	\$870	1,072	1,290	2,259	1,161	1,207	1,040	2,570	1,769	1,015	1,002	1,018	1,082	1,098
V4014 BNxNS (outside lever always active)	\$689	891	1,109	2,078	980	1,026	859	2,389	1,588	834	821	837	901	917
V4014 D2WxNS (outside lever always active)	\$870	1,072	1,290	2,259	872	1,207	1,040	2,570	1,769	1,015	1,002	1,018	1,082	1,098
V40 EUxNS (electric lock/unlock)	\$1,356	1,558	1,776	2,745	1,647	1,693	1,526	3,056	2,255	1,501	1,488	1,504	1,568	1,584

EASY PRICE REFERENCE CHART CONT'D ON PAGE 63

628 Base Price	EB	EBXW	ED	EH	EH	EHR	EI	EM	ER	ES	EX	EXW	EXV	EXVM
	\$202	\$420	\$1,389	\$291	\$337	N/A	N/A	\$899	\$132	N/A	\$212	\$228		
V50/V51 Surface Vertical Rod (device only)														
V5001 P (cover plate)	\$729	931	1,149	N/A	\$1,389	\$291	\$337	N/A	N/A	N/A	\$899	\$132	N/A	\$212
V5001 PN (cover plate)	\$812	1,014	1,232	N/A	2,201	1,020	1,066	N/A	1,628	N/A	861	941	957	
V5003 P (key retracts latch pull trim)	\$812	1,014	1,232	N/A	2,201	1,020	1,066	N/A	1,628	N/A	861	941	957	
V5003 PN (key retracts latch pull trim)	\$812	1,014	1,232	N/A	2,201	1,020	1,066	N/A	1,628	N/A	861	941	957	
V5003 WS (key retracts latch pull trim)	\$812	1,014	1,232	N/A	2,201	1,020	1,066	N/A	1,628	N/A	861	941	957	
V5002 A (dummy pull)	\$874	1,076	1,294	N/A	2,263	1,165	1,211	N/A	1,773	N/A	1,006	1,086	1,102	
V5002 AN (dummy pull)	\$817	1,019	1,237	N/A	2,206	1,108	1,154	N/A	1,716	N/A	949	1,029	1,045	
V5002 D2W (dummy lever)	\$1,141	1,343	1,561	N/A	2,530	1,432	1,478	N/A	2,040	N/A	1,273	1,353	1,369	
V5002 WP (dummy pull - wire)	\$928	1,130	1,348	N/A	2,317	1,219	1,265	N/A	1,827	N/A	1,060	1,140	1,156	
V5003 A (key retracts latch pull trim)	\$817	1,019	1,237	N/A	2,206	1,108	1,154	N/A	1,716	N/A	949	1,029	1,045	
V5003 AN (key retracts latch pull trim)	\$817	1,019	1,237	N/A	2,206	1,108	1,154	N/A	1,716	N/A	949	1,029	1,045	
V5008 BN (key locks/unlocks outside lever)	\$1,000	1,202	1,420	N/A	2,389	1,291	1,337	N/A	1,899	N/A	1,132	1,212	1,228	
V4008 D2W (key locks/unlocks outside lever)	\$1,181	1,383	1,601	N/A	2,570	1,472	1,518	N/A	2,080	N/A	1,313	1,393	1,409	
V5009 BN (lever active by key; locked when key removed)	\$1,000	1,202	1,420	N/A	2,389	1,291	1,337	N/A	1,899	N/A	1,132	1,212	1,228	
V5009 D2W (lever active by key; locked when key removed)	\$1,181	1,383	1,601	N/A	2,570	1,472	1,518	N/A	2,080	N/A	1,313	1,393	1,409	
V5014 BN (outside lever always active)	\$1,000	1,202	1,420	N/A	2,389	1,291	1,337	N/A	1,899	N/A	1,132	1,212	1,228	
V5014 D2W (outside lever always active)	\$1,181	1,383	1,601	N/A	2,570	1,472	1,518	N/A	2,080	N/A	1,313	1,393	1,409	
V50 EU (electric lock/unlock)	\$1,667	1,869	2,087	N/A	3,056	1,958	2,004	N/A	2,566	N/A	1,799	1,879	1,895	
V50/V51xNS Narrow Stile Surface Vertical Rod (device only)														
V5001 P xNS (cover plate)	\$779	981	1,199	N/A	\$1,389	\$291	\$337	N/A	\$899	N/A	\$132	\$212	\$228	
V5001 PN xNS (cover plate)	\$862	1,064	1,282	N/A	2,168	1,070	1,116	N/A	1,678	N/A	911	991	1,007	
V5003 P xNS (key retracts latch pull trim)	\$862	1,064	1,282	N/A	2,251	1,153	1,199	N/A	1,761	N/A	994	1,074	1,090	
V5003 PN xNS (key retracts latch pull trim)	\$862	1,064	1,282	N/A	2,251	1,153	1,199	N/A	1,761	N/A	994	1,074	1,090	
V5003 W xNS (key retracts latch pull trim)	\$862	1,064	1,282	N/A	2,251	1,153	1,199	N/A	1,761	N/A	994	1,074	1,090	
V5002 A xNS (dummy pull)	\$924	1,126	1,344	N/A	2,313	1,215	1,261	N/A	1,823	N/A	1,056	1,136	1,152	
V5002 AN xNS (dummy pull)	\$867	1,069	1,287	N/A	2,256	1,158	1,204	N/A	1,766	N/A	999	1,079	1,095	
V5002 D2W xNS (dummy lever)	\$867	1,069	1,287	N/A	2,256	1,158	1,204	N/A	1,766	N/A	999	1,079	1,095	
V5002 WP xNS (dummy pull - wire)	\$1,191	1,393	1,611	N/A	2,580	1,482	1,528	N/A	2,090	N/A	1,323	1,403	1,419	
V5003 A xNS (key retracts latch pull trim)	\$867	1,069	1,287	N/A	2,256	1,158	1,204	N/A	1,766	N/A	999	1,079	1,095	
V5003 AN xNS (key retracts latch pull trim)	\$867	1,069	1,287	N/A	2,256	1,158	1,204	N/A	1,766	N/A	999	1,079	1,095	
V5008 BN xNS (key locks/unlocks outside lever)	\$1,050	1,252	1,470	N/A	2,439	1,341	1,387	N/A	1,949	N/A	1,182	1,262	1,278	
V4008 D2W xNS (key locks/unlocks outside lever)	\$1,231	1,433	1,651	N/A	2,620	1,522	1,568	N/A	2,130	N/A	1,363	1,443	1,459	
V5009 BN xNS (lever active by key; locked when key removed)	\$1,050	1,252	1,470	N/A	2,439	1,341	1,387	N/A	1,949	N/A	1,182	1,262	1,278	
V5009 D2W xNS (lever active by key; locked when key removed)	\$1,231	1,433	1,651	N/A	2,620	1,522	1,568	N/A	2,130	N/A	1,363	1,443	1,459	
V5014 BN xNS (outside lever always active)	\$1,050	1,252	1,470	N/A	2,439	1,341	1,387	N/A	1,949	N/A	1,182	1,262	1,278	
V5014 D2W xNS (outside lever always active)	\$1,231	1,433	1,651	N/A	2,620	1,522	1,568	N/A	2,130	N/A	1,363	1,443	1,459	
V50 EU xNS (electric lock/unlock)	\$1,717	1,919	2,137	N/A	3,106	2,008	2,054	N/A	2,616	N/A	1,849	1,929	1,945	

Electric Slide-In Filler Kits (For Service & Repair Parts - Contact Factory)			Price
SIFV-EB	Exit Alarm 9VDC (Battery Powered) Includes pushpad monitoring	SIFV-EB-36"	\$219.00
SIFV-EB-W	Weatherized Exit Alarm 9VDC (Battery Powered) Includes pushpad monitoring, remote signal & remote bypass	SIFV-EB-48" SIFV-EB-W-36" SIFV-EB-W-48"	\$228.00 \$463.00 \$476.00
SIFV-EH	Exit Alarm 12VAC - 24VAC (Hardwired) Includes pushpad monitoring	SIFV-EH-36" SIFV-EH-48"	\$292.00 \$302.00
SIFV-EH-R	Exit Alarm 12VAC - 24 VAC (Hardwired) Includes pushpad monitoring & remote signal	SIFV-EH-R-36" SIFV-EH-R-48"	\$360.00 \$370.00
SIFV-EX	Request to Exit Switching Includes pushpad monitoring Specify Cylinder Dogging (CD), Less Dogging (LD) or Hex Dogging (HD)	SIFV-EX-36" SIFV-EX-48"	\$137.00 \$143.00
SIFV-EX-W	Weatherized Request to Exit Switching Includes weatherized pushpad monitoring Specify Cylinder Dogging (CD), Less Dogging (LD) or Hex Dogging (HD)	SIFV-EX-W-36" SIFV-EX-W-48"	\$161.00 \$173.00
Relay Kits			Price
RLY12	12 VAC Relay Kit - For use with 12V alarms that have remote bypass feature. Used with remote bypass to shunt alarm and activate another electrified device - Separate J-Box required		\$57.00
RLY24	24 VAC Relay Kit - For use with 24V alarms that have remote bypass feature. Used with remote bypass to shunt alarm and activate another electrified device - Separate J-Box required		\$64.00
HD-CD-LD Slide-In Filler Kits			Price
SIFV-LD	Less Dogging Slide-In Filler Kit	SIFV-LD-36" SIFV-LD-48"	\$16.00 \$21.00
SIFV-HD	Hex Key Dogging Slide-In Filler Kit	SIFV-HD-36" SIFV-HD-48"	\$42.00 \$42.00
SIFV-CD	Cylinder Dogging Slide-In Filler Kit	SIFV-CD-36" SIFV-CD-48"	\$42.00 \$42.00
Cylinders and Accessories			Price (Factory Installed)
MC65	Mortise Cylinder, Schlage "C" Keyway, 1-1/8" 6-pin, Keyed 5-pin - Specify Finish	\$30.00	\$60.00
IC7	7-pin SFIC Mortise Cylinder Housing (Core not included)	\$30.00	\$60.00
RC65	Rim Cylinder, Schlage "C" Keyway, 6-pin, Keyed 5-pin (Also known as ECL-445K) - Specify Finish	\$30.00	\$60.00
CCL	Cylinder Collar, Long 11/16" - Specify Finish	\$30.00	
CCS	Cylinder Collar, Short 7/16" - Specify Finish	\$30.00	
CBK	Cylinder Bracket Kit (for rim cylinder used with other manufacturer's trim)	\$25.00	
SE-2	Shaft Extension Kit for Lever Trims for 2 - 2 1/2" thick door	\$55.00	
SE-25	Shaft Extension Kit for Lever Trims for 2 1/8 - 2 3/4" thick door	\$55.00	
SE-3	Shaft Extension Kit for Lever Trims for 2 5/8 - 3 1/4" thick door	\$88.00	
SE-35	Shaft Extension Kit for Lever Trims for 3 1/8 - 3 3/4" thick door	\$88.00	
SE-4	Shaft Extension Kit for Lever Trims for 3 5/8 - 4 1/4" thick door	\$88.00	
SE-65	Shaft Extension Kit for Lever Trims for 6 - 6 5/8" thick door	\$88.00	
Strike Kits			Price
94	Double Door Strike Kit with Tamper Resistant and Standard Fasteners (no security driver required)		\$57.00
96	Surface Non-Roller Strike (for V50/V51 Series Devices)		\$30.00
96B	Dust Proof Strike (for V50 Series Devices)		\$42.00
98	Semi-Mortise Strike		\$42.00
99	Surface Strike		\$35.00
SHK1	Strike Hook Kit (1 per package)		\$16.00
Hex Dogging Key			Price
HDK	Hex Dogging Key		\$3.00

Mounting Accessories		Price
NSK	Narrow Stile Door Kit (Can work for V40 and V50) Converts Standard Value Series Device to fit 2" stile - Specify Device Finish: 628 or 711	\$79.00
NSK-SVR	Narrow Stile Door Kit For Surface Vertical Rods (Only works for V50) Converts Standard Value Series Device to fit 2" stile - Specify Device Finish: 628 or 711	\$32.00
SN1	Sex Nut Kit 1/4"-20 (2 per pkg) - Specify Finish: 606, 613, 626	\$14.00
SSK3	Torx® Security Screw Kit for Value Series - Includes security tip driver and tamper resistant fasteners	\$38.00
Glass Bead Kit		Price
GB5	Glass Bead Kit - V50 Series (Used as 1/4" shim for flush doors with light kit moldings)	\$268.00
GB15	Glass Bead Kit - V40 Series (Used as 1/4" shim for flush doors with light kit moldings)	\$68.00
Flexible Conduit Loop Kits, Armored Cable Kits and Power Transfers		Price
FCV	Flex Conduit Kit includes conduit, endcap and fittings	FCV-3' \$46.00 FCV-10' \$69.00
FCV-W	Weatherized Flex Conduit Kit includes conduit, endcap, fittings and waterproof wire nuts	FCV-W-3' \$47.00 FCV-W-10' \$69.00
AL18	Surface Mount Flex Armor Loop, Alum Finish, 18" - Mounted to door and wall	\$60.00
JB1	Junction Box - Flex Conduit Kit (for use with EM to run wires to Magnetic Lock)	\$150.00
PT-5	Power Transfer	\$134.00
EWH8-626	Electric Hinge	\$329.00
Delayed Egress Peel and Stick Door Signage Chart		Price
PUSH UNTIL ALARM SOUNDS - DOOR CAN BE OPENED IN XX SECONDS		
ECL-395	English - 15 Second - Red (Standard)	\$13.00
ECL-395-1	English - 30 Second - Red	\$13.00
ECL-395-2	French/Canadian - 15 Second - Red	\$13.00
ECL-395-3	French/Canadian - 30 Second - Red	\$13.00
ECL-395-4	Spanish - 15 Second - Red	\$13.00
ECL-395-5	Spanish - 30 Second - Red	\$13.00
ECL-395-6	French - 15 Second - Green	\$13.00
ECL-395-7	French - 30 Second - Green	\$13.00
ECL-395-8	German - 15 Second - Green	\$13.00
ECL-395-9	German - 30 Second - Green	\$13.00
ECL-395-10	Chinese - 15 Second - Red	\$13.00
ECL-395-11	Chinese - 30 Second - Red	\$13.00
ECL-395-12	English European - 15 Second - Red	\$13.00
ECL-395-13	English European - 30 Second - Red	\$13.00
Peel and Stick Door Sign		Price
PUSH TO OPEN - ALARM WILL SOUND		
101802-1	English - Green	\$15.00
101802-2	French - Green	\$15.00
101802-3	German - Green	\$15.00
101802-4	Chinese - Red	\$15.00
101802-5	Spanish - Red	\$15.00
101802-6	French/Canadian - Red	\$15.00
Optional Value Series Pushpad Signage Chart		Price
PUSH TO OPEN - ALARM WILL SOUND		36" 48"
105417-1	Pushpad wrap kit - 3 foot Red	\$14.00
105417-2	Pushpad wrap kit - 4 foot Red	\$15.00
105417-3	Pushpad wrap kit - 3 foot Black	\$14.00
105417-4	Pushpad wrap kit - 4 foot Black	\$15.00
For Other Languages, Contact Factory		
Delayed Egress Outdoor Signage Chart		Price
PUSH UNTIL ALARM SOUNDS - DOOR CAN BE OPENED IN 15 SECONDS		
101906	English - 15 Second (Metal Sign - Non Adhesive)	\$75.00
101906-1	English - 30 Second (Metal Sign - Non Adhesive)	\$75.00

MODEL NO.	DESCRIPTION	PRICE
GTPLKIT	Gate Plate Kit - Includes Gate Latch Protector (GTPLGRD), GTSTKBKT (Strike Latch Receiver Bracket), GTPL (Adjustable Gate Plate - Does not come with Lockbox or Mounting Holes)	\$653.50

MODEL NO.	DESCRIPTION	PRICE
GTPL	Adjustable Gate Plate - Fits Single Gates 32" - 52" wide Fits square or round gate frames - Does not come with exit device mounting holes	\$400.00
03GS	Optional 03 function cylinder trim used on gates (Rim Cylinder sold separately)	\$94.00
08GSN	Spacer for Narrow Lever Trim	\$108.00
GTSTKBKT	Strike Latch Receiver Bracket	\$152.00
GTPLGRD	Gate Latch Protector	\$99.00

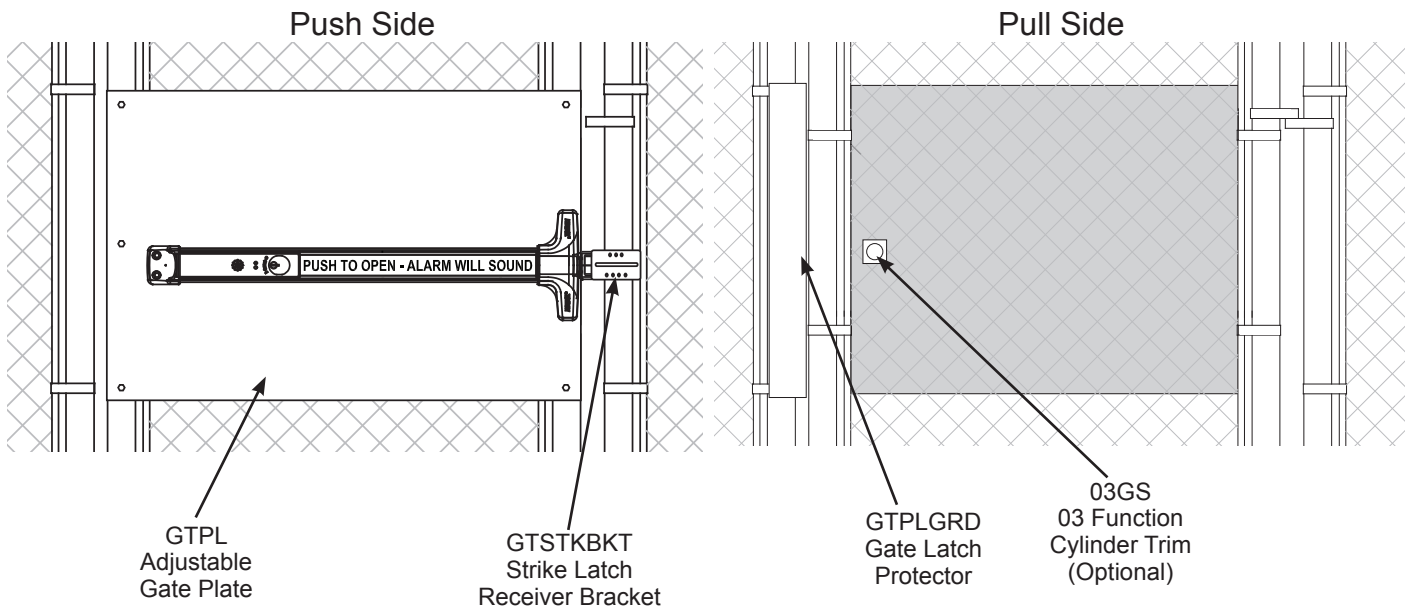

EXIT DEVICE SOLD SEPARATELY



For more information, see Value Series weatherized exit devices

NOTES

Series 800

CONTROLLERS AND POWER SUPPLIES

POWER SUPPLIES

	MODEL NO.	DESCRIPTION	PRICE
	90-800*	120VAC/24VDC Power Supply - 1.0A continuous Can be used with ED, EE, EM products	\$389.00
	xIN xLT	Optional - 240VAC Input Less Transformer	Add \$98.00 Subtract \$12.00
	80-800*	12 or 24VDC Power Supply - 1.0A continuous Can be used with ED, EE, EM products NOTE: Battery Charging Circuit included on all above (Battery sold separately)	\$529.00
	x220 M12	Optional - 220VAC Input 12 Volt Module	Add \$98.00 Add \$136.00

* Cover lock and keys sold separately - See Series 800 Accessories (71) to order.

POWER SUPPLY CONTROLLERS

For use with Latch Retraction

	MODEL NO.	DESCRIPTION	PRICE
	81-800*	Controller and Power Supply - 1 Amp continuous Powers and controls ER device for 1 door with signal output for 1 operator	\$829.00
	82-800*	Controller and Power Supply - 2 Amp continuous Powers and controls ER device for 1 pair of doors with signal output for 1 operator	\$1,012.00
	83-800*	Controller and Power Supply - 2 Amp continuous Powers and controls ER device for 2 independent doors with signal output for 2 operators NOTE: Battery Charging Circuit included on all above (Battery sold separately)	\$1,189.00
	x220 M12	Optional - 220VAC Input 12 Volt Module	Add \$98.00 Add \$136.00

* Cover lock and keys sold separately - See Series 800 Accessories (71) to order.

Series 800

CONTROLLERS AND POWER SUPPLIES CONT'D

POWER SUPPLY CONTROLLERS

For use with Advantex Delayed Egress With Latch Retraction

	MODEL NO.	DESCRIPTION	PRICE
 <p>84-800 or 85-800</p> <p>Remote Indicating Unit (RIU)</p> <p>Also includes wire harness with wiring</p>	84-800	Controller and Power Supply with Remote Indicating Unit - 1 Amp Continuous - Powers and controls EExER device for 1 door with signal output for 1 operator	\$1,746.00
	85-800	Controller and Power Supply with Remote Indicating Unit - Controller and Power Supply - 2 Amp continuous Powers and controls EExER device for 1 pair of doors with signal output for 1 operator	\$2,276.00
<p>* Standard defaults include: 15 second Arming, 15 second Delayed Egress, English Signage (RWE), 3 chirp Arming, Door Signal Module (DSM), Gray Remote Indicating Unit (RIU), Surface mounting, Dummy Plug (not installed), Rearm using key or access control (Powers 2 EExER Exit Devices - for 85-800 units only)</p>			

CONFIGURABLE OPTIONS - 84-800 / 85-800

MODEL NO.	DESCRIPTION	PRICE
8X-810	1 second Arming	N/C
8X-803	30 second Delayed Egress (AHJ letter required)	N/C
SA	Silent Arming	Add \$48.00
M12	12 VDC Module (Replaces DSM when ordering 85-800)	Add \$136.00
BLK	Black Remote Indicating Unit (RIU)	N/C
F	Flush Mounting	N/C
MC65	Mortise cylinder (Installed)	Add \$60.00
IC7	Interchangeable core housing (Installed)	Add \$60.00
KS	Key Stop	Add \$5.00
SSK	Security Screws for RIU	Add \$30.00
RKO	Rearm using Key only	Add \$50.00
ER	Powers (1) EExER and (1) ER Exit Device (for 85-800 units only)	Add \$98.00
EE	Powers (1) EExER and (1) EE Exit Device (for 85-800 units only)	Add \$98.00

Signage - Other languages available - contact factory

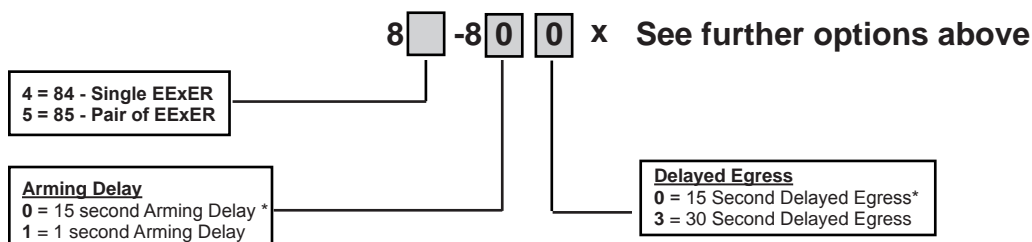







* Standard default

Series 800

CONTROLLERS AND POWER SUPPLIES CONT'D

LOGIC CONTROLLERS

	MODEL NO.	DESCRIPTION	PRICE
	10-800*	Series 800 Controller -Stand-Alone 120VAC/24VDC System contains back box, transformer and Series 800 electronics.	\$1,099.00
	11-800*	Series 800 Controller - Stand-Alone 120VAC/24VDC System contains back box, insert, 24 point terminal strip, transformer and Series 800 electronics	\$1,199.00
	60-2RMF	Relay board (2) DPDT, 24VDC output relays, sequence or independent, wet or dry, field selectable - Includes 12VDC@150mA output tap. Used with Series 800 logic controllers, offers an integration solution to multi controls and single-point terminations.	Add \$145.00
	30-800*	Series 800 Controller - 120VAC/24VDC Surface Box - Zinc Plated System contains back box w/ metal stand-off, lid and Series 800 electronics. Requires low-voltage remote source of power	\$859.00
	31-800	Series 800 Controller - 120VAC/24VDC Flat Mount Plate Requires low-voltage remote source of power	\$1,029.00
	40-800*	Series 800 Controller - 120VAC/24VDC Surface Box - Black System contains back box, upper back pan and flip-up insert with Series 800 electronics. Requires low-voltage remote source of power	\$1,129.00
	41-800* **	Series 800 Controller - 120VAC/24VDC Surface Box- Black Without Flip-up insert unit. Requires low-voltage remote source of power	\$1,089.00
	60-2RMF	Relay board (2) DPDT, 24VDC output relays, sequence or independent, wet or dry, field selectable - Includes 12VDC@150mA output tap. Used with Series 800 logic controllers, offers an integration solution to multi controls and single-point terminations.	Add \$145.00
	50-800	Circuit Board - 24VAC/24VDC - Comes with 5 stand-off, requires non-conductive support studs for proper installation	\$949.00
<p>*Cover lock and keys not included - See Controller & Power Supply Accessories (below) to order lock ** This application is generally used for integrated applications that require additional splice chamber room or for the pass through of cable, wire or circuit boards associated to low voltage systems. Preparation of upper back pan and flip-up portion of insert to suit other manufacturers components is available. For custom application, please call for quotation.</p>			

Series 800

ACCESSORIES

POWER SUPPLY ACCESSORIES

	MODEL NO.	DESCRIPTION	PRICE
	70-12B	Battery 12VDC 4AH	\$90.00
	70-24B	Battery 24VDC 4AH 2 batteries provided Includes linking cable (Battery Box not Included)	\$189.00
	M12	12 Volt Module	Add \$136.00
Signage sold separately - See ECL-395 (page 65) and EA-561 (page 99)			

CONTROLLER & POWER SUPPLY ACCESSORIES

	MODEL NO.	DESCRIPTION	PRICE
	L	Cover Lock and 2 keys	Add \$40.00
	T	Tamper Proof Sensor	Add \$40.00
	K1	Relay	Add \$30.00

CONTROLLER ACCESSORIES

	MODEL NO.	DESCRIPTION	PRICE
	60-06	Folding Insert Tray Add this to 10-800 Controller to provide space for digital timer or door call module	\$178.00

Signage sold separately - See ECL-395 (page 65) and EA-561 (page 99)

90 SERIES KEYED REMOVABLE MULLIONS

Removable Mullions

For use with Advantex®, Value Series®
& Other Rim Exit Devices

Rim Cylinder
Sold Separately

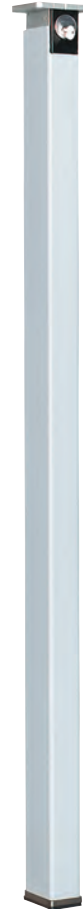

Standard Mullions	PRICE
90KR - Keyed Removable Mullion - 7 foot	\$641.00
90KR - Keyed Removable Mullion - 8 foot	\$641.00
90KR - Keyed Removable Mullion - 10 foot	\$702.00
Fire Rated Mullions	PRICE
F90KR - Fire Rated Keyed Removable Mullion - 7 foot	\$745.00
F90KR - Fire Rated Keyed Removable Mullion - 8 foot	\$745.00
Electrified Mullions	PRICE
90KREx7 - Electrified Keyed Removable Mullion - 7 foot	Add \$195.00
90KREx8 - Electrified Keyed Removable Mullion - 8 foot	Add \$195.00

Shipped less rim cylinder - Rim Cylinder available at additional cost (see page 96)



NOTE: Fire Rated Listing allows field location of strike. Detex Fire Rated Mullion can be strike-prepped in the field.

Detex Fire Rated Mullion can be used with other manufacturers exit devices that are fire rated for pairs of doors with a Mullion.



90 SERIES REMOVABLE MULLIONS

For use with Advantex®, Value Series®
& Other Rim Exit Devices

Hurricane Rated Mullions	PRICE
H90Rx7' - Hurricane Rated Removable Mullion (Not Keyed) - 7 foot (NOTE: Cylinder not required)	Contact Factory

NOTES

DETEX CORPORATION

Automatic Operator

Select from list below and fax to 800-653-3839

NOTE: Operator always mounted inside of building
Viewed from mounting side of door

- Single Door 39.5" Right Hand Push AL
 Qty _____ 45.5" Left Hand Push 11" + reveal BZ
 52" Pull Max reveal on a pull 2.5"

LH Push

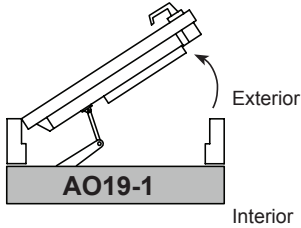

RH Push

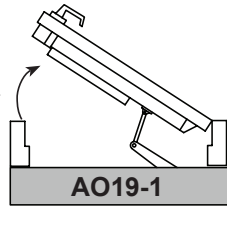

LH Pull

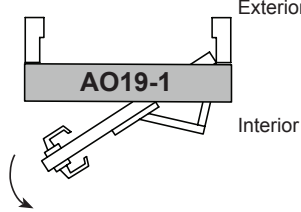

RH Pull

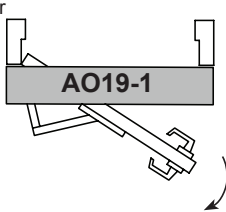

- Double Door (Twin) 75.5" Push AL Simultaneous
 Qty _____ 92" Push 11" + reveal BZ Independent
 100" Pull Max reveal on a pull 2.5"

Double Door (Twin) Push

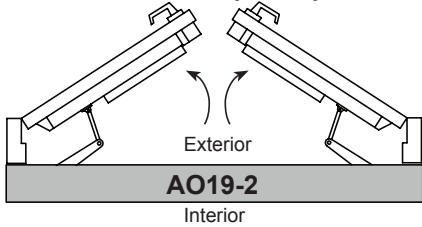

Double Door (Twin) Pull

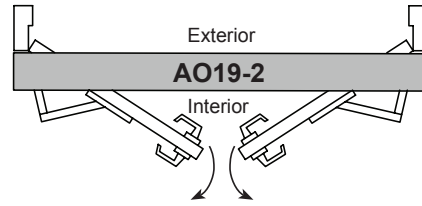

- Double Egress (Dual) Door 75.5" Right Hand Push AL Simultaneous
 Qty _____ 92" Left Hand Pull BZ Independent
 100" Max reveal on a pull 2.5"

Dual Egress Door RH

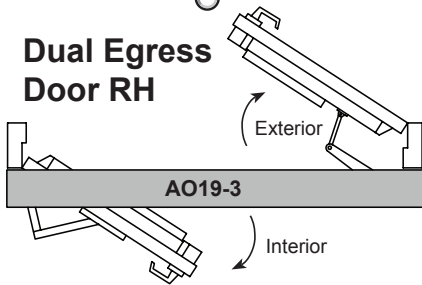

Dual Egress Door LH

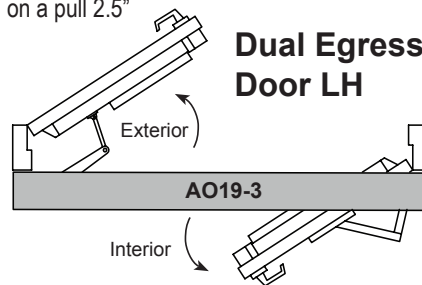

Distributor: _____ Date: _____

Ph # _____ Email: _____ PO # _____

Comments: _____

Model # _____ x (length) _____ x (push/pull/dual) _____ x (AL/BZ) _____

AO19 SERIES®

LOW ENERGY AUTOMATIC DOOR OPERATORS FOR SINGLE DOOR APPLICATIONS



Model Number	Description	Finish	
		Clear (xAL)	Bronze (xBZ)
AO19-1xLH Push	Single Door Left Hand Push	\$3,400.00	\$3,400.00
AO19-1xRH Push	Single Door Right Hand Push	\$3,400.00	\$3,400.00
AO19-1xLH Pull	Single Door Left Hand Pull	\$3,400.00	\$3,400.00
AO19-1xRH Pull	Single Door Right Hand Pull	\$3,400.00	\$3,400.00
DEVICE COMES STANDARD WITH:	AL - Clear Finish 39.5" Device for 3 foot doors	FINISHES: AL - 204-Ri Clear Arch. Class II anodized coating, AA-M12C22A31 (Std.) BZ - 313-Ri Dark Bronze Arch. Class II anodized coating, AA-M12C22A32	
OPTIONS	45.5" Device for 42" doors 52" Device for 48" doors Custom lengths 26" to 52" Special lengths shorter than 26" Special lengths longer than 52" DEEP (Required on doors with reveals over 11") FLAT (Substitute Flat Arm, provides 1 3/4" of additional head room at top of door)		N/C N/C Add \$75.00 Contact Factory Contact Factory Add \$50.00 Add \$50.00
	104792	4 1/2" Square Button Wireless Single Door Kit	Add \$484.00
	104791-2	4 1/2" Square Button Hardwired Single Door Kit	Add \$349.00



104792 Wireless Kit



104791-2 Hardwired Kit

AO19 SERIES®

LOW ENERGY AUTOMATIC DOOR OPERATORS FOR DOUBLE DOOR APPLICATIONS

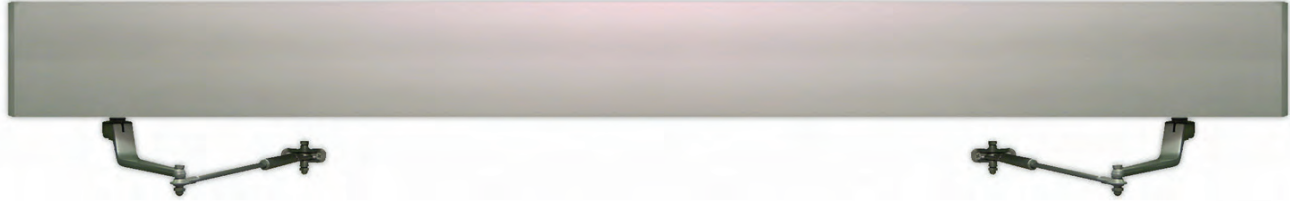

Model Number	Description	Finish	
		Clear (xAL)	Bronze (xBZ)
AO19-2 Push	Double Door Push	\$6,420.00	\$6,420.00
AO19-2 Pull	Double Door Pull	\$6,420.00	\$6,420.00
DEVICE COMES STANDARD WITH:	AL - Clear Finish 75.5" Device for pairs of 3 foot doors	FINISHES: AL - 204-Ri Clear Arch. Class II anodized coating, AA-M12C22A31 (Std.) BZ - 313-Ri Dark Bronze Arch. Class II anodized coating, AA-M12C22A32	
OPTIONS	92" Device for pairs of 44" doors 100" Device for pairs of 48" doors Custom lengths 60" to 100" Special lengths shorter than 60" Special lengths longer than 100" DEEP (Required on doors with reveals over 11") FLAT (Substitute Flat Arm, provides 1 3/4" of additional head room at top of door) Independent (Allows each door to operate independently)		N/C N/C Add \$75.00 Contact Factory Contact Factory Add \$100.00 Add \$100.00 Add \$50.00
	104792 4 1/2" Square Button Wireless Single Door Kit		Add \$484.00
	104791-2 4 1/2" Square Button Hardwired Single Door Kit		Add \$349.00



104792 Wireless Kit



104791-2 Hardwired Kit

AO19 SERIES®

LOW ENERGY AUTOMATIC DOOR OPERATORS FOR DOUBLE EGRESS DOOR APPLICATIONS



Model Number	Description	Finish	
		Clear (xAL)	Bronze (xBZ)
AO19-3xRH Push	Double Egress Doors RH Push / RH Pull	\$6,420.00	\$6,420.00
AO19-3xLH Push	Double Egress Doors LH Push / LH Pull	\$6,420.00	\$6,420.00
DEVICE COMES STANDARD WITH:	AL - Clear Finish 75.5" Device for pairs of 3 foot doors	FINISHES: AL - 204-Ri Clear Arch. Class II anodized coating, AA-M12C22A31 (Std.) BZ - 313-Ri Dark Bronze Arch. Class II anodized coating, AA-M12C22A32	
OPTIONS	92" Device for pairs of 44" double egress doors 100" Device for pairs of 48" double egress doors Custom lengths 60" to 100" Special lengths shorter than 60" Special lengths longer than 100" DEEP (Required on doors with reveals over 11") FLAT (Substitute Flat Arm, provides 1 3/4" of additional head room at top of door) Independent (Allows each door to operate independently)		N/C N/C Add \$75.00 Contact Factory Contact Factory Add \$100.00 Add \$100.00 Add \$50.00
	104792	4 1/2" Square Button Wireless Single Door Kit	Add \$484.00
	104791-2	4 1/2" Square Button Hardwired Single Door Kit	Add \$349.00





104792 Wireless Kit



104791-2 Hardwired Kit

Single Door Kits

	Part Number	Description	Price
	104792	4 1/2" Square Button Wireless Single Door Kit - Includes (2) 4 1/2" Square HSS-Detex Pushplate Switch (104755) (2) Wall Mount Boxes / Transmitter (104753) (1) Multi-Mode Receiver (104752)	\$484.00
	104791-2	4 1/2" Square Button Hardwire Single Door Kit - Includes (2) 4 1/2" Square HSS-Detex Pushplate Switch (104755) (2) 4 1/2" Square Low Profile Mounting Box (104738-1020)	\$349.00
	105372-X	6" Round Button Wireless Single Door Kit - Includes (2) 6" Round Pushplate Switch (104743-X*) (2) Wall Mount Box With Transmitter (104753-R6) (1) Multi-Mode Receiver (104752) **Shown with 104743-H. Also available in -HSS and -P (see legend below)	\$530.00

* Select pushplate switch type (See below for more information)

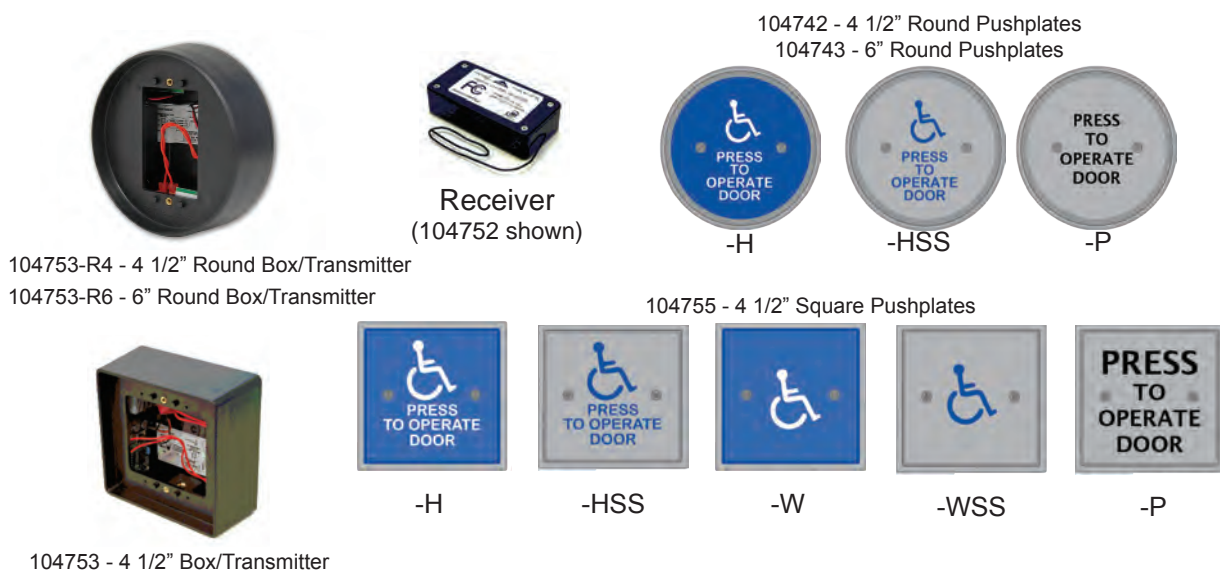

PARTS/ACCESSORIES CONT'D ON PAGE 79

Single Door Itemized Packages

Part Number	Qty.	Description	Price	
104742-X*	2	<u>4 1/2" Round Button Hardwire Single Door Package</u> - Requires 4 1/2" Round Pushplate	2 @ \$102.00 ea	
104738-1025	2		4 1/2" Round Mounting Box	2 @ \$54.00 ea
104755-X*	1	<u>4 1/2" Square Button Hardwire Single Door Package</u> - Requires 4 1/2" Square Pushplate	1 @ \$117.00	
104738-1020	1		4 1/2" Square Low Profile Mounting Box	1 @ \$54.00
104742-X*	2	<u>4 1/2" Round Button Wireless Single Door Package</u> - Requires 4 1/2" Round Pushplate Switch	2 @ \$102.00 ea	
104753-R4	2		Wall Mount Box with Transmitter	2 @ \$156.00 ea
104752	1		Multi-Mode Receiver	1 @ \$165.00
104743-X*	2	<u>6" Round Button Hardwire Single Door Package</u> - Requires 6" Round Pushplate Switch	2 @ \$134.00 ea	
104738-1030	2		6" Round Mounting Box	2 @ \$54.00 ea

* Select pushplate switch type (See below for more information)



104753-R4 - 4 1/2" Round Box/Transmitter
104753-R6 - 6" Round Box/Transmitter



Receiver
(104752 shown)

104742 - 4 1/2" Round Pushplates
104743 - 6" Round Pushplates



104753 - 4 1/2" Box/Transmitter

104755 - 4 1/2" Square Pushplates



PARTS/ACCESSORIES CONT'D ON PAGE 80

Vestibule Door Kits

Part Number	Qty.	Description	Price
104786-X	1 kit	<u>4 1/2" Square Button Wireless Vestibule Kit</u> - Includes (2) 4 1/2" Square Pushplate Switch (104755-X*) (2) Wall Mount Box with Transmitter (104753) (1) Double Vestibule Pushplate (104744-X*) (1) Dual Vestibule Button Box / Transmitter (104753-V) (2) Multi-Mode Receiver (104752)	\$954.00
105388-X	1 kit	<u>4 1/2" Square Wireless Vestibule Sequencing Kit</u> - Includes (2) 4 1/2" Square Pushplate Switch (104755-X*) (2) Wall Mount Box/Sequencing Transmitter (104753-STX) (1) Double Vestibule Pushplate (104744-X*) (2) Multi-Mode Receiver (104752)	\$1,100.00
105387-X	1 kit	<u>4 1/2" Square Button Hardwire Vestibule Kit</u> - Includes (2) 4 1/2" Square Pushplate Switch (104755-X*) (1) Double Vestibule Pushplate (104744-X*) (2) Low Profile Mounting Box (104738-1020) (1) Dual Vestibule Button Box (104738-1015)	\$589.00

* Select pushplate switch type (See next page for more information)

Vestibule Door Itemized Packages

Part Number	Qty.	Description	Price
104742-X*	2	<u>4 1/2" Round Button Wireless Vestibule Package</u> - Requires 4 1/2" Round Pushplate Switch Wall Mount Box with Transmitter Vestibule Double Pushplate Dual Vestibule Button Box / Transmitter Multi-Mode Receiver	2 @ \$102.00 ea
104753-R4	2		2 @ \$156.00 ea
104744-X*	1		1 @ \$224.00
104753-V	1		1 @ \$263.00
104752	2		2 @ \$165.00
104743-X*	2	<u>6" Round Button Wireless Vestibule Sequencing Package</u> - Requires 6" Round Pushplate Switch Wall Mount Box / Sequencing Transmitter Double Vestibule Pushplate Dual Vestibule Button Box / Transmitter Multi-Mode Receiver	2 @ \$134.00 ea
104753-STX-R6	2		2 @ \$156.00 ea
104744-X*	1		1 @ \$224.00
104753-V	1		1 @ \$263.00
104752	2		2 @ \$165.00 ea

* Select pushplate switch type (See next page for more information)

PARTS/ACCESSORIES CONT'D ON PAGE 81

Jamb Mount Kits

Part Number	Qty.	Description	Price
104741-X	1 kit	<u>Jamb Button Wireless Single Door Kit</u> - Includes (2) Pushplate Switch (104739-X*) (2) Jamb Mount Box with Transmitter (104753-J) (1) Multi-Mode Receiver (104752)	\$529.00

* Select pushplate switch type (See below for more information)

Jamb Mount Itemized Packages

Part Number	Qty.	Description	Price
104739-X*	1	<u>Jamb Mount Push Button Hardwire Package</u> - Requires Jamb Pushplate Switch	1 @ \$119.00
104738-1010	1	Jamb Box	1 @ \$54.00
104755	1	<u>4 1/2" Square Push Button Wireless Package</u> - Requires 4 1/2" Square Pushplate Switch	1 @ \$117.00
104753	1	Wall Mount Box / Sequencing Transmitter	1 @ \$156.00
104755	1	<u>4 1/2" Square Push Button Wireless Sequencing Package</u> - Requires 4 1/2" Square Pushplate Switch	1 @ \$117.00
104753-STX	1	Wall Mount / Sequencing Transmitter	1 @ \$195.00

* Select pushplate switch type (See below for more information)

104742 - 4 1/2" Round Pushplates
104743 - 6" Round Pushplates

Receiver
(104752 shown)

-H -HSS -P

104744 - Double Vestibule Pushplates

-H -P -HSS

104753-R4 - 4 1/2" Round Box/Transmitter

104753-J Jamb Mount Box/Transmitter

104739 - Jamb Mount Pushplates

-H -P -HSS -W -WSS

PARTS/ACCESSORIES CONT'D ON PAGE 82

AO19 SERIES®

PARTS/ACCESSORIES CONT'D

PART NO.	QTY.	DESCRIPTION	PRICE
Post Kits and Itemized Packages (cont'd.)			
104788-X	1 kit	<u>Single Button Wireless Post Kit</u> - Includes: (1) 4 1/2" Square Pushplate Switch (104755) (1) Post Transmitter (104753-P) (1) Single Button Post (105380-X*) (1) Multi-Mode Receiver	\$1,059.00
<u>Single Button Wireless Sequencing Vestibule Post Package</u> - Requires:			
104755	2	4 1/2" Square Pushplate Switch	2 @ \$117.00 ea
104744-HSS	1	Double Vestibule Pushplate Switch	1 @ \$224.00
104753-V	1	Dual Vestibule Button Box / Transmitter	1 @ \$263.00
104753-STX	1	Wall Mount Box / Sequencing Transmitter	1 @ \$195.00
104753-STX-P	1	Sequencing Post Transmitter	1 @ \$156.00
104752	2	Multi-Mode Receiver	2 @ \$165.00 ea
105380-X*	1	Single Button Post	1 @ \$794.00
<u>Double Button Wireless Vestibule Post Package</u> - Requires:			
104755	4	4 1/2" Square Pushplate	4 @ \$117.00 ea
104744-HSS	1	Double Vestibule Pushplate	1 @ \$224.00
104753-V	1	Dual Vestibule Button Box / Transmitter	1 @ \$263.00
104753	2	Wall Mount Box / Transmitter	2 @ \$156.00 ea
104753-P	2	Post Transmitter	2 @ \$156.00 ea
104752	2	Multi-Mode Receiver	2 @ \$165.00 ea
105396-X*	1	Double Button Post	1 @ \$1,224.00
<u>Double Button Wireless Sequencing Vestibule Post Package</u> - Requires:			
104755	4	4 1/2" Square Pushplate	4 @ \$117.00 ea
104744-HSS	1	Double Vestibule Pushplate	1 @ \$224.00
104753-V	1	Dual Vestibule Button Box / Transmitter	1 @ \$263.00
104753-STX	2	Wall Mount Box / Sequencing Transmitter	2 @ \$195.00 ea
104753-STX-P	2	Sequencing Post Transmitter	2 @ \$156.00 ea
104752	2	Multi-Mode Receiver	2 @ \$165.00 ea
105396-X*	1	Double Button Post	1 @ \$1,224.00
<u>Double Button Hard Wire Vestibule Post Package</u> - Requires:			
104755	4	4 1/2" Square Pushplate	4 @ \$117.00 ea
104744-HSS	1	Double Vestibule Pushplate	1 @ \$224.00
104738-1020	2	4 1/2" Square Low Profile Mounting Box	2 @ \$54.00 ea
105396-X*	1	Double Button Post	1 @ \$1,224.00
104738-1015	1	4 1/2" Square Mounting Box	1 @ \$54.00

* Select post type (See next page for more information)



Receiver
(104752 shown)



104753 - 4 1/2" Box/Transmitter



104753-J Jamb Mount
Box/Transmitter



104755 - 4 1/2" Square Pushplates

104744 - Double Vestibule Pushplates



-H -P -HSS

104739 - Jamb Mount Pushplates



-H -P -HSS -W -WSS

PARTS/ACCESSORIES CONT'D ON PAGE 83

Where Trust Is Built™

DETEX®
Life Safety, Security and Security Assurance

PART NO.	DESCRIPTION	PRICE
Transmitters		
104737-1	Hand Held Transmitter - 1 Button	\$118.00
104737-2	Hand Held Transmitter - 2 Button	\$139.00
	Includes: Transmitter (1), Box (1)	
104753	Clearpath Square 4 1/2" Wall Mount Transmitter	\$156.00
104753-J	Clearpath Jamb Mount Transmitter	\$156.00
104753-P	Clearpath Post Transmitter (Transmitter only)	\$156.00
104753-R4	Clearpath Round 4 1/2" Wall Mount Transmitter	\$156.00
104753-R6	Clearpath Round 6" Wall Mount Transmitter	\$156.00
104753-V	Clearpath Dual Transmitter	\$263.00
104753-STX	Clearpath Square 4 1/2" Sequencing Transmitter	\$195.00
104753-STX-P	Clearpath Sequencing Post Transmitter (Transmitter Only)	\$195.00
104753-STX-R4	Clearpath Round 4 1/2" Wall Mount Sequencing Transmitter	\$195.00
104753-STX-R6	Clearpath Round 6" Wall Mount Sequencing Transmitter	\$195.00
Receivers		
104752	Clearpath Multi-Mode Receiver	\$165.00
104752-RXM	Clearpath Multi-Mode Receiver w/RXM	\$196.00
Boxes		
104738-1010	Low Profile Jamb Box - 1 Box	\$54.00
104738-1035	Surface Mounting Jamb Box 2" dp	\$64.00
104738-1015	Surface Mounting Box 4.5" SQR	\$54.00
104738-1020	Surface Mounting Low Profile Box 4.5" SQR	\$54.00
104738-1025	Surface Mounting Box 4.5" Round	\$54.00
104738-1030	Surface Mounting Box 6" Round	\$54.00
Posts Only - Mounting & Color Options (Requires 4 1/2" Square Pushplate Switch)		
105380-1	Post - Aluminum Concealed (Pushplate switch required)	\$794.00
105380-2	Post - Bronze Concealed (Pushplate switch required)	\$794.00
105380-3	Post - Aluminum Staked (Pushplate switch required)	\$794.00
105380-4	Post - Bronze Staked (Pushplate switch required)	\$794.00
105380-5	Post - Aluminum Exposed (Pushplate switch required)	\$794.00
105380-6	Post - Bronze Exposed (Pushplate switch required)	\$794.00
105396-1	Post - Aluminum Concealed (2 Pushplate switches required)	\$1,224.00
105396-2	Post - Bronze Concealed (2 Pushplate switches required)	\$1,224.00
105396-5	Post - Aluminum Exposed (2 Pushplate switches required)	\$1,224.00
105396-6	Post - Bronze Exposed (2 Pushplate switches required)	\$1,224.00

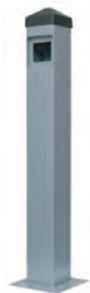

105380-X



105396-X



Receiver
(104752 shown)



104753-R4 - 4 1/2" Round Box/Transmitter
104753-R6 - 6" Round Box/Transmitter



104753-J Jamb Mount Box/Transmitter

PARTS/ACCESSORIES CONT'D ON PAGE 84

PART NO.	DESCRIPTION	PRICE
Pushplate Switches		
104739-P	Includes: Pushplate Switch only Pushplate Switch Jamb 59J-P	\$119.00
104739-HSS	Pushplate Switch Jamb 59J-HSS	\$119.00
104739-WSS	Pushplate Switch Jamb 59J-WSS	\$119.00
104739-W	Pushplate Switch Jamb 59J-W	\$119.00
104739-H	Pushplate Switch Jamb 59J-H	\$119.00
104742-P	Includes: Pushplate Switch only Pushplate Switch 4.5" Round 59R4-P	\$102.00
104742-HSS	Pushplate Switch 4.5" Round 59R4-HSS	\$102.00
104742-WSS	Pushplate Switch 4.5" Round 59R4-WSS	\$102.00
104742-W	Pushplate Switch 4.5" Round 59R4-W	\$102.00
104742-H	Pushplate Switch 4.5" Round 59R4-H	\$102.00
104743-P	Pushplate Switch 6" Round 59R6-P	\$134.00
104743-HSS	Pushplate Switch 6" Round 59R6-HSS	\$134.00
104743-WSS	Pushplate Switch 6" Round 59R6-WSS	\$134.00
104743-W	Pushplate Switch 6" Round 59R6-W	\$134.00
104743-H	Pushplate Switch 6" Round 59R6-H	\$134.00
104744-P	Includes: Double Pushplate Switch (1) Pushplate Switch Vestibule 59V-P	\$224.00
104744-HSS	Pushplate Switch Vestibule 59V-HSS	\$224.00
104744-WSS	Pushplate Switch Vestibule 59V-WSS	\$224.00
104744-W	Pushplate Switch Vestibule 59V-W	\$224.00
104744-H	Pushplate Switch Vestibule 59V-H	\$224.00
104755	Includes: Pushplate Switch only Pushplate Switch 4.5" Square Detex Logo	\$117.00
104755-H	Pushplate Switch 4.5" Square 59-H	\$117.00
104755-HSS	Pushplate Switch 4.5" Square 59-HSS	\$117.00
104755-P	Pushplate Switch 4.5" Square 59-P	\$117.00
104755-W	Pushplate Switch 4.5" Square 59-W	\$117.00
104755-WSS	Pushplate Switch 4.5" Square 59-WSS	\$117.00
105377-1	Switch Red Button Extreme 4.5" SQR	\$156.00
105377-2	Switch Red Button Extreme Narrow	\$156.00

104742 - 4 1/2" Round Pushplates
104743 - 6" Round Pushplates



104744 - Double Vestibule Pushplates

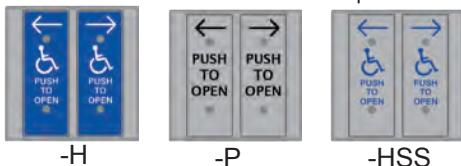

104739 - Jamb Mount Pushplates



104755 - 4 1/2" Square Pushplates



PARTS/ACCESSORIES CONT'D ON PAGE 85

PART NUMBER	DESCRIPTION	PRICE
Keyswitches		
	Includes: Keyswitch (1), Pushplate Switch (1)	
CS4730-P	Cylinder Keyswitch DPDT Momentary P	\$309.00
CS4740-P	Cylinder Keyswitch DPDT Maintained P	\$309.00
CS4730-HSS	Cylinder Keyswitch DPDT Momentary HSS	\$309.00
CS4740-HSS	Cylinder Keyswitch DPDT Maintained HSS	\$309.00
CS4730-H	Cylinder Keyswitch DPDT Momentary H	\$309.00
CS4740-H	Cylinder Keyswitch DPDT Maintained H	\$309.00
Includes: Keyswitch (1)		
105369-1	Keyswitch DPDT Maintained w/4.5" Face Plate	\$197.00
105369-2	Keyswitch DPDT Momentary w/4.5" Face Plate	\$197.00
105369-3	Keyswitch DPDT Maintained w/Narrow Face Plate	\$197.00
105369-4	Keyswitch DPDT Momentary w/Narrow Face Plate	\$197.00
105369-5	Keyswitch DPDT Maintained w/Single Gang Face Plate	\$197.00
105369-6	Keyswitch DPDT Momentary w/Single Gang Face Plate	\$197.00
Miscellaneous		
104790	Safety Presence Sensor (DH97)	\$596.00
105395-1	SafePath SSS-1L1 door mounted Safety Sensor	\$796.00
105395-2	SafePath SSS-1L2 door mounted Safety Sensor	\$896.00
105375-1	Rain Cover for DH Series	\$79.00
105378-1	Safety Beam Surface Mount	\$244.00
104758-1	Microwave Motion Sensor (Microstar)	\$434.00
104787	Door Safety Decal English	\$24.00
104787-1	Door Safety Decal English/Spanish	\$37.00
104747	Universal Time Delay Module (TDM)	\$184.00
104746	Infrared Motion Detector (DH100)	\$555.00
Service & Repair		
104798-1	3-Point Push Arm Assembly AL	\$200.00
104798-2	3-Point Push Arm Assembly BZ	\$200.00
104797-1	Parallel Arm Pull Assembly AL	\$249.00
104797-2	Parallel Arm Pull Assembly BZ	\$249.00
104796-1	Motor / Gearbox LH Push	\$1,198.00
104796-2	Motor / Gearbox LH Pull AL	\$1,198.00
104796-3	Motor / Gearbox RH Push	\$1,198.00
104796-4	Motor / Gearbox RH Pull AL	\$1,198.00
104796-5	Motor / Gearbox LH Pull BZ	\$1,198.00
104796-6	Motor / Gearbox RH Pull BZ	\$1,198.00
104708	Microswitch Harness	\$69.00
104794	3-Position Switch & Wire	\$84.00
105421	Universal Controller	\$759.00
105423	Cable ISP Synchronization	\$139.00
104764-1	Kit 120VAC Line Filter 8 foot	\$290.00
104764-2	Kit 120VAC Line Filter 4 foot	\$240.00
104764-3	Kit 120VAC Line Filter 2 foot	\$240.00
105412	Push - Motor Gear Box Rebuild Kit	\$354.00
105412-1	Pull - Motor Gear Box Rebuild Kit	\$354.00

NOTES

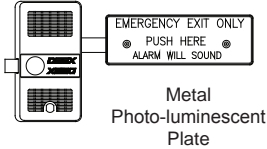
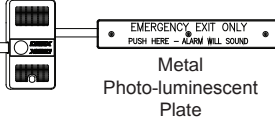
 <p>Metal Photo-luminescent Plate</p>	MODEL NO.	DESCRIPTION	PRICE
	ECL-230D	UL Listed Panic Hardware Exit Control Lock	\$350.00
 <p>Metal Photo-luminescent Plate</p> <p>NOTE: ECL-230D-PH for use on doors that require Panic Hardware</p>	ECL-230D-PH	UL Listed Panic Hardware Standard Exit Control Lock w/Long Bar 36" to 48" Door Width	\$393.00
	<p>Supplied with: 9 volt battery, cover lock w/2 keys, ECL-437 & ECL-439 Keepers Available in Gray or Black English paddle bar plate (ECL-8220 w/ECL-230D or ECL-2109 w/ECL-230D-PH) Shipped less rim cylinder - Rim cylinder available at additional cost (see page 96) Foreign language paddle bar plates available (see page 89)</p>		

FIRE RATED HARDWARE

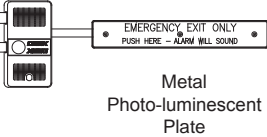

ECL-600

 <p>Metal Photo-luminescent Plate</p>	MODEL NO.	DESCRIPTION	PRICE
	ECL-600	Warnock Hersey Listed Fire Exit Hardware w/Long Bar 36" to 48" Door Width	\$627.00
<p>3 Hour Listing - Single Door to 4' x 8' - Double Doors to 8' x 8' Supplied with: 9 volt battery, cover lock w/2 keys Available in Gray or Black Keeper & strike kit English paddle bar plate - ECL-2109 Shipped less control cylinders Rim cylinders available at additional cost (see page 96)</p>			

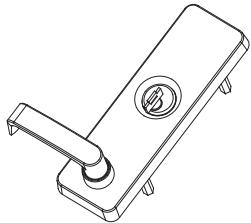
ECL-620 Outside Lever Trim for ECL-600

	MODEL NO.	DESCRIPTION	PRICE
	ECL-620	Outside Lever Trim Lever retracts latch bolt only Rim Cylinder (not included) operates dead bolt Finish: Black only Field Reversible	\$300.00

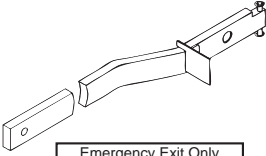
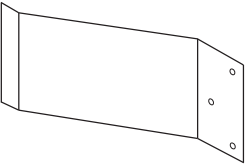
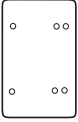
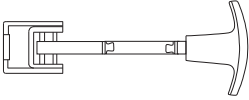
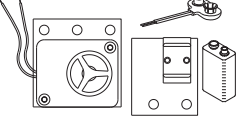
ECL ACCESSORIES



	MODEL NO.	DESCRIPTION	PRICE
 <p data-bbox="170 495 354 548">Emergency Exit Only Alarm Will Sound Push Here</p>	ECL-2105K	Field Conversion Kit For 36" to 48" Door Width with metal Photo-luminescent plate	\$74.00
	ECL-436K	Bar Guard Kit (For use with Standard ECL-230D)	\$24.00
	ECL-2100K	Bar Guard Kit (For use with ECL-230D-PH & ECL-600)	\$35.00
	ECL-475K	Decorative Back Plate Kit	\$38.00
	ECL-498K	Outside Pull and Warning Sign (Not for use on Fire Rated Doors)	\$92.00
	ECL-2111K	6V-to-9V Conversion Kit (For use with ECL-230D and ECL-230C models only)	\$59.00
	PP-5572	Replacement Cover Lock & 2 Keys	\$7.00
	ECL-405-X	Cover Lock Key X = specify Key # 11-20	\$2.00

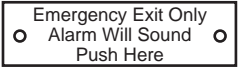
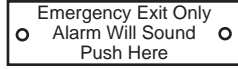

ACCESSORIES CONT'D

 <p>(Metal Photo-Luminescent Plate)</p>	<p>ECL-8220 (RWE)</p> <p>ECL-2109</p>	<p>ECL-230D Metal Exit Bar Plates Specify: English</p> <p>ECL-230D-PH and ECL-600 Metal Exit Bar Plates Specify: English</p>	<p>\$17.00</p> <p>\$24.00</p>
	<p>ECL-8225-8 (RWS) ECL-8225-5 (RWI) ECL-8225-6 (RWC) ECL-8225-9 (GWC) ECL-8225-7 (RWF) ECL-8225-1 (RWD) ECL-8225-2 (GWF) ECL-8225-3 (RWG)</p> <p>101248-1 101248-2 101248-3</p>	<p>ECL-230D Exit Bar Plates Specify: Spanish Italian Chinese (Red) Chinese (Green) French Canadian Dutch French German</p> <p>ECL-230D-PH and ECL-600 Exit Bar Plates Specify: French Canadian Chinese (Red) Chinese (Green) for PH</p>	<p>\$18.00 \$18.00 \$18.00 \$18.00 \$18.00 \$18.00 \$18.00 \$18.00</p> <p>\$59.00 \$59.00 \$59.00</p>

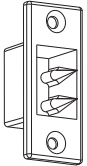
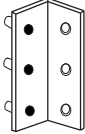
Keeper and Strike Kits - ECL-230D

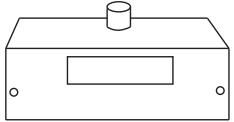
	MODEL NO.	DESCRIPTION	PRICE
	ECL-439K	Mortise Strike Plate Kit	\$8.00
	ECL-435K	Adjustable Surface Keeper "L" & "Z" bracket for double door applications	\$18.00
	ECL-437K	Adjustable Surface (standard)	\$10.00
All Strikes Non-Handed			
	MODEL NO.	DESCRIPTION	PRICE
	DDH-2250	Double Door Holder (ECL-230 Series and V40 Series)	\$113.00



Vertical Rod Assemblies

For Use With ECL-230D Only

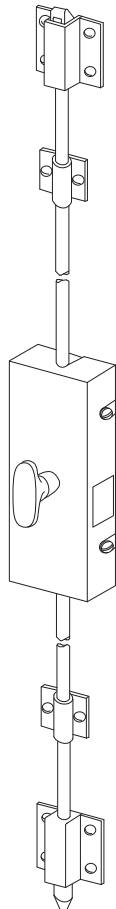
 	MODEL NO.	DESCRIPTION	PRICE
	VRA-143 (B) 84" Standard	Application: Active Leaf Opens Both Doors Includes one Vertical Rod Assembly for active leaf and two overlapping plates for inactive leaf	\$451.00
	VRA-143 (C) 84" Standard	Application: Active leaf opens first; Inactive leaf remains locked until ECL-230D is activated Includes one Vertical Rod Assembly for inactive leaf	\$451.00
	VRA-143 (D) 84" Standard	Application: Each Leaf Independent Includes two Vertical Rod Assemblies, one for each leaf	\$844.00
	Installation Type B	Special Heights over 84" to 96"	\$558.00
	Installation Type C		\$558.00
	Installation Type D		\$1,103.00
	Installation Type B	Over 96"	\$595.00
	Installation Type C		\$595.00
	Installation Type D		\$1,158.00
ECL-230D Exit Control Lock device sold separately. Specify actual door opening height up to 120". Specify type of installation to be made - B, C, or D. Note: VRA-143B can also be used for a single door application to provide 2-point latching.			

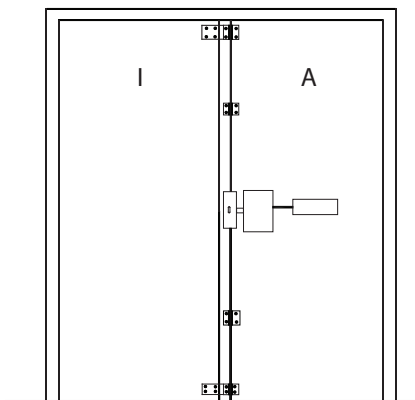

B

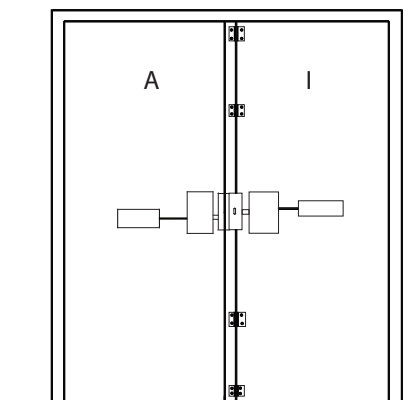

C

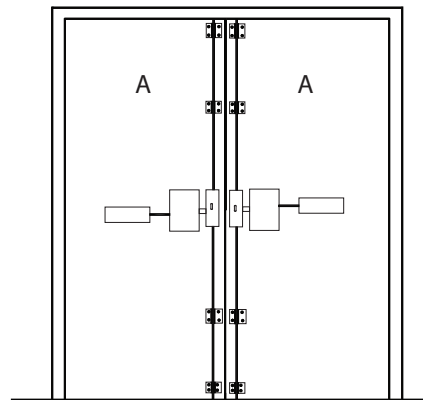



D



ECL-230X SERIES

Alarmed Dead Bolt Panic Hardware

Single Point Lock

 <p>Photo-luminescent Push Plate Sign</p> <p>Hurricane Rating Now Available</p> <p>UL Listed Panic Hardware</p>	MODEL NO.	DESCRIPTION	PRICE
	ECL-230X	Single Point Deadbolt only Exit Control Lock	\$533.00
	ECL-230X-W	 Single Point Deadbolt only Weatherized Exit Control Lock	\$729.00
	Supplied with: 9 volt battery; Optional 9VDC Power Supply see BE-961 Fits 36" - 48" Door (Standard) Available in Gray (Standard) English Push Plate Sign (RWE Standard) or Spanish Push Plate Sign (RWS Option) Other languages available - Call Factory Shipped less rim cylinder - Rim cylinder available at additional cost (see below)		

OPTIONS - ECL-230X

MODEL NO.	DESCRIPTION	PRICE
H	Hurricane Rated Comes standard with SN1 (Sex Nut Kit)	Add \$262.00
DX1 DX2 DX3	Adds one hinge side locking point with mounting hardware Adds two hinge side locking points with mounting hardware Adds three hinge side locking points with mounting hardware DX Bolts available in Gray (Std.) or Black - Specify Finish	\$44.00 \$85.00 \$119.00
30"	Fits 30" wide Door	\$75.00
C65	Rim Cylinder, Schlage "C" Keyway with 2 keys Installed in Lock and / or Trim	\$60.00
IC7	Interchangeable Core Rim Cylinder Housing, Small Format Installed in Lock and / or Trim (Core not Included)	\$60.00
IP	Inside Pull	\$34.00
DDSK	Double Door Strike Kit	\$80.00
CL SS CL-SS	Cover Lock & 2 Keys (Installed) Security Screws Cover Lock & Security Screws	\$20.00 \$21.00 \$41.00
SN1	Sex Nut Kit (included with Hurricane Rated)	\$14.00 (per kit)
RK	ECL-230D RetroFit Kit (Endcap plate and lock-body plate)	\$32.00

NOTE: All cylinders are keyed different. Keyed alike is available upon request.



ECL-230X-TD / ECL-230X-TB SERIES

Alarmed Dead Bolt Panic Hardware 2 Point Locks

	MODEL NO.	DESCRIPTION	PRICE
	ECL-230X-TD	2 Point Top Bolt and Deadbolt Exit Control Lock	\$884.00
	ECL-230X-TB	2 Point Top and Bottom Bolt Exit Control Lock (Cover Lock standard on TB configuration)	\$1,030.00
	 ECL-230X-W-TD	2 Point Top Bolt and Deadbolt / Weatherized Exit Control Lock	\$1,092.00
ECL-230X-W-TB	2 Point Top and Bottom Bolt / Weatherized Exit Control Lock (Cover Lock standard on TB configuration)	\$1,230.00	
Supplied with: 9 volt battery; Optional 9VDC Power Supply see BE-961 Fits 36" - 48" Door (Standard) Available in Gray (Standard) English Push Plate Sign (RWE Standard) or Spanish Push Plate Sign (RWS Option) Other languages available - Call Factory Shipped less rim cylinder - Rim cylinder available at additional cost (see below)			

OPTIONS - ECL-230X

MODEL NO.	DESCRIPTION	PRICE
DX1 DX2 DX3	Adds one hinge side locking point with mounting hardware Adds two hinge side locking points with mounting hardware Adds three hinge side locking points with mounting hardware DX Bolts available in Gray (Std.) or Black - Specify Finish	\$44.00 \$85.00 \$119.00
30"	Fits 30" wide Door	\$75.00
C65 IC7	Rim Cylinder, Schlage "C" Keyway with 2 keys Installed in Lock and / or Trim Interchangeable Core Rim Cylinder Housing, Small Format Installed in Lock and / or Trim (Core not Included)	\$60.00
84" 96" 120"	Fits 6'8" to 7' Door Fits 7' to 8' Door Fits 8' to 10' Door	N/C N/C \$50.00
RC BG RC-BG	Rod Covers Bottom Bolt Guard Rod Covers & Bottom Bolt Guard	\$190.00 \$110.00 \$300.00
IP	Inside Pull	\$34.00
DDSK 96B	Double Door Strike Kit Dust Proof Strike	\$80.00 \$42.00
CL SS CL-SS	Cover Lock & 2 Keys (Installed) (Standard on TB configuration - N/C) Security Screws Cover Lock & Security Screws	\$20.00 \$21.00 \$41.00
SN1	Sex Nut Kit	\$14.00 (per kit)
RK	ECL-230D RetroFit Kit (Endcap plate and lock-body plate)	\$32.00



NOTE: All cylinders are keyed different. Keyed alike is available upon request.



ECL-230X-TDB SERIES

Alarmed Dead Bolt Panic Hardware

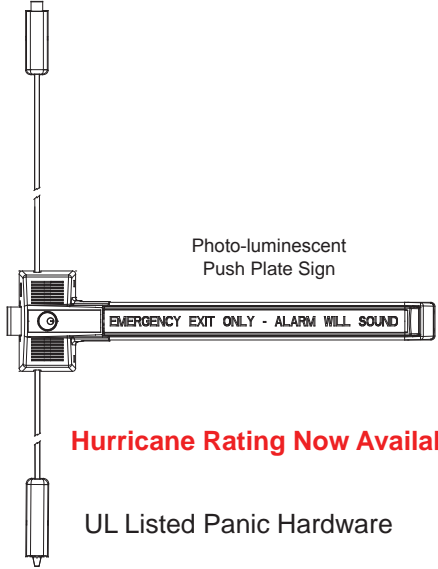
3 Point Lock

 <p>Photo-luminescent Push Plate Sign</p> <p>EMERGENCY EXIT ONLY - ALARM WILL SOUND</p> <p>Hurricane Rating Now Available</p> <p>UL Listed Panic Hardware</p>	MODEL NO.	DESCRIPTION	PRICE
	ECL-230X-TDB	3 Point Top Bolt, Deadbolt and Bottom Bolt Exit Control Lock	\$1,130.00
	ECL-230X-W-TDB	 3 Point Top Bolt, Deadbolt and Bottom Bolt Weatherized Exit Control Lock	\$1,330.00
	Supplied with: 9 volt battery; Optional 9VDC Power Supply see BE-961 Fits 36" - 48" Door (Standard) Available in Gray (Standard) English Push Plate Sign (RWE Standard) or Spanish Push Plate Sign (RWS Option) Other languages available - Call Factory Shipped less rim cylinder - Rim cylinder available at additional cost (see below)		

OPTIONS - ECL-230X

MODEL NO.	DESCRIPTION	PRICE
H	Hurricane Rated	Add \$262.00
	Comes standard with SN1 (Sex Nut Kit)	
DX1	Adds one hinge side locking point with mounting hardware	\$44.00
DX2	Adds two hinge side locking points with mounting hardware	\$85.00
DX3	Adds three hinge side locking points with mounting hardware	\$119.00
	DX Bolts available in Gray (Std.) or Black - Specify Finish	
30"	Fits 30" wide Door	\$75.00
C65	Rim Cylinder, Schlage "C" Keyway with 2 keys Installed in Lock and / or Trim	\$60.00
IC7	Interchangeable Core Rim Cylinder Housing, Small Format Installed in Lock and / or Trim (Core not Included)	
84"	Fits 6'8" to 7' Door	N/C
96"	Fits 7' to 8' Door	N/C
120"	Fits 8' to 10' Door	\$50.00
RC	Rod Covers	\$190.00
BG	Bottom Bolt Guard	\$110.00
RC-BG	Rod Covers & Bottom Bolt Guard	\$300.00
IP	Inside Pull	\$34.00
DDSK	Double Door Strike Kit	\$80.00
96B	Dust Proof Strike	\$42.00
96B-DDS	Dust Proof Strike & Double Door Strike	\$123.00
CL	Cover Lock & 2 Keys (Installed)	\$20.00
SS	Security Screws	\$21.00
CL-SS	Cover Lock & Security Screws	\$41.00
SN1	Sex Nut Kit (included with Hurricane Rated)	\$14.00 (per kit)
RK	ECL-230D RetroFit Kit (Endcap plate and lock-body plate)	\$32.00



NOTE: All cylinders are keyed different. Keyed alike is available upon request.

Where Trust is Built™

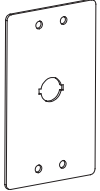

ECL ACCESSORIES

ECL-230X Trim

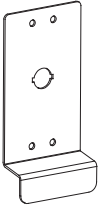
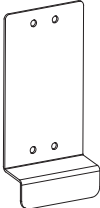
	MODEL NO.	DESCRIPTION	PRICE
	03T	Trim Plate with OKC	\$155.00
	01T	Trim Plate without OKC	\$155.00
	03PP	Pull Plate with OKC	\$155.00
	01PP	Pull Plate without OKC	\$155.00

DX Bolts

	MODEL NO.	DESCRIPTION	PRICE
	DX1	1 Bolt and Through Bolt Mounting Hardware Available in Gray (Std.) or Black - Specify Finish	\$44.00
	DX2	2 Bolts and Through Bolt Mounting Hardware Available in Gray (Std.) or Black - Specify Finish	\$85.00
	DX3	3 Bolts and Through Bolt Mounting Hardware Available in Gray (Std.) or Black - Specify Finish	\$119.00

MODEL NO.	DESCRIPTION	PRICE
GTPL230X	Adjustable Gate Plate - Fits Single Gates 32" - 52" wide Fits square or round gate frames - Does not come with Mounting or Lockbox Holes	\$400.00
03GS	Optional 03 function cylinder trim used on gates (Rim Cylinder sold separately)	\$94.00
GTSTKBKT	Strike Latch Receiver Bracket	\$152.00
GTPLGRD	Gate Latch Protector	\$99.00

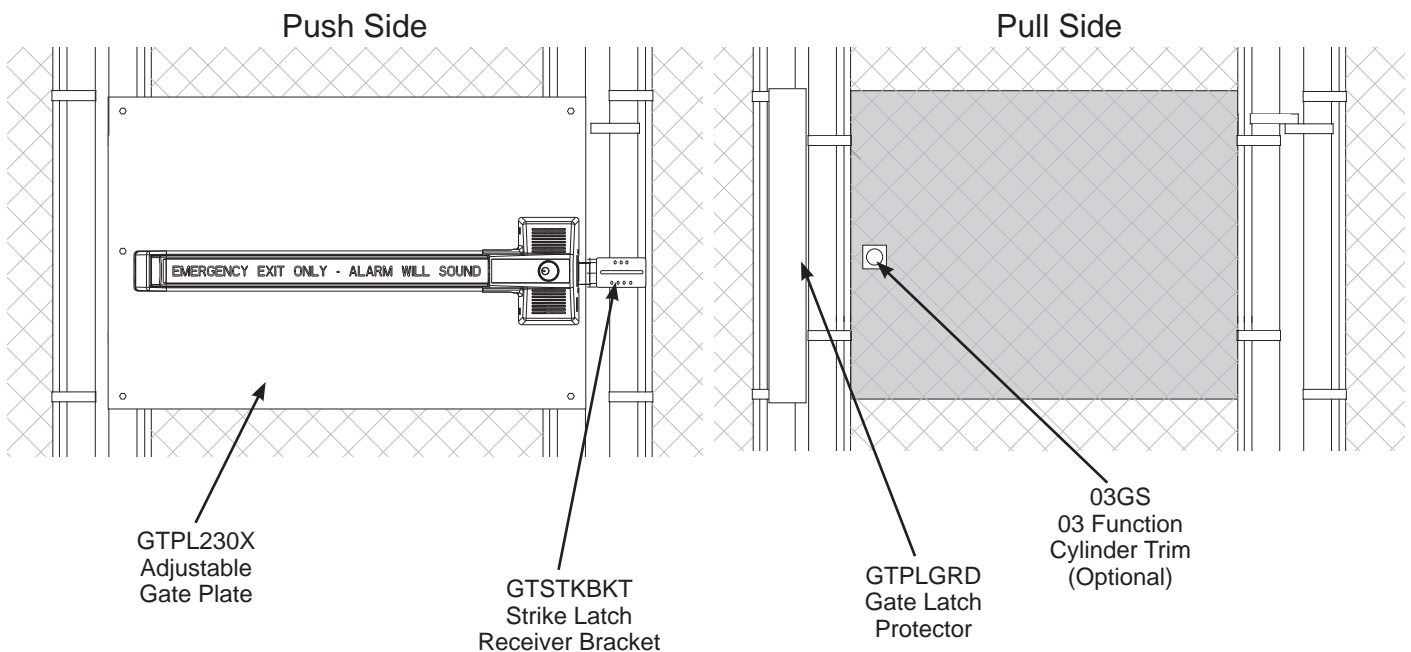

EXIT DEVICE SOLD SEPARATELY

For more information, see Exit Control Locks weatherized exit devices



Cylinders and Accessories

MODEL NO.	DESCRIPTION	PRICE
RC65 (Also known as -ECL-445K) 	Rim Cylinder, Schlage "C" Keyway with 2 keys	\$30.00
MC65 	Mortise Cylinder, Schlage "C" Keyway, 626 Brushed Chrome Finish with 2 keys	\$30.00
IC7 	Interchangeable Core Mortise Cylinder Housing, Small Format (Core not included)	\$30.00
IC7R 	Interchangeable Core Rim Cylinder Housing, Small Format (Core not included)	\$30.00
ECL-470	Extra key for RC65 or MC65 (Specify Key #)	\$8.00
ECL-1595	Standard Cylinder Collars for use with ECL-230 Series & ECL-620	\$4.00
CCS	Short Cylinder Collar (7/16") accommodates most 5- and 6-pin mortise cylinders	\$30.00
CCL	Long Cylinder Collar (11/16") for most 7-pin and 6-and 7-pin interchangeable core cylinders Brushed Chrome Finish	\$30.00
103789 	Cylinder Nut Socket	\$29.00
100783 	Cylinder Nut	\$3.00
NOTE: All cylinders are keyed different. Keyed alike is available upon request.		

NOTES



500 Series Battery Powered Exit Alarm

	MODEL NO.	DESCRIPTION	PRICE
 <p>Mortise Cylinder Sold Separately</p>	EAX-500	Surface Mount Battery Alarm (Sensor Kit & EA-561 Warning Sign Included) Gray Finish - standard	\$228.00
	EAX-500SK1	Kit Includes 1 EAX-500 alarm and: (1) MS-1039S Magnetic Switch (2) MS-1039S Magnetic Switches (1) MS-1059S Magnetic Switch (2) MS-1059S Magnetic Switches (1) MS-2049S Magnetic Switch (2) MS-2049S Magnetic Switches	Add \$48.00
	EAX-500SK2		Add \$96.00
	EAX-500SK3		Add \$48.00
	EAX-500SK4		Add \$96.00
	EAX-500SK5		Add \$85.00
EAX-500SK6	Add \$170.00		
	EAX-500W	Weatherized Surface Mount Battery Alarm	\$344.00
	EAX-500 Series is UL Classified Miscellaneous Fire Door Accessories		

CONFIGURABLE OPTIONS - EAX®-500

MODEL NO.	DESCRIPTION	PRICE
BK	Suffix for black finish	No Additional Cost
EA-561 EA-704-2 102651-1 EA-705 EA-561G 102651-3 102651-2	Self-Adhesive Door Signs English - Red (RWE) Spanish - Red (RWS) French - Green (GWF) French Canadian - Red (RWF) German - Green (RWG) Chinese - Red (RWC) English/German - Green (GWE)	No Additional Cost when ordered with EAX
MC65	Mortise Cylinder, factory installed	Add \$60.00
IC7	7-pin IC Cylinder Housing (Core not included), factory installed	Add \$60.00
KS	Key Stop, factory installed	Add \$5.00
L11 thru L20	Cover lock with specific key number (EAX-500 only)	No Additional Cost
102644	In-Swing Door Kit	Add \$17.00

Arming Delay
 0 = 15 second Arming Delay
 1 = 1 second Arming Delay
 2 = 5 second Arming Delay

EAX-5 0 0 x Enhancements x See further options above

Extended Bypass
 0 = Alarm must be manually turned off; or may be field selected for 2 min. Auto Re-arm
 3 = Alarm must be manually turned off; or may be field selected for 10 min. Auto Re-arm
 4 = Alarm must be manually turned off; or may be field selected for 20 min. Auto Re-arm
Timed Bypass
 5 = Alarm sounds if door is opened after arming delay. Manual Re-arm only

W = Weatherized

For complete how to order information, see www.detex.com/hto

MC65



IC7





NOTE - Cylinders not included. Products on this page can be ordered with cylinders (MC65) or Interchangeable core housings (IC7) pre-installed at Detex prior to shipping (See above).



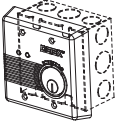

2500 Series AC/DC External Powered Wall Mount Exit Alarm

	MODEL NO.	DESCRIPTION	PRICE
 Mortise Cylinder Not Included	EAX-2500F	Flush Mount AC/DC Powered Alarm Gray Finish - Standard (EA-561 Warning Sign and Back Box Included) Does Not Include, but Requires: Magnetic Door Contacts - See Pg. 103 Transformer - See Pg. 105	\$420.00
	EAX-2500FK	Kit -Flush Mount AC/DC Powered Alarm Gray Finish - Standard (EA-561 Warning Sign, Back Box, flush magnetic switch contact and 24VAC Transformer Included)	\$519.00
 Mortise Cylinder Not Included	EAX-2500S	Surface Mount AC/DC Powered Alarm Gray Finish - Standard (EA-561 Warning Sign and Back Box Included) Does Not Include, but Requires: Magnetic Door Contacts - See Pg. 103 Transformer - See Pg. 105	\$420.00
	EAX-2500SK	Kit - Surface Mount AC/DC Powered Alarm Gray Finish - Standard (EA-561 Warning Sign, Back Box, surface magnetic switch contact and 24VAC Transformer Included)	\$538.00

CONFIGURABLE OPTIONS - EAX®-2500

MODEL NO.	DESCRIPTION	PRICE
BK	Suffix for black finish	No Additional Cost
EA-561 EA-704-2 102651-1 EA-705 EA-561G 102651-3 102651-2	Self-Adhesive Door Signs English - Red (RWE) Spanish - Red (RWS) French - Green (GWF) French Canadian - Red (RWF) German - Green (RWG) Chinese - Red (RWC) English/German - Green (GWE)	No Additional Cost when ordered with EAX
MC65	Mortise Cylinder, factory installed	Add \$60.00
IC7	7-pin IC Cylinder Housing (Core not included), factory installed	Add \$60.00
KS	Key Stop, factory installed	Add \$5.00
C	Conversion kit for retrofit from EA-2500F (102640)	Add \$47.00

Arming Delay

0 = 15 second Arming Delay
1 = 1 second Arming Delay
2 = 5 second Arming Delay

EAX-25 0 0 x See further options above

Extended Bypass

0 = Alarm must be manually turned off; or may be field selected for 2 min. Auto Re-arm
3 = Alarm must be manually turned off; or may be field selected for 10 min. Auto Re-arm
4 = Alarm must be manually turned off; or may be field selected for 20 min. Auto Re-arm

Timed Bypass

5 = Alarm sounds if door is open after arming delay. Manual Re-arm only

For complete how to order information, see www.detex.com/hto

MC65



IC7



NOTE - Cylinders not included. Products on this page can be ordered with cylinders (MC65) or Interchangeable core housings (IC7) pre-installed at Detex prior to shipping (See above).



3500 Series Timed Bypass Exit Alarm and Rechargeable Battery

 Mortise Cylinder Sold Separately	MODEL NO.	DESCRIPTION	PRICE
	EAX-3500	24VAC/DC Hardwired Timed Bypass Exit Alarm with Rechargeable Battery (EA-561 Warning Sign Included) Does not include, but requires: Magnetic Door Contacts - See page 103 24V Transformer - See page 105	\$589.00
	EAX-3500FK	Kit - 24VAC/DC Hardwired Timed Bypass Flush Exit Alarm with Rechargeable Battery, Flush Door Contacts, Plug-in Transformer	\$708.00
	EAX-3500SK	Kit - 24VAC/DC Hardwired Timed Bypass Surface Exit Alarm with Rechargeable Battery, Surface Door Contacts, Plug-in Transformer	\$674.00

CONFIGURABLE OPTIONS - EAX®-3500

MODEL NO.	DESCRIPTION	PRICE
EA-561 EA-704-2 102651-1 EA-705 EA-561G 102651-3 102651-2	Self-Adhesive Door Signs English - Red (RWE) Spanish - Red (RWS) French - Green (GWF) French Canadian - Red (RWF) German - Green (RWG) Chinese - Red (RWC) English/German - Green (GWE)	No Additional Cost when ordered with EAX
MC65	Mortise Cylinder, factory installed	Add \$60.00
IC7	7-pin IC Cylinder Housing (Core not included), factory installed	Add \$60.00

ACCESSORIES - EAX®-3500

MODEL NO.	DESCRIPTION	PRICE
CL-1	Cover Lock Key	\$4.00
BR12	Rechargeable Battery 12VDC, 3.4AH	\$75.00
103945	Allows EAX-3500 Surface Alarm to be recessed into hollow wall construction Kit includes: Flush Box, Instructions and Mounting Hardware	\$89.00

MC65





IC7



NOTE - Cylinders not included. Products on this page can be ordered with cylinders (MC65) or Interchangeable core housings (IC7) pre-installed at Detex prior to shipping (See above).

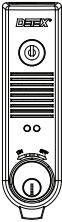

DOOR PROP ALARMS

 <p>Mortise Cylinder Sold Separately</p>	MODEL NO.	DESCRIPTION	PRICE
	EAX-300	Surface Mount Battery Powered 100dB Door Prop Alarm with Internal Magnetic Door Contacts and Back Box Available in: Gray or Black	\$272.00
	EAX-300SK1 EAX-300SK2 EAX-300SK3 EAX-300SK4 EAX-300SK5 EAX-300SK6	Kit Includes 1 EAX-300 alarm and: (1) MS-1039S Magnetic Switch (2) MS-1039S Magnetic Switches (1) MS-1059S Magnetic Switch (2) MS-1059S Magnetic Switches (1) MS-2049S Magnetic Switch (2) MS-2049S Magnetic Switches	Add \$48.00 Add \$96.00 Add \$48.00 Add \$96.00 Add \$85.00 Add \$170.00
	EAX-300W 	Weatherized Door Prop Alarm	\$378.00

CONFIGURABLE OPTIONS - EAX®-300

MODEL NO.	DESCRIPTION	PRICE
BK	Suffix for black finish	No Additional Cost
EA-561 EA-704-2 102651-1 EA-705 EA-561G 102651-4 102651-3 102651-2	Self-Adhesive Door Signs English - Red (RWE) Spanish - Red (RWS) French - Green (GWF) French Canadian - Red (RWF) German - Green (RWG) Chinese - Green (RWG) Chinese - Red (RWC) English/German - Green (GWE)	No Additional Cost when ordered with EAX
MC65	Mortise Cylinder, factory installed	Add \$60.00
IC7	7-pin IC Cylinder Housing (Core not included), factory installed	Add \$60.00
KS	Key Stop, factory installed	Add \$5.00

MODE
 * 0 = Door Prop
 1 = Door Chime
 W = Weatherized - Add \$106

EAX-3 0 0 x Enhancements x See further options above

DOOR PROP DELAY
 * 0 = 15 seconds
 1 = 1 second
 3 = 30 seconds
 5 = 45 seconds
 6 = 60 seconds
 2 = 2 minutes
 4 = 4 minutes 15 seconds

For complete how to order information, see www.detex.com/hto



DOOR PROP ALARMS

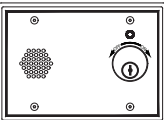



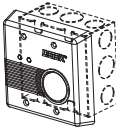
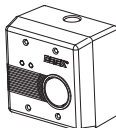
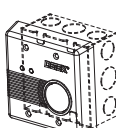
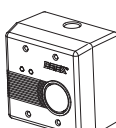

	EAX-411SK	Surface Mount AC/DC 85dB Door Prop Alarm Kit (Back Box, Surface Magnetic Switch Contacts and 24VAC Transformer Included)	\$350.00
	EAX-4200SK	Surface Mount AC/DC 85dB Exit Alarm/ Door Prop Alarm Kit (Back Box, Surface Magnetic Switch Contacts, 24VAC Transformer and rim cylinder Included)	\$839.00



CS SERIES REMOTE ALARMS

	MODEL NO.	DESCRIPTION	PRICE
	CS-940F CS-950F	Flush Mount 9VDC Battery Powered Remote Alarm No cylinder required Available in: Gray or Black	\$159.00
	CS-940S CS-950S	Surface Mount 9VDC Battery Powered Remote Alarm No cylinder required Available in: Gray or Black	\$159.00
	CS-2940F CS-2950F	Flush Mount Externally Powered Remote Alarm with 9 VDC battery backup. AC adapter included - No cylinder required Available in: Gray or Black	\$212.00
	CS-2940S CS-2950S	Surface Mount Externally Powered Remote Alarm with 9 VDC battery backup. AC adapter included - No cylinder required Available in: Gray or Black	\$212.00



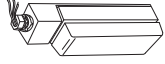
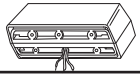

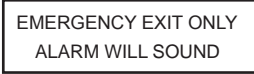
DOOR SWITCHES

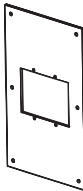
	MODEL NO.	DESCRIPTION	PRICE
	MS-1039F	Economical Magnetic Switch Flush Mount, White, Closed Contacts	\$27.00
	MS-1039S*	Economical, Balanced Magnetic Switch Surface Mount, White, Closed Contacts	\$48.00
	MS-1059F	Economical Magnetic Switch Flush Mount, Brown, Closed Contacts	\$27.00
	MS-1059S*	Economical, Balanced Magnetic Switch Surface Mount, Brown, Closed Contacts	\$48.00
	MS-2049F**	Heavy Duty Form C Magnetic Switch (Flush Mount)	\$66.00
	MS-2049S**	Heavy Duty Form C Magnetic Switch (Surface Mount)	\$85.00
	MS-2049SC**	Heavy Duty Form C Magnetic Switch (Surface/Conduit Mount)	\$147.00
	MS-2049SI	Heavy Duty Form C Magnetic Switch (Surface Inswinging Mount)	\$135.00
<p>* Meets UL 634 Level 2 High Security Sensor Standard ** UL Classified Miscellaneous Fire Door Accessories</p>			

	MODEL NO.	DESCRIPTION	PRICE
	EA-561	Self-Adhesive Door Signs - Pricing for additional Self-Adhesive Door Signs not ordered with EAX	
	EA-704-2	English - Red (RWE)	\$2.00
	102651-1	Spanish - Red (RWS)	\$10.00
	EA-705	French - Green (GWF)	\$10.00
	EA-561G	French Canadian - Red (RWF)	\$10.00
	102651-3	German - Green (RWG)	\$10.00
	102651-2	Chinese - Red (RWC) English/German - Green (GWE)	\$10.00
	102644	In-Swing Door Kit (For use with EAX-500 and EAX-300)	\$17.00
	PP-5572	Replacement Cover Lock & 2 Keys (For use with EAX-500 and EAX-300)	\$7.00
	102640	Conversion Kit for Retrofit from EA-2500F to EAX-2500F Size: 11" x 6.5" x .16" Aluminum Plate Includes: Anchors, Screws and Instructions	\$47.00

POWER SOURCES

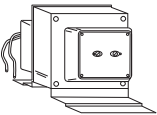
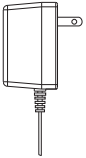
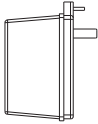
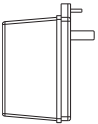
	MODEL NO.	DESCRIPTION	PRICE
	BE-961-1	Battery Eliminator - 120VAC to 9VDC Includes 10' Flex Conduit Powers up to 3 ECLs or 3 V40s	\$259.00
	BE-961-2	Battery Eliminator - Same as above with Supervisory Loop Power, alarm and LED (For use with ECL-230 & ECL-600 Series only)	\$301.00
	BE-961-5	Battery Eliminator - 12VAC to 9VDC Does not include Transformer or Flex Conduit Powers up to 3 ECLs or 3 V40s	\$174.00
	BE-961-6	Battery Eliminator - 24VAC to 9VDC Does not include Transformer or Flex Conduit Powers up to 3 ECLs or 3 V40s	\$174.00
		PP-5567	9V Battery
	PP-5152-2	Transformer, 120VAC - 24VAC 40 VA-60Hz	\$69.00
	PP-5152-3	Transformer, 120VAC - 12VAC 25 VA-60Hz	\$32.00
	PP-5452-2	Transformer, 240VAC - 12VAC, 25VA-50Hz	\$47.00
	277	Transformer, 277VAC TO 24VAC 100VA	\$76.00
	TFMR9	Plug-In Transformer, with wires 120VAC - 9VDC 200mA	\$27.00
	TFMR12	Plug-In Transformer, with terminals 120VAC - 12VDC	\$53.00
	TFMR24	Plug-In Transformer, with terminals 120VAC - 24VAC 20 VA	\$27.00

REDI-KEY KEY VAULTS

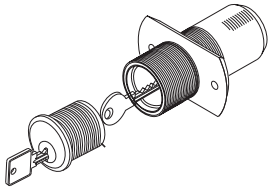
	MODEL NO.	DESCRIPTION	PRICE
	FS-3000-S	Standard Unit - Stainless Steel Key Control System	\$353.00
	Unit furnished with cylinder and two (2) keys on request Call factory for availability on any special keying requirements Two levels of High Security Control available		



NOTES



2000 SERIES ACCESS CONTROL

	MODEL NO.	DESCRIPTION	PRICE
	DTX-2100	Stand-Alone Backlit Keypads NOTE: No software / No audit trail	\$461.00
	DTX-2110	Stand-Alone Keypads Durable Metal Keypad with Braille NOTE: No software / No audit trail	\$619.00
	DTX-2120	Stand-Alone Keypads Mullion Mount Backlit Keypad NOTE: No software / No audit trail	\$767.00
	DTX-2300	Stand-Alone Proximity Reader / Keypad NOTE: No software / No audit trail	\$658.00
Weatherstrip supplied standard with all units.			

DTX-2000 SERIES ACCESSORIES

	MODEL NO.	DESCRIPTION	PRICE
	CARD-125kHz	25-pack of 125kHz proximity access cards for use with the DTX-2300 or DTX-4300 proximity card readers. 26-bit format, facility code 11	\$196.00
	FOB-125kHz	25-pack of 125kHz proximity access key fobs for use with the DTX-2300 or DTX-4300 proximity card readers. 26-bit format, facility code 11	\$429.00

ACCESS CONTROL CONT'D ON PAGE 109

DTX-4000 SERIES HOW TO ORDER

Design
0 = Backlit Hardened Keys *
1 = Metal Braille Keys
2 = Mullion

Mounting
S = Surface

Interface Connection
NDESK = Network (Desktop)
NCAN = Network (Can)
USB = USB Serial





Color
B = Black

DTX-4 Example Order Number **1** **0** **2** **x** **S** **x** **B** **USB**

DEVICE
1 = Keypad
3 = Keypad and Card Reader

SYSTEM (DTX-4XXX)
1 = 1 Door System
2 = 2 Door System
3 = 3 Door System
4 = 4 Door System
5 = 5 Door System
6 = 6 Door System
7 = 7 Door System
8 = 8 Door System
(Specify - Up to 16 door systems)
1M = Single door audit with DTX-4001













* Default if left blank

	MODEL NO.	COMPUTER INTERFACE	DESCRIPTION	PRICE
 (DTX-4111M)	DTX-4111M x USB or NDESK or N2CAN (Network)*	 USB	Access Control System for single door, with (1) DTX-4110 Keypad, (1) DTX-4001 controller with software, and transformer with either USB, Network Desktop mount (NDESK) or Network Can mount (NCAN). Expand system by adding (1 door) DTX-4001 or (4 doors) DTX-4004 controllers and added Keypads. Power for Keypads sold separately	DTX-4111MxUSB \$2,431.00
		 NDESK		DTX-4111MxNDESK \$3,288.00
		 NCAN		DTX-4111MxNCAN \$3,102.00

* See How to Order above
 Weatherstrip supplied standard with all units.

ACCESS CONTROL CONT'D ON PAGE 110













DTX-4000 SERIES ACCESS CONTROL CONT'D

	MODEL NO.	COMPUTER INTERFACE	DESCRIPTION	PRICE
 <p>(DTX-4111)</p>	DTX-4111 x USB or NDESK or NCAN (Network)*	 <p>USB</p>  <p>NDESK</p>  <p>NCAN</p>	<p>Access Control System for single door, with (1) DTX-4110 Keypad, (1) DTX-4004 controller with software, and transformer plus (1) controller module (105904) with either USB, Network Desktop mount (NDESK) or Network Can mount (NCAN). Add up to 3 more doors, by adding (3) keypads & (3) Controller Modules (105904). If adding 4 or more doors, additional DTX-4004 controllers & Keypads required.</p> <p>Power for Keypads sold separately</p>	<p>DTX-4111xUSB \$3,063.00</p> <p>DTX-4111xNDESK \$3,920.00</p> <p>DTX-4111xNCAN \$3,734.00</p>
 <p>(DTX-4123)</p>	DTX-4123 x USB or NDESK or NCAN (Network)*	 <p>USB</p>  <p>NDESK</p>  <p>NCAN</p>	<p>Access Control System for three doors, with (3) DTX-4120 Keypads, (1) DTX-4004 controller with software, and transformer plus (3) controller modules (105904) with either USB, Network Desktop mount (NDESK) or Network Can mount (NCAN). Add up to 1 more door, by adding (1) keypad & (1) Controller Module (105904). If adding 2 or more doors, additional DTX-4004 controller, modules & Keypads required.</p> <p>Power for Keypads sold separately</p>	<p>DTX-4123xUSB \$6,044.00</p> <p>DTX-4123xNDESK \$6,901.00</p> <p>DTX-4123xNCAN \$6,715.00</p>
 <p>(DTX-4303)</p>	DTX-4303 x USB or NDESK or NCAN (Network)*	 <p>USB</p>  <p>NDESK</p>  <p>NCAN</p>	<p>Access Control System for three doors, with (3) DTX-4300 Keypad/cardreaders & software, with either USB, Network Desktop mount (NDESK) or Network Can mount (NCAN). Expand system by simply adding additional DTX-4300 keypad/cardreaders.</p> <p>Power for Keypads sold separately - Access Cards & Fobs sold separately</p>	<p>DTX-4303xUSB \$3,960.00</p> <p>DTX-4303xNDESK \$4,817.00</p> <p>DTX-4303xNCAN \$4,631.00</p>

* See How to Order on Page 109
Weatherstrip supplied standard with all units.

ACCESS CONTROL CONT'D ON PAGE 111

DTX-4000 SERIES ACCESS CONTROL CONT'D







	MODEL NO.	COMPUTER INTERFACE	DESCRIPTION	PRICE
 <p>(DTX-4305)</p>	DTX-4305 x USB or NDESK or NCAN (Network)*	 USB  NDESK  NCAN	Access Control System for five doors, includes (5) DTX-4300 Keypad/cardreaders & software, with either USB, Network Desktop mount (NDESK) or Network Can mount (NCAN). Expand system by simply adding additional DTX-4300 keypad/cardreaders. Power for Keypads sold separately - Access Cards & Fobs sold separately	
			DTX-4305xUSB	\$6,406.00
			DTX-4305xNDESK	\$7,263.00
			DTX-4305xNCAN	\$7,077.00
 <p>(DTX-4119)</p>	DTX-4119 x USB or NDESK or NCAN (Network)*	 USB  NDESK  NCAN	Access Control System for nine doors, includes (9) DTX-4110 Keypads, (3) DTX-4004 Controllers with software and (3) transformers, with either USB, Network Desktop mount (NDESK) or Network Can mount (NCAN). Add up to 3 more doors by adding (3) keypads & (3) 105904 controller modules or add 4 or more doors by adding additional DTX-4004 controllers, modules & keypads. Power for Keypads sold separately	
			DTX-4119xUSB	\$18,063.00
			DTX-4119xNDESK	\$18,920.00
			DTX-4119xNCAN	\$18,734.00
 <p>(DTX-43014)</p>	DTX-43014 x USB or NDESK or NCAN (Network)*	 USB  NDESK  NCAN	Access Control System for fourteen doors, includes (14) DTX-4300 Keypad/cardreaders with software, with either USB, Network Desktop mount (NDESK) or Network Can mount (NCAN). Expand system by simply adding additional DTX-4300 keypad/cardreaders. Power for Keypads sold separately	
			DTX-43014xUSB	\$17,413.00
			DTX-43014xNDESK	\$18,270.00
			DTX-43014xNCAN	\$18,084.00

* See How to Order on Page 109
Weatherstrip supplied standard with all units.

ACCESS CONTROL CONT'D ON PAGE 112



4000 SERIES ACCESSORIES



	MODEL NO.	DESCRIPTION	PRICE
	105904	Plug-In Door Control Module for use with DTX-4004 Secured Series Controller. Plugs directly on to the backplane of the DTX-4004 for expansion for up to three (3) door control modules per DTX-4004.	\$957.00
	105914	USB to Serial Converter on a single-gang electrical plate for use with DTX-4001, DTX-4004 or DTX-4300 controllers. Converts either RS232 or RS485 to USB for direct-connect to laptop or desktop computers.	\$309.00
	105913	TCP/IP to Serial Data Converter enabling DTX-4001 or DTX-4004 controllers to receive data and be programmed using any network workstation running HubManager Professional Software. Easily plugs into backplane of DTX-4001 or DTX-4004 controllers. Requires TCP/IP Ethernet Lan connection.	\$962.00
	105912	TCP/IP to Serial Data Converter enabling DTX-4300 controllers to receive data and be programmed using any network workstation running HubManager Professional Software. Requires TCP/IP Ethernet LAN connection.	\$1,148.00
	CARD125kHz	25-pack of 125kHz proximity access cards for use with the DTX-2300 or DTX-4300 proximity card readers. 26-bit format, facility code 11	\$196.00
	FOB125kHz	25-pack of 125kHz proximity access key fobs for use with the DTX-2300 or DTX-4300 proximity card readers. 26-bit format, facility code 11	\$429.00

TAILGATE DETECTION / ANTI-TAILGATE

	MODEL NO.	DESCRIPTION	PRICE
	AT-5200-RO	Anti-Tailgate without remote alarm	\$4,494.00
	AT-5200-R1	Anti-Tailgate with remote alarm	\$4,594.00



KEYSWITCHES

 <p>CS-450, CS-460, CS-430, CS-440 (No LED, shown with cylinder installed - sold separate)</p>  <p>CS-452, CS-462, CS-432, CS-442 (2 LEDs - red & green, shown with cylinder installed - sold separate)</p>	MODEL NO.	DESCRIPTION	PRICE
	CS450	Keyswitch, single, momentary, no LED	\$176.00
	CS452	Keyswitch, single, momentary, 2 LED's (green - red)	\$176.00
	CS460	Keyswitch, single, maintained, no LED	\$176.00
	CS462	Keyswitch, single, maintained, 2 LED's (green - red)	\$176.00
	CS430	Keyswitch, 2 switches, momentary, no LED	\$176.00
	CS432	Keyswitch, 2 switches, momentary, 2 LED's (green - red)	\$176.00
	CS440	Keyswitch, 2 switches, maintained, no LED	\$176.00
	CS442	Keyswitch, 2 switches, maintained, 2 LED's (green - red)	\$176.00
Note: Single switch back box not included; requires mortise cylinder			

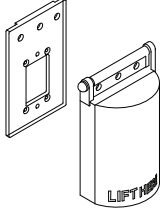

KEYSWITCH COVERS

	MODEL NO.	DESCRIPTION	PRICE
	PC1	Keyswitch Cover & Adapter Plate	\$82.00



MOTION SENSORS

	MODEL NO.	DESCRIPTION	PRICE
	MN01	Motion Detector, 12/24VDC, form C relay	\$253.00
	MN02	Motion Detector, 9-16VDC, form A relay (N.O.)	\$69.00





PUSH BUTTONS

	MODEL NO.	DESCRIPTION	PRICE
	PB-2138-3	Shroud, beige, terminals, form C, single gang	\$359.00
	PB-2158-3	Shroud, aluminum, terminals, form C, mullion mount	\$289.00
	PB-2048-3	Mushroom, aluminum, terminals, form C, single gang	\$329.00
Note: Single switch back box not included			



ELECTRIC STRIKES

	MODEL NO.	DESCRIPTION	PRICE
	DS-1481-630	12/24 V AC/DC, Rim	\$889.00
	DS-1581-LBM	12/24 VDC, Rim, Latch Bolt Monitoring	\$900.00
	DS-1581	12/24 VDC, Rim	\$400.00
	DS-3681-630	Cylindrical Electric Strike	\$396.00

ELECTROMAGNETIC LOCKS

	MODEL NO.	DESCRIPTION	PRICE
	ML-1548	1500 lbs., 12/24 VDC, Surface	\$654.00
	ML-1548RT	1500 lbs., 12/24 VDC, Timer (0-30 seconds)	\$679.00
	ML-1549W	Weatherized	\$624.00
	ML-1549WF	Weatherized, Face Mount	\$624.00

WEATHERIZED HORN/STROBE

	MODEL NO.	DESCRIPTION	PRICE
	HR2	Horn, Red, no lettering, backbox, 2 wire, 12/24 VDC	\$196.00
	SR2	Strobe, red, black lettering, backbox, 2 wire, 12/24 VDC	\$259.00
	HSR2	Horn/Strobe, red, black lettering, backbox, 2 wire, 12/24 VDC	\$296.00
	HSR4	Horn/Strobe, red, black lettering backbox, 4 wire, 12/24 VDC	\$329.00

POWER TRANSFERS / ELECTRIC HINGE

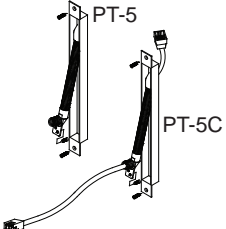
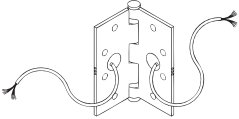
	MODEL NO.	DESCRIPTION	PRICE
	PT-5	Power Transfer - 628 Finish	\$134.00
	PT-5C	Power Transfer with 6-Pin Connector and Insulated Cable	\$229.00
	EWH8-626	4.5" x 4.5" x 8 wire Standard Weight Electric Hinge	\$329.00

REMOTE INDICATING PANELS

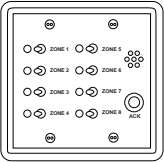
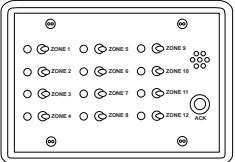
	MODEL NO.	DESCRIPTION	PRICE
	RP-621*	2-Gang Switch Box Wall Mount 8-Zone Annunciator W/Shunt 12V DC	\$669.00
	RP-631*	3-Gang Switch Box Wall Mount 12-Zone Annunciator W/Shunt 12V DC	\$929.00
*Units do not come with Back Box supplied. Fits standard 2- or 3-gang electrical box.			

NEMA ENCLOSURE

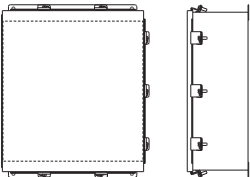
	MODEL NO.	DESCRIPTION	PRICE
	104500	16" x 14" x 6" NEMA 4X Enclosure (sealed enclosure) 304 Stainless Steel	\$1,799.00

One Part Number = One Easy Solution

Easy to Specify, Easy To Order, Easy to Price, Easy to Sell, Easy to Install
Best-in-class products, kitted together for custom solutions to common applications.

Below are several pre-configured EasyKits, however, Detex can create a more custom EasyKit for a specific application. Just contact your local sales representative or email your request to marketing@detex.com. For more information, visit our website at www.detex.com and click on Integrated Door Security Systems.

MODEL NO.	DESCRIPTION	PRICE
ACDx10xS5000x1S-1	<p>Advantex Rim Exit Device with Kaba S5000 Exit Trim for Single Door</p> <p>Kit Includes: (1) Detex 10 Series rim device with hex dogging, brushed stainless finish, for 36" door, surface strike (1) Kaba 5010XSWL62641 S5000 Simplex push button, exit device lever trim, with single common pin user, Schlage C key override, Winston Lever, Satin Chrome</p> 	\$1,870.00
ACDx10xS5000x1S-2	<p>Advantex Rim Exit Device with Kaba S5000 Exit Trim for Single Door</p> <p>Kit Includes: (1) Detex 10 Series rim device with hex dogging, brushed stainless finish, for 36" door, surface strike (1) Kaba 5010BWL62641 S5000 Simplex push button, exit device lever trim, with single common pin user, BEST interchangeable core key override, Winston Lever, Satin Chrome</p> 	\$1,870.00



Contact factory for custom design EasyKits
EasyKits subject to additional restocking fee

ACCESS CONTROL DOOR KITS CONT'D ON PAGE 119

MODEL NO.	DESCRIPTION	PRICE
ACDx10xE5000x1S-1	<p align="center">Advantex Rim Exit Device with Kaba E5000 Exit Trim for Single Door</p> <p>Kit Includes: (1) Detex 10 Series rim device with hex dogging, brushed stainless finish, for 36" door, surface strike (1) Kaba E5010XSWL62641 E5000 E-plex push button, exit device lever trim, with 100 pin users, Schlage C key override, Winston Lever, Satin Chrome</p> <hr/> 	\$2,023.00
ACDx10xE5000x1S-2	<p align="center">Advantex Rim Exit Device with Kaba E5000 Exit Trim for Single Door</p> <p>Kit Includes: (1) Detex 10 Series rim device with hex dogging, brushed stainless finish, for 36" door, surface strike (1) Kaba E5010BWL62641 E5000 E-plex push button, exit device lever trim, with 100 pin users, BEST interchangeable core key override, Winston Lever, Satin Chrome</p> <hr/> 	\$2,023.00

Contact factory for custom design EasyKits
 EasyKits subject to additional restocking fee

ACCESS CONTROL DOOR KITS CONT'D ON PAGE 120

MODEL NO.	DESCRIPTION	PRICE
ACDxV40xS5010x1S-1	<p align="center">Value Series Rim Exit Device with Kaba S5000 Exit Trim for Single Door</p> <p>Kit Includes: (1) Detex Value Series rim device with hex dogging, black pushpad, for 36" door, surface strike (1) Kaba 5010XSWL62641 S5000 Simplex push button, exit device lever trim, with single common pin user, Schlage C key override, Winston Lever, Satin Chrome</p> <hr/> 	\$1,499.00
ACDxV40xS5010x1S-2	<p align="center">Value Series Rim Exit Device with Kaba S5000 Exit Trim for Single Door</p> <p>Kit Includes: (1) Detex Value Series rim device with hex dogging, black pushpad, for 36" door, surface strike (1) Kaba 5010BWL62641 S5000 Simplex push button, exit device lever trim, with single common pin user, BEST interchangeable core key override, Winston Lever, Satin Chrome</p> <hr/> 	\$1,499.00

Contact factory for custom design EasyKits
 EasyKits subject to additional restocking fee

ACCESS CONTROL DOOR KITS CONT'D ON PAGE 121

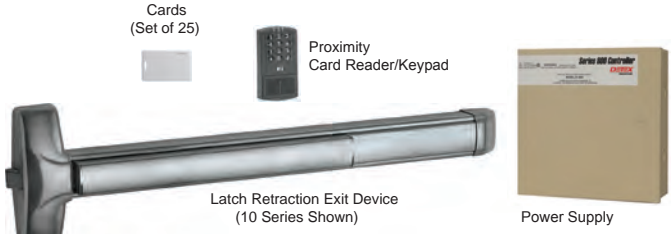
MODEL NO.	DESCRIPTION	PRICE
ACDx10xERx1S-7	<p>Advantex Latch Retraction Rim Exit Device with Detex Access Control System for Single Door</p> <p>Kit Includes:</p> <ul style="list-style-type: none"> (1) Detex 1003CxER, Rim exit latch retraction device with night latch cylinder pull trim with cylinder, brushed stainless finish for a 36" door, and surface strike (1) Detex Latch Retraction Power Supply for single door (1) Detex M12 12 Volt Module (1) DTX-2100 Keypad, Stand-Alone (1) Power Transfer - call ahead for template for door/frame prep (1) Set of Install and wiring instructions 	\$3,999.00
	 <p style="text-align: center;">Latch Retraction Exit Device (10 Series Shown)</p> <p style="text-align: center;">Keypad (Backlit Keypad Shown)</p> <p style="text-align: center;">Power Supply</p>	
ACDx10xERx1S-8	<p>Advantex Latch Retraction Rim Exit Device with Detex Access Control System for Single Door</p> <p>Kit Includes:</p> <ul style="list-style-type: none"> (1) Detex 1003CxER, Rim exit latch retraction device with night latch cylinder pull trim with cylinder, brushed stainless finish for a 36" door, and surface strike (1) Detex Latch Retraction Power Supply for single door (1) Detex M12 12 Volt Module (1) DTX-2300 Proximity Card Reader/Keypad, Stand-Alone (1) Set of Prox Cards (25 pcs.) (1) Power Transfer - call ahead for template for door/frame prep (1) Set of Install and wiring instructions 	\$4,392.00
	 <p style="text-align: center;">Latch Retraction Exit Device (10 Series Shown)</p> <p style="text-align: center;">Cards (Set of 25)</p> <p style="text-align: center;">Proximity Card Reader/Keypad</p> <p style="text-align: center;">Power Supply</p>	

Contact factory for custom design EasyKits
EasyKits subject to additional restocking fee

DELAYED EGRESS DOORS

One Part Number = One Easy Solution

Easy to Specify, Easy To Order, Easy to Price, Easy to Sell, Easy to Install
Best-in-class products, kitted together for custom solutions to common applications.

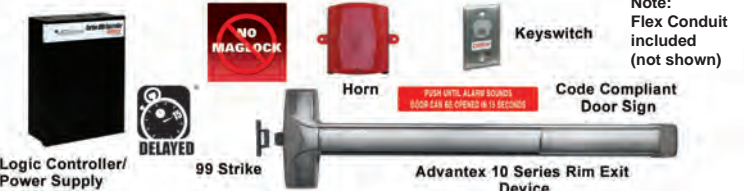

Below are several pre-configured EasyKits, however, Detex can create a more custom EasyKit for a specific application. Just contact your local sales representative or email your request to marketing@detex.com. For more information, visit our website at www.detex.com and click on Integrated Door Security Systems.

MODEL NO.	DESCRIPTION	PRICE
DEx10EEXx1S-1	<p>Advantex Request to Exit Signal Rim Exit Device with Controller and components for Single Door</p> <p>Kit Includes:</p> <ul style="list-style-type: none"> (1) Detex 10 Series device brushed stainless finish, for 36" door, pushpad activates signal switch - surface strike (#99), includes endcap with flexible conduit loop & fittings (1) Controller / Power Supply with wiring diagram (1) HR2 - Horn with adjustable tone settings (1) Keyswitch with momentary switching (Mortise cylinder included) (1) ECL-395 Delayed Egress, Code Compliant Peel & Stick Door Sign  <p>Note: Flex Conduit included (not shown)</p>	\$3,780.00
DEx10EEXx1P-1	<p>Advantex Request to Exit Signal Rim Exit Device with Controller and components for a Pair of Doors</p> <p>Kit Includes:</p> <ul style="list-style-type: none"> (2) Detex 10 Series device brushed stainless finish, for 36" door, pushpad activates signal switch - surface strike (#99), includes endcap with flexible conduit loop & fittings (1) Controller / Power Supply with wiring diagram (1) HR2 - Horn with adjustable tone settings (1) Keyswitch with momentary switching (Mortise cylinder included) (2) ECL-395 Delayed Egress, Code Compliant Peel & Stick Door Sign  <p>Note: Flex Conduit included (not shown)</p>	\$5,773.00

Contact factory for custom design EasyKits
EasyKits subject to additional restocking fee

One Part Number = One Easy Solution
 Easy to Specify, Easy To Order, Easy to Price, Easy to Sell, Easy to Install
 Best-in-class products, kitted together for custom solutions to common applications.

Below are several pre-configured EasyKits, however, Detex can create a more custom EasyKit for a specific application. Just contact your local sales representative or email your request to marketing@detex.com. For more information, visit our website at www.detex.com and click on Integrated Door Security Systems.

MODEL NO.	DESCRIPTION	PRICE
WDEx10EEXx1S-4	<p>Advantex Weatherized Request to Exit Signal Rim Exit Device with Controller and components for Single Door</p> <p>Kit Includes:</p> <ul style="list-style-type: none"> (1) Detex 10 Series Weatherized device, brushed stainless finish, for 36" door, pushpad activates signal switch - surface strike (#99), includes endcap with flexible conduit loop & fittings (1) Controller / Power Supply with wiring diagram and NEMA 4X enclosure (Nema Enclosure included but not shown) (1) HR2 - Outdoor Horn with adjustable tone settings (1) Keyswitch with momentary switching (Mortise cylinder included) (1) Protective Clear Plastic Cover for Keyswitch (not shown) (1) Outdoor Delayed Egress, Code Compliant Door Sign (not shown) <hr/>  <p>Note: Flex Conduit included (not shown)</p>	\$5,913.00
WDEx10EEXx1P-4	<p>Advantex Weatherized Request to Exit Signal Rim Exit Device with Controller and components for a Pair of Doors</p> <p>Kit Includes:</p> <ul style="list-style-type: none"> (2) Detex 10 Series Weatherized device, brushed stainless finish, for 36" door, pushpad activates signal switch - surface strike (#99), includes endcap with flexible conduit loop & fittings (1) Controller / Power Supply with wiring diagram and NEMA 4X enclosure (Nema Enclosure included but not shown) (1) HR2 - Outdoor Horn with adjustable tone settings (1) Keyswitch with momentary switching (Mortise cylinder included) (1) Protective Clear Plastic Cover for Keyswitch (not shown) (2) Outdoor Delayed Egress, Code Compliant Door Sign (not shown) <hr/>  <p>Note: Flex Conduit included (not shown)</p>	\$7,970.00

Contact factory for custom design EasyKits
 EasyKits subject to additional restocking fee

One Part Number = One Easy Solution
 Easy to Specify, Easy To Order, Easy to Price, Easy to Sell, Easy to Install
 Best-in-class products, kitted together for custom solutions to common applications.

Below are several pre-configured EasyKits, however, Detex can create a more custom EasyKit for a specific application. Just contact your local sales representative or email your request to marketing@detex.com. For more information, visit our website at www.detex.com and click on Integrated Door Security Systems.

MODEL NO.	DESCRIPTION	PRICE
EDx10EDx1S-1	<p align="center">Advantex Electrified Dogging Device with Power Supply and components for a Single Door</p> <p>Kit Includes: (1) Detex 10 Series Rim Exit Device with Electrified Dogging, brushed stainless steel finish, flex conduit loop, endcap and fittings, night latch pull trim (cylinder included) for 36" door width (1) Power Supply</p> <hr/> <div style="display: flex; justify-content: space-around; align-items: center;"> <div style="text-align: center;">  <p>Power Supply</p> </div> <div style="text-align: center;">  <p>03C Pull Trim</p> </div> <div style="text-align: center;">  <p>99 Strike</p> </div> <div style="text-align: center;">  <p>Advantex 10 Series Rim Exit Device</p> </div> <div style="text-align: right;"> <p>Note: Flex Conduit included (not shown)</p> </div> </div>	\$2,603.00

Contact factory for custom design EasyKits
 EasyKits subject to additional restocking fee

ELECTRIFIED DOGGING DOOR KITS CONT'D ON PAGE 125

MODEL NO.	DESCRIPTION	PRICE
EDx10EDKx1S-1	<p align="center">Advantex Electrified Dogging Device with Key Control for Campus Lockdown</p> <p>Kit Includes: (1) Detex 10 Series Rim Exit Devices with Electrified Dogging, brushed stainless steel finish, flex conduit loop, endcap and fittings, night latch pull trim (cylinder included) for 36" door width (1) Power Supply (1) Detex PB-2048-3 Central Control Switch</p> <hr/> <div style="text-align: center;">  <p>Electric Dogging with Key Control Exit Device</p> <p>Central Control Switch Note: Flex Conduit included (not shown)</p> <p>03C Trim Power Supply</p> </div>	\$2,746.00

Contact factory for custom design EasyKits
 EasyKits subject to additional restocking fee



AUTOMATICALLY OPERATED DOORS - LOW ENERGY APPLICATIONS

One Part Number = One Easy Solution

Easy to Specify, Easy To Order, Easy to Price, Easy to Sell, Easy to Install
Best-in-class products, kitted together for custom solutions to common applications.

Below are several pre-configured EasyKits, however, Detex can create a more custom EasyKit for a specific application. Just contact your local sales representative or email your request to marketing@detex.com. For more information, visit our website at www.detex.com and click on Integrated Door Security Systems.

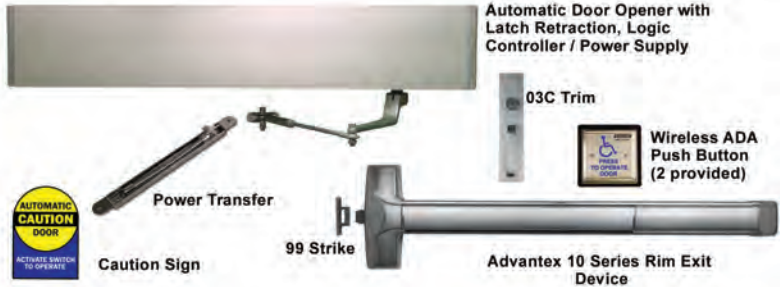
MODEL NO.	DESCRIPTION	PRICE
AODx10ERx1S-1	<p>Low Energy Automatic Door, Latch Retraction Exit Device with Power Supply for RHR/LH/AL Push, Single Door</p> <p>Kit Includes:</p> <ul style="list-style-type: none"> (1) AO19-1 Low Energy Automatic Door Operator, Controller / Power Supply (1) Detex 10 Series device with Electric Latch Retraction, brushed stainless finish, for 36" door, when energized both pushpad and latch is retracted, Surface strike (#99), 03C, night latch function pull trim with rim cylinder (1) Wiring diagram (1) Power Transfer - call ahead for template for door/frame prep (1) Wireless ADA, Knowing Act push buttons (kit includes 2 buttons) 	\$7,256.00
	 <p>Automatic Door Opener with Latch Retraction, Logic Controller / Power Supply</p> <p>03C Trim</p> <p>Wireless ADA Push Button (2 provided)</p> <p>Power Transfer</p> <p>Caution Sign</p> <p>99 Strike</p> <p>Advantex 10 Series Rim Exit Device</p>	

Contact factory for custom design EasyKits
EasyKits subject to additional restocking fee

AUTOMATICALLY OPERATED DOOR KITS - LOW ENERGY APPLICATION CONT'D ON PAGE 127

MODEL NO.	DESCRIPTION	PRICE
AODx21ERx1P-2	<p style="text-align: center;">Low Energy Automatic Door, Surface Vertical Rod Latch Retraction Exit Device with Power Supply for a pair of Push, AL Doors</p> <p>Kit Includes: (1) AO19-2 x CL x 75.5 Low Energy Automatic Door Operator. Controller / Power Supply (2) Detex 21 Series devices with Electric Latch Retraction, brushed stainless finish, for a pair of 36"x84" doors, when energized both pushpad and latch is retracted, Surface strike (#97), 03C, night latch function pull trim with rim cylinder (1) Wiring diagram (2) Power Transfer - call ahead for template for door/frame prep (1) Wireless ADA, Knowing Act push buttons (kit includes 2 buttons)</p> <hr/>  <p style="text-align: center;">Automatic Door Opener with Latch Retraction, Logic Controller / Power Supply</p> <p>Power Transfer</p> <p>Wireless ADA Push Button (2 provided)</p> <p>Advantex 21 Series Surface Vertical Top Rod Only Device (2 provided)</p> <p>CAUTION SIGN</p>	\$14,304.00

Contact factory for custom design EasyKits
 EasyKits subject to additional restocking fee

NOTES

*GUARD TOUR VERIFICATION,
SAFETY, SECURITY
AND RISK MANAGEMENT*



Order Conditions

Prices: Prices are subject to change without notice. **No prices are guaranteed;** all shipments will be made at prices prevailing at the time of receipt of order.

Terms: Net 45 days. Past due accounts may be subject to a shipping hold.

Acceptance: We reserve the right to decline an order, in whole or part, when the type or quantity of goods or the creditworthiness of the purchaser is not satisfactory.

Delivery: Most products can be shipped within 48 hours. All shipments are F.O.B. New Braunfels, Texas.

Returned Goods: Materials may be returned for credit within six (6) months of purchase. No goods will be accepted for return unless a **Return Materials Authorization** has been issued. Contact your area Sales Administrator with requests. **Returns must be unused and in original packaging.** Credit will be issued at price paid or current price, whichever is lower, less a 25 percent restocking charge. Obsolete, discontinued or special products are not returnable.

Special Order Items: Special order items for a specific customer requirement and specialized one-of-a-kind products are non-returnable and non-cancellable, and may require a prepayment of 50 percent.

Cancellation and Changes: A cancellation or change order charge will apply if any costs for material or labor have been incurred by us prior to notification from the customer.

Corrections: We expressly reserve the right to correct clerical, stenographic and other obvious errors at any time.

Limited Warranty: All Detex guard tour products are warranted to be free of defects in material and workmanship when properly installed, used and maintained according to instructions. We will, for a period of **one year*** from the date of purchase, repair or replace any part which, upon our examination, proves to be defective under normal use. (This does not apply to batteries or to damage from battery leakage.) This warranty will be honored only upon presentation of proof that the product covered thereby was purchased directly from an authorized Detex distributor. **WE SHALL NOT BE LIABLE FOR ANY DIRECT, INCIDENTAL OR CONSEQUENTIAL LOSS OR DAMAGE ARISING OUT OF THE FAILURE OF THE PRODUCT OR DEVICE.**

***Exceptions:** GCS ProxiPen, 3 years; Reliant DAU, 2 years



ProxiPen

TopGuard Patrol

	PART NUMBER	DESCRIPTION	PRICE
	GCS-PP-KIT	ProxiPen Kit 120 - Basic ProxiPen System: Includes ProxiPen-2, Data Transfer Unit (w/USB Cable), TopGuard Patrol Software, (20) 30mm RFID Tags	\$1,310.00
	PROXIPEN-2	ProxiPen-2 RFID Tag Reader	\$750.00
	GCS-PP-INCBK	ProxiPen Incident Book (with 20 RFID Tags)	\$105.00



ACCESSORIES

PART NUMBER	DESCRIPTION	LIST
PP-2-BAT-CAP	Battery Cap for ProxiPen-2	\$38.00
GCS-PP-DTU	Data Transfer Unit (DTU) for ProxiPen (Serial & USB)	\$420.00
GCS-PP-DTU-CAB	Serial Data Cable for ProxiPen DTU	\$24.00
GCS-PP-DTU-USB	USB Cable for ProxiPen DTU	\$24.00
GCS-PP-DTU-PS	Power Supply for ProxiPen DTU, 120/240 VAC, USA/UK/EUR adapters	\$39.50
GCS-PP-TAG20-U	RFID Tag, 20mm diameter (Unique - Random Hex Number)	\$6.00
GCS-PP-TAG30-U	RFID Tag, 30mm diameter (Unique - Random Hex Number)	\$3.90
GCS-PP-TAG20-N	RFID Tag, 20mm diameter (Nova - GCS 8-Digit Number)	\$8.50
GCS-PP-TAG30-N	RFID Tag, 30mm diameter (Nova - GCS 8-Digit Number)	\$8.00
GCS-PP-TAG50-N	RFID Tag, 50mm diameter (Nova - GCS 8-Digit Number)	\$9.00
GCS-PP-WB-U	Wristband RFID Tag (Unique - Random Hex Number)	\$12.75
GCS-PP-CRD-U	Proximity RFID Card with Magstripe (Unique - Random Hex Number)	\$6.20
GCS-PP-KF-U	Keyfob RFID Tag (Unique - Random Hex Number)	\$10.50
GCS-PP-HOL	ProxiPen Holster	\$60.00
HOLST-PP-CLIP	Belt Clip for ProxiPen Holster	\$11.50
GCS-TGP	TopGuard Patrol Software	\$395.00
GCS-TGPLUS	TopGuard Patrol PLUS Software	\$999.00
GCS-TGP-ESC-USB	Belkin F5U103 Serial-to-USB Adapter	\$192.00
GCS-6066	Safety Chain	\$12.00

NOTES:

1. Part no. GCS-PP-NT-110 (Power Supply for ProxiPen DTU, 110/120 VAC) has been replaced by part no. GCS-PP-DTU-PS
2. Part no. GCS-WINDAU-E (WinDAU Software - Enterprise Version) has been replaced by part no. GCS-TGPLUS

DETEX[®] RELIANT[™] PLUS

	PART NUMBER	DESCRIPTION	PRICE
	REL-PLUS-KIT-8	Reliant PLUS System Kit - Includes REL-DAU-8 Reliant Data Acquisition Unit; Nylon Holster; REL-DTU-8 Data Transfer Unit (USB); Reliant PLUS Software CD, includes User Manual (PDF); (2) iButton [®] ID Keys; (10) Checkpoints (including iButtons); (1) Incident Book & Keypad; Casing Security Key	\$715.00
	REL-DAU-8	M8000 Reliant Data Acquisition Unit (DAU)	\$395.00
	REL-INCBK	Reliant Incident Book & Keypad	\$106.00

ACCESSORIES - RELIANT PLUS

PART NUMBER	DESCRIPTION	LIST
REL-HOL	Nylon Holster for Reliant DAU	\$13.00
REL-CKP	Checkpoint (complete with iButton)	\$10.50
REL-CKP-MNT	Checkpoint Mount (clamshell, w/o iButton)	\$2.75
REL-CKP-MNT2	Checkpoint Mount (one-piece ABS, w/screws, w/o iButton)	\$2.75
REL-CKP-MNT3	Checkpoint Mount (one-piece aluminum, w/screws, w/o iButton)	\$4.50
REL-IB	iButton only	\$4.75
REL-BDG	iButton Badge (complete)	\$14.00
REL-BDG-MNT	iButton Badge Mount	\$4.25
REL-KF	iButton ID Key (colored keyfob)	\$8.75
REL-PLUS-2	Reliant PLUS II Software (CD), includes User Manual (PDF)	\$99.00
REL-DTU-8	P8000 Reliant Data Transfer Unit (USB)	\$130.00
REL-CSKEY	Casing Security Key for Reliant DAU	\$15.00
REL-MDTU-8	T8000 Mobile Data Transfer Unit	\$429.00



The Escorte product line has been obsoleted by GCS, effective at the end of 2009. The WinArgus software is effectively obsolete as well, since it works only with Escorte.

We have a limited supply of Escorte products on hand, which will be available until the supply is exhausted. Contact us for availability and pricing.

Repairs on Escorte hardware will be available until our supply of repair parts is exhausted. The Escorte power pack will be manufactured and available until there is no longer a demand for it.

Where Trust is Built™





Detex Corporation discontinued the production and sale of the Newman, Guardsman, Safe-T-Chek and Newman Quartz watchlocks effective **December 31, 2011**.

Current inventories of watchlock accessories will be available until depleted.

Support for current watchlock users is planned to be available through **December 31, 2016**, to include repair parts, service and consumables (tapes and dials).

GUARDSMAN		
PART NO.	DESCRIPTION	LIST
TP-5	Leather pouch and carrying strap for Guardsman Watchclock	\$66.15
BX-TAPE	Paper Tapes (Box of 24 Rolls) - Up to 66 Boxes	\$27.46
	Paper Tapes (Box of 24 Rolls) - 66 Boxes or more	\$26.09
TF-8	Guardsman Watchclock Tape File	\$30.45
TCMK-3MT	Lock Key, Master	\$11.25
TCMK-3T-[X]	Lock Key, Spare; [X] = 0 - 9	\$3.89

NEWMAN & NEWMAN QUARTZ		
PART NO.	DESCRIPTION	LIST
P2K-16A	Leather pouch and carrying strap for Newman Watchclock	\$55.13
101967	Nylon pouch and carrying strap for Newman Quartz Watchclock	\$37.50
BX-3924	Paper Dials (Box of 320) - Up to 96 Boxes	\$21.63
	Paper Dials (Box of 320) - 96 Boxes or more	\$20.53
CK-33	Lock Key	\$3.31
MM-103	Dial Nut	\$14.70
101958	"AA" Battery (Newman Quartz ONLY)	\$3.41
101957	Battery Clip (Newman Quartz ONLY)	\$5.25

For GUARDSMAN, NEWMAN or NEWMAN QUARTZ		
PART NO.	DESCRIPTION	LIST
K2K-22	Recording Key & Chain Only (specify station number 1 thru 40)	\$13.23
MM-92	Winding Key	\$1.68



STATIONS		
PART NO.	DESCRIPTION	LIST
SDA-90	Complete Station (Box & Recording Key) - Aluminum, surface-type, without lock	\$22.05
SDC-90	Complete Station (Box & Recording Key) - Cycolac ABS thermoplastic, surface-type, without lock	\$16.54
SSK-90	Complete Station (Box & Recording Key) - Drawn Steel, surface-type, without lock	\$40.95
SSKL-90	Complete Station (Box & Recording Key) - Drawn Steel, surface-type, with lock	\$68.25
SDA-75	Station Box only - Aluminum, surface-type, without lock	\$8.82
SDC-75	Station Box only - Cycolac ABS thermoplastic, surface-type, without lock	\$3.31
SSK-75	Station Box only - Drawn Steel, surface-type, without lock	\$27.56
SSKL-75	Station Box only - Drawn Steel, surface-type, with lock	\$55.13
KK-1	Attaching Anchor Chain	\$0.16
KK-11B	Seal Holder	\$0.21
SH-39	Station Box Mounting Screw	\$0.11
KK-31	Seal	\$0.11
SDC-57	Washer	\$0.16
SD-18P-[X]	Station I.D. Numerals; [X] = 0 thru 9	\$0.11
SH-17	Key Lock, complete	\$7.35

SAFE-T-CHEK		
PART NO.	DESCRIPTION	LIST
BX-STC-75	Paper Dials (Box of 52)	\$35.28
STC-7011	Record Cylinder	\$9.98
STC-7011-[XX]A	Record Key; [XX] = 1 thru 30	\$1.30
STC-7012	Access Cylinder	\$10.13
STC-7012-[XX]A	Access Key; [XX] = 31 thru 40	\$1.10
STC-7069	Battery Date Label	\$0.63
MM-103	Dial Nut	\$14.70

NOTES

For most up to date price
list, please scan code:



Where Trust is Built™
DETEX®
Life Safety, Security and Security Assurance

Detex Corporation
302 Detex Drive
New Braunfels, Texas 78130-3045 USA
PH: (830) 629-2900
(800) 729-3839
FAX: (830) 620-6711
(800) 653-3839
<http://www.detex.com>
USA Sales:
marketing@detex.com
International Sales:
export@detex.com