



BEYOND SECURITY

KABA[®]

E-PLEX[®]

1" MORTISE INSTALLATION INSTRUCTIONS

TABLE OF CONTENTS

Tools Required	3
Exploded Install Parts	4
Handing Diagram	5
A. Mortise Handing	5
B. Door Preparation	6
C. Installing the Strike	7
D. Installing Outside Unit Assembly	8
E. Installing Inside Unit Assembly	9
F. Installing the Inside Lever	9
G. Changing Key-In-Lever Cylinder	10
H. Installing / Removing Outside Lever (Key-In-Lever) KIL	11
I. Installing / Removing Outside Lever (Interchangeable/ removable core models)	11
J. Installing the Battery Pack and Cover	13
K. Testing the Operation of the Lock	14
L. Programming and Software Settings	14
M. Installing Rubber Bumpers	15

Warning

The Master Code of this lock has been factory preset: 1,2,3,4,5,6,7,8. To activate lock functions, the master combination must be changed at time of installation.

Warnings and Cautions

Important: Carefully inspect windows, door frame, door, lights, etc. to ensure that the recommended procedures will not cause damage. Kaba Access Control's warranty does not cover damages caused by installation.

Caution: Wear safety glasses when preparing door.

Introduction

The purpose of this manual is to instruct the installer on the proper installation procedure for the E-Plex 5x63, 5x64, 5x68 and 5x69 1" American Steel Mortise (ASM) Mortise locks. These instructions pertain to models with and without deadbolts. For models without deadbolts, please disregard any references to a thumbturn in the instructions.

OPERATIONAL NOTE:

The E-Plex Mortise lock is almost identical to the E-Plex 5000 Cylindrical lock with the following exceptions:

- 1. Operation of the Lever** When the lock's handing is properly set, only a downward rotation of lever will actuate latch.
- 2. Key Override Use** The key override differs in that rotating the key does not actuate the latch. To use the key override the key must be inserted into the cylinder and rotated counter clockwise until it stops (approximately 90 degrees) then while holding the key in this position with one hand use the other hand to rotate the lever downward to retract the latch. Once the lever has rotated a few degrees the key may be released.

TOOLS REQUIRED

- Safety glasses
- ½" (13 mm) chisel
- ⅛" (3 mm) drill bit
- ¼" (7 mm) drill bit
- ½" (13 mm) drill bit
- 2⅛" (54 mm) hole saw
- Drill
- Awl or center punch
- Hammer
- Small flat screwdriver
- Philllips screwdriver (#2)
- Fine steel file
- Mortising machine
- Router
- Mortise faceplate router template
- Adjustable square
- Tape measure
- Pencil
- Tape
- Cleaning supplies (drop cloth, vacuum)

E-PLEX 1" Mortise Lock 5x63, 5x64, 5x68 and 5x69

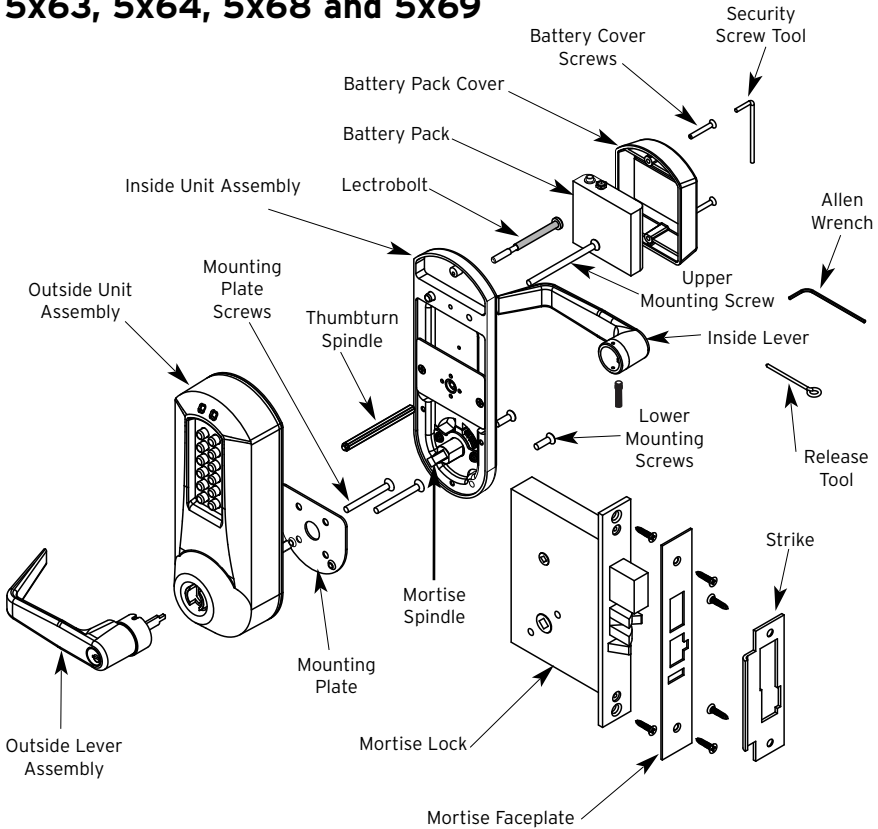

INSTALLATION QUALIFICATIONS

These instructions are designed for use by maintenance professionals or lock installers who are familiar with common safety practices and competent to perform the steps described. Kaba Access Control is not responsible for damage, injury or malfunction due to incorrect installation.



For technical assistance please call
1-800-849-TECH (8324) or 336-725-1331

Handing Diagram

To determine handing, face the door from the exterior (access) side and select the corresponding diagram below.

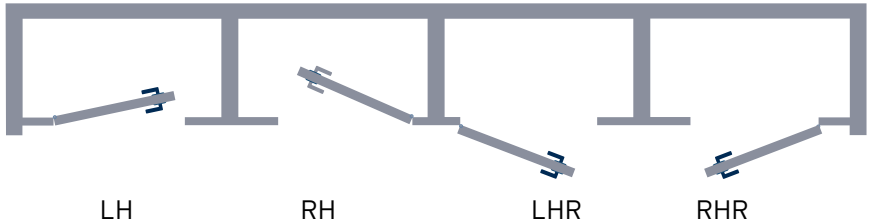

Chart

Model Number	Handing	Deadbolt
E5x63	LH/RHR	No
E5x64	RH/LHR	
E5x68	LH/RHR	Yes
E5x69	RH/LHR	

A. MORTISE HANDING

The 1" Mortise is not field reversible. You must have the appropriate model for the door handing of the installation.

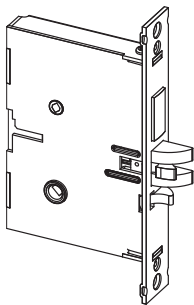

For LH (left hand) and
RHR (right hand reverse)

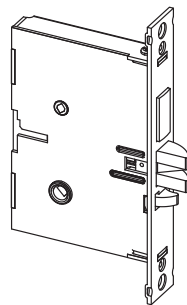

For RH (right hand) and
LHR (left hand reverse)

B. DOOR PREPARATION

If using the installation jig to prepare the door, refer to the instructions provided with the jig, then proceed with step 7.

- B-1** Mark the handle height on the edge of the door, as determined directly from the strike.

**Lever Centerline =
Bottom Edge of Strike lip**

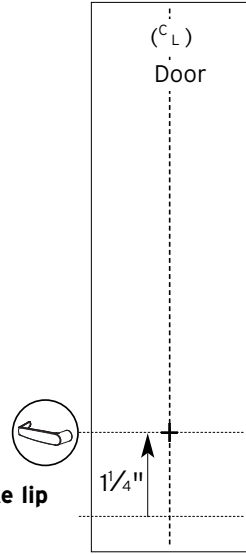

The axis of rotation of the handle is level with the bottom lip of the strike.

- B-2** Align the template along the vertical center line of the mortise (CL) at the desired handle height, and tape it to the door.

- B-3** Mark all holes and cutouts for the mortise in the edge of the door and remove the template.

- B-4** Locate the two sets of vertical fold lines on the template allowing you to adjust the positioning of the template depending on the bevel of the door.

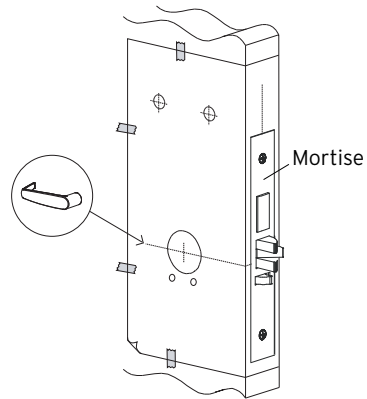

Note: Fold lines on template are for 1 3/8" door. Some thickness and bevel conditions may make it necessary to re-position the template for marking each side of the door.

- B-5** If the door has no bevel, fold the template along the solid lines. Align the fold with the edge of the door and mark the holes for the lock.

Repeat on the other side of the door. If the door has a 3° bevel, fold and align the dashed line marked "H" on the template with the higher-beveled edge of the door and mark the lock holes on that side of the door. Repeat on the side with the lower-beveled edge using the dashed line marked "L."

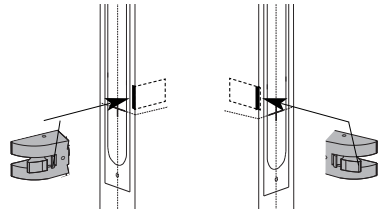

RH/LHR (ASM shown) LH/RHR

- B-6** Prepare the cutout for the mortise in the edge of the door using a mortising machine, router and chisel (for dimensions, refer to template). Ensure clearance is provided for moving latch parts as indicated on the template.
- B-7** When making holes, drill from both sides of the door to prevent unsightly damage (for dimensions, refer to template). Drill the small holes before the large holes. This will keep small holes on location before the 2 1/8" holes are made tangent with them.
- B-8** Check the bevel of the mortise faceplate. If adjustment is required, loosen the two bevel screws (R) and adjust mortise front plate angle to match the bevel of the door.
- B-9** Re-tighten screws.
- B-10** Install the mortise with two 1" Phillips screws (Q) provided.
- B-11** Install mortise faceplate (P) with the two 8-32 x 1/4" screws provided.

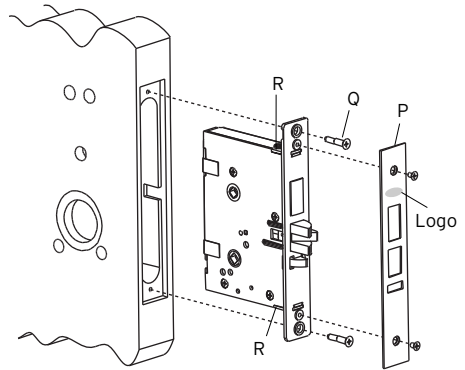

C. INSTALLING THE STRIKE

- C-1** Align the paper template on the door frame to match with the desired handle height, and along the vertical center line of the mortise (CL), which is also the center line of the door, allowing for any bumpers on the door frame.

Respect applicable building codes regarding handle height.

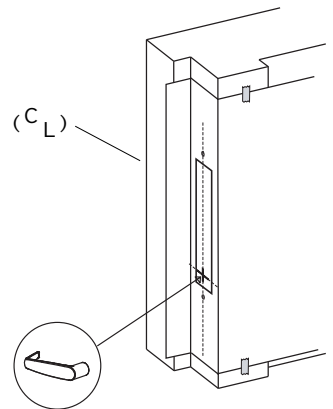

- C-2** Select the strike for the desired handing, according to the depiction on the template. Mark the location of the strike cutout and mounting screws.

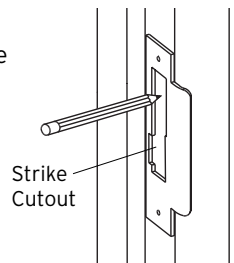

- C-3** Drill pilot holes for the strike mounting screws.
Mortise the door frame for the strike dimensions shown. 3 3/8" (L) X 1" (D) X 1" (W)

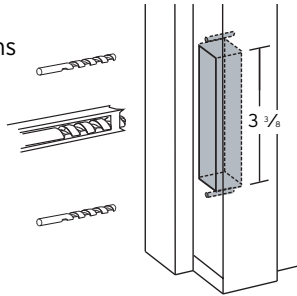

Note: Make certain not to mortise over screw holes drilled earlier.

- C-4** Position the strike against the door frame and align it with the mounting screw holes. Then mark the outline of the strike.

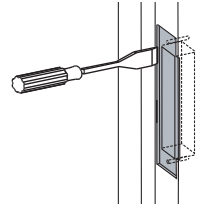

- C-5** Remove any material from within the strike outline (a) so that the strike will be flush with the door frame.

- C-6** Install the strike using the screws provided.

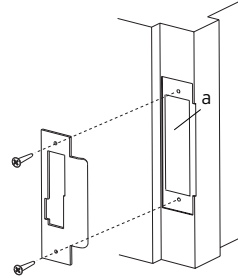

D. INSTALLING OUTSIDE UNIT ASSEMBLY

Note: Ensure that the mounting hole for the red collars is cleaned out so that the collars are not crushed upon installation. If necessary, the hole can be opened up to 5/16".

- D-1** For door thickness of 1 3/8", insert the square spindle (G) into the outside housing hub.
- D-2** If your lock comes with a thumbturn, insert the end (with the ring groove) of the thumbturn spindle (F) into the small spindle hole in the outside housing.

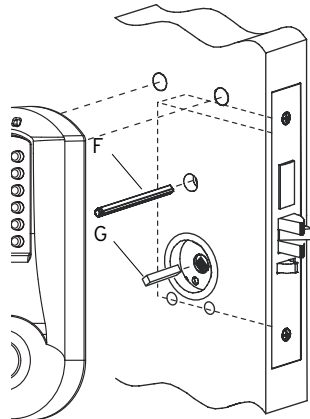

- D-3** Place the outside housing on the door so that the bottom spindle engages the hub on the mortise, and the top thumbturn spindle passes through the mortise top hub. The outside unit assembly (c) will rest flush against the door. Ensure the red collar is seated into the top left mounting hole.

E. INSTALLING INSIDE UNIT ASSEMBLY

E-1 Place inside mounting plate flush against the door as shown. For a door thicknesses of 1 3/8" insert diagonally (as shown) two 1 1/2" Phillips flat head screws (supplied in parts door kit).

Note: The screws must correspond to the two through holes in the mortise.

E-2 Insert the square spindle (G) into the inside housing hub.

E-3 Put the thumbturn (T), if applicable in a vertical position and place the inside trim assembly on the door so that the upper spindle (F) engages the thumbturn and mortise hubs, respectively. Ensure the red collar is seated into its mounting hole. Carefully push the inside housing flush against the door.

E-4 Supplied hardware should correspond to the chart below:

Door Thickness	LectroBolt Size	Top Mounting Screw Size	Lower Mounting Screws
1 3/8" (35 mm)	2 3/8" (60 mm)	2 1/2" (64 mm)	5/8" (16 mm)

E-5 Insert the LectroBolt™ through the red inside housing hole marked with the lightning bolt symbol. For now, only partially tighten the LectroBolt™ to keep the red collars in position.

E-6 Then, insert and tighten the other three mounting screws. (Refer to the chart for correct screw lengths.)

E-7 Finish tightening the LectroBolt™ to secure the lock on the door.

Warning: If using a power drill, please be careful not to over-tighten as this could cause damage to the mounting screws and threads.

F. INSTALLING THE INSIDE LEVER

Insert the inside lever (A) onto the inside unit assembly. Secure the inside lever with the hex screw (B) (supplied) using the allen wrench (C) (supplied).

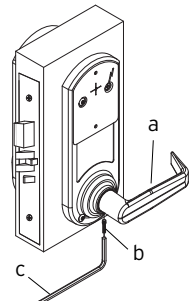
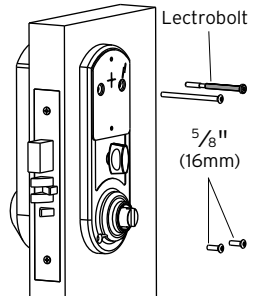
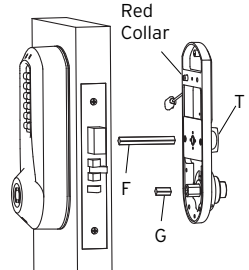
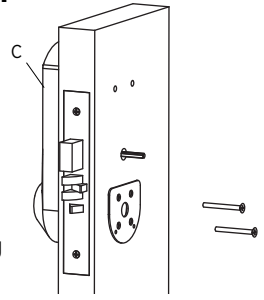

KABA E-PLEX® 5x00 SERIES LIMITED WARRANTY

Kaba Access Control warrants this product to be free from defects in material and workmanship under normal use and service for a period of three (3) years. Kaba Access Control will repair or replace, at our discretion, 5000 Series Locks found by Kaba Access Control analysis to be defective during this period. Our only liability, whether in tort or in contract, under this warranty is to repair or replace products that are returned to Kaba Access Control within the three (3) year warranty period.

This warranty is in lieu of and not in addition to any other warranty or condition, express or implied, including without limitation merchantability, fitness for purpose or absence of latent defects.

ATTENTION: This warranty does not cover problems arising out of improper installation, neglect or misuse. All warranties implied or written will be null and void if the lock is not installed properly and /or if any supplied component part is substituted with a foreign part. If the lock is used with a wall bumper, the warranty is null and void. If a doorstop is required, we recommend the use of a floor secured stop.

The environment and conditions of use determine the life of finishes on Kaba Access Control products. Finishes on Kaba Access Control products are subject to change due to wear and environmental corrosion. Kaba Access Control cannot be held responsible for the deterioration of finishes.

Authorization to Return Goods

Returned merchandise will not be accepted without prior approval. Approvals and Returned Goods Authorization Numbers (RGA Numbers) for the 5000 Series are available through our Customer Service department in Winston-Salem, NC (800) 849-8324. **The serial number of a lock is required to obtain this RGA Number.** The issuance of an RGA does not imply that a credit or replacement will be issued.

The RGA number must be included on the address label when material is returned to the factory. All component parts including latches and strikes (even if not inoperative) must be included in the package with return. All merchandise must be returned prepaid and properly packaged to the address indicated.

* Simplex 5000 locks are warranted three (3) years from date of purchase. E-Plex 5x00 locks are warranted three (3) years from date of activation.

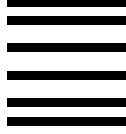

NO POSTAGE
NECESSARY
IF MAILED
IN THE
UNITED STATES

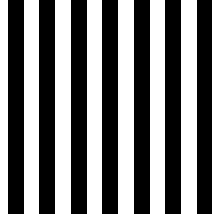

BUSINESS REPLY MAIL

FIRST-CLASS MAIL

PERMIT NO. 1563

WINSTON-SALEM, NC

POSTAGE WILL BE PAID BY ADDRESSEE

KABA ACCESS CONTROL
2941 INDIANA AVENUE
WINSTON-SALEM, NC 27199-3770

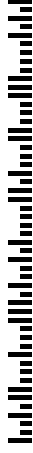

REGISTRATION CARD

Thank you for purchasing our product. In order to protect your investment and to enable us to better serve you in the future, please fill out this registration card and return it to Kaba Access Control, or register online at www.kabaaccess.com.

Name _____

Position _____

Company _____

Address _____

City _____

State _____ ZIP (Postal Code) _____ Country _____

Phone _____

Email _____

Name of Dealer Purchased From _____

Date of Purchase _____

Lock Model Number _____

This lock will be used in what type of facility?

- | | | |
|----------------------------------------------|-------------------------------------------------------|---------------------------------------------|
| <input type="checkbox"/> Commercial Building | <input type="checkbox"/> Industrial / Manufacturing | <input type="checkbox"/> Airport |
| <input type="checkbox"/> College/University | <input type="checkbox"/> Government/Military | <input type="checkbox"/> School/Educational |
| <input type="checkbox"/> Hospital/Healthcare | <input type="checkbox"/> Other (please specify) _____ | |

What area is being secured with this lock? (e.g. Front Door, Common Door, Exercise Room)

This lock is:

- New Installation
- Replacing a conventional keyed lock
- Replacing a Kaba Mechanical Pushbutton Lock
- Replacing a Kaba Electronic Access Control
- Replacing a Keyless Lock other than Kaba

How did you learn about Kaba Access Control Pushbutton Locks?

- | | | | |
|----------------------------------------|---------------------------------------|-----------------------------------------|-------------------------------------------------|
| <input type="checkbox"/> Advertisement | <input type="checkbox"/> Previous Use | <input type="checkbox"/> Internet / Web | <input type="checkbox"/> Another Use |
| <input type="checkbox"/> Locksmith | <input type="checkbox"/> Maintenance | <input type="checkbox"/> Training Class | <input type="checkbox"/> Other (please specify) |

What was your reason for buying this lock? _____

Who installed your lock?

- | | | |
|------------------------------------|--------------------------------------|--------------------------------------|
| <input type="checkbox"/> Locksmith | <input type="checkbox"/> Maintenance | <input type="checkbox"/> Other _____ |
|------------------------------------|--------------------------------------|--------------------------------------|

Check here if you would like more information on Kaba Access Control locks.

G. CHANGING KEY-IN-LEVER CYLINDER



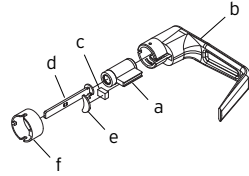

On key-in-lever models of the E-Plex 5000 series, the outside lever comes preassembled with Kaba's key-in-lever cylinder (Kaba 1599). To use a different key-in-lever cylinder follow remaining steps in this section.

G-1 To remove KIL (key-in-lever) cylinder (a) from the outside lever (b). Remove the cylinder insert (e) and the cylinder retainer (c) using a small flat bladed screwdriver or small needle nose pliers.

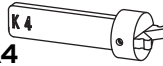

G-2 Determine the proper tailpiece (d) from the chart below for your KIL cylinder.

You must use a Kaba tailpiece. The K 2 tailpiece is preassembled with the Kaba 1599.

TAILPIECE	KIL CYLINDER
 K1	Abloy 5277, Abloy 5477, Assa 65691, Kaba 1539, Kaba Gemini 4730
 K2	Assa 65611, Australian: Kaba expert 107K5 & Boyd KC286, Corbin-Russwin 2000-03, Kaba 1599, Schlage 23-001, Schlage Primus 20-760, Kaba Peaks 1099
 K3	Medeco 20W200H1
 K4	Arrow C100, Sargent 10 LINE
 K5	Marks

G-3 Assemble the required tailpiece (d) (from above) with your KIL cylinder. All tailpieces must be installed vertically (with key removed from cylinder) for proper installation.

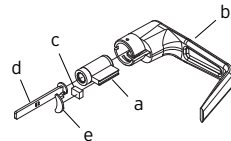

G-4 Insert the KIL cylinder (a) into the outside lever and secure it with the cylinder retainer (c) and the cylinder insert (e) until the KIL cylinder is snug and unable to move freely.

H. INSTALLING / REMOVING OUTSIDE LEVER

(Key-In-Lever models only)

- H-1** Make certain the lever catch is up as shown (c). To successfully install the outside lever, the lever sleeve (f) tab must be positioned correctly with the respective notch on the lever. The lock comes shipped with the lever sleeve already installed in the lock housing. When installing lever, ensure it is oriented to engage the lever sleeve to accommodate desired lock handing as shown.

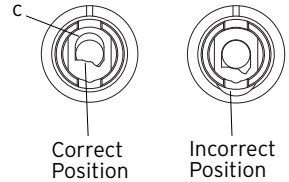

- H-2** Insert one of the supplied keys (a) into the outside lever (b) and rotate key counterclockwise 45 degrees.

- H-3** Insert the outside lever (b) until it is flush to the outside unit assembly (g). Secure the outside lever by rotating the key (a) clockwise 45 degrees to horizontal position. Remove key.

Note: To remove the outside lever from the outside unit assembly, follow the step below.

- H-4** Insert one of the supplied keys (a) into the outside lever and rotate it counterclockwise 45 degrees. Insert release tool (d) into the small hole (e) under lever as shown. Gently push lever catch up until it clicks. Remove tool, then remove outside lever (b).

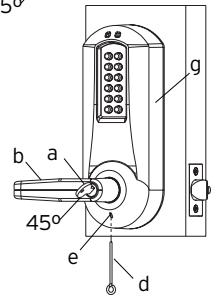
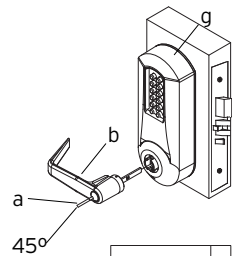
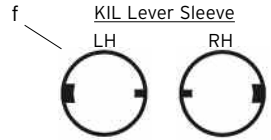

I. INSTALLING / REMOVING OUTSIDE LEVER

(Interchangeable / Removable Core Models)

- I-1** Make certain the lever catch is up as shown (c). To successfully install the outside lever, the lever sleeve (f) tab must be positioned correctly with the respective notch on the lever. The lock comes shipped with the lever sleeve already installed in the lock housing. When installing lever, ensure it is oriented to engage the lever sleeve to accommodate desired lock handing as shown.

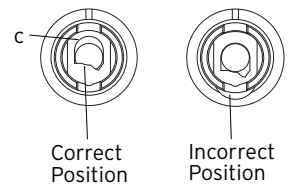

Note: For all interchangeable/removable cylinders except ASSA/Medeco/Yale, proceed to section I-2. For ASSA/Medeco/Yale cylinders, skip to section I-5.

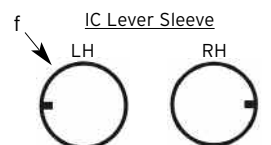

I-2 Insert the outside lever (a) until it is flush to the outside unit assembly (b). To secure the outside lever, insert the release tool (d) (or screwdriver) into the outside lever as shown, and slide the lever catch down until it clicks. Make certain lever is attached before installing the core.

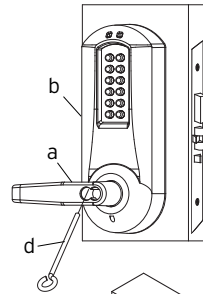

I-3 Insert the supplied tailpiece (e) vertically into the outside lever as shown. Make certain that you rotate the tailpiece so that it will align with the interchangeable core. For screw cap type cylinders (Schlage) (g), the tailpiece must be assembled to the cylinder first as shown (vertical position). Insert the interchangeable core into the outside lever.

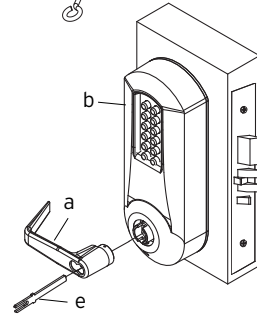

Note: To remove the outside lever from the outside unit assembly, follow steps below.

I-4 Remove the interchangeable core (g). Then remove the tailpiece (e).

I-5 For ASSA/Medeco/Yale interchangeable/removable cylinders, the tailpiece must be prepped for the desired length before installation.

When using a Yale cylinder on a cylindrical latch application, measure the door thickness of the intended application.

I-6 Notice the score marks on the flat portion of the ASSA/Medeco/Yale tailpiece. Using the diagram to the right, locate the score mark on your tailpiece that matches your cylinder prep for the intended application, and break the tailpiece off accordingly.

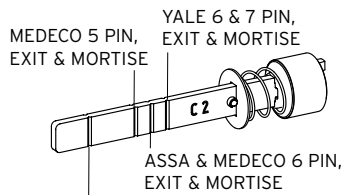

I-7 Using 2 pairs of pliers, break the tailpiece to the desired length of the intended application by holding 1 pair of pliers on the good side of the score mark and one pair on the other side of the score mark. Slowly move the 2nd pair of pliers up and down until the unneeded portion of the tailpiece breaks free.

YALE 6 & 7 PIN,
CYLINDRICAL - THIN DOOR
(1 3/8" (35 mm) to 1 1/2" (38 mm))
(DO NOT SHORTEN TAILPIECE -
For 1 5/8" (41 mm) to 2 1/4" (57 mm))

I-8 Insert the Medeco tailpiece (e) vertically into the outside lever as shown. Make certain that you rotate the tailpiece slightly so that it will align with the interchangeable/removable cylinder. Insert the interchangeable/removable cylinder into the outside lever.

ASSA/MEDECO 5, 6 & 7 PIN,
CYLINDRICAL - DO NOT SHORTEN TAILPIECE

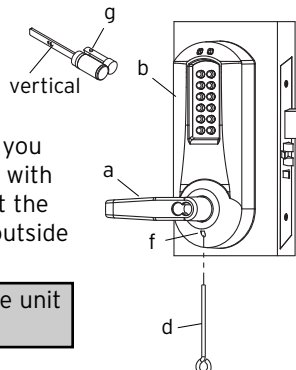

Note: To remove the outside lever from the outside unit assembly, follow steps below.

I-9 Remove the interchangeable/removable cylinder. Then remove the tail-piece (e).

Note: You may want to use needle nose pliers for some tailpieces.

I-10 Insert the lever release tool (d) into the small hole (f) under lever as shown. Gently push lever catch up until it clicks. Remove tool, then remove outside lever (a).

Note: You may want to use needle nose pliers for some tailpieces.

Insert the release tool (d) into the small hole (f) under the lever as shown. Gently push lever catch up until it clicks. Remove tool, then remove the outside lever (a).

Note: Do not shut door until installing batteries and testing operation as outlined in the following two sections.

J. INSTALLING THE BATTERY PACK AND COVER/CHANGING BATTERIES

J-1 To install the battery pack (f) and cover (g), snap the cable connector onto the top of the loaded battery pack. Then place the battery pack into the cover, terminals at the top. Put the two security screws (h) into the cover and fasten the cover to the inside housing with the security screw tool (i).

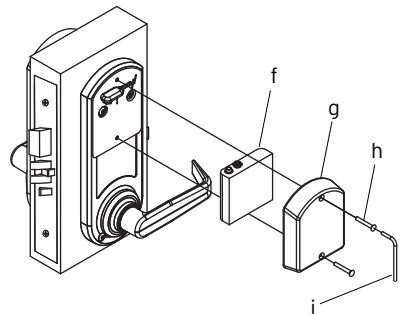

Caution: Over-tightening these screws could strip the threads in the housing or crack the cover.

Warning: If the lock goes without power for more than two minutes, you will lose the lock's current date and time only. If this happens, program the lock with the correct date and time. Refer to Operations Manual.

J-2 Remove the two screws (h) securing the battery cover to the housing, using the security screw tool (i) provided with your lock.

J-3 Remove the four depleted batteries and install four new Alkaline **only** AA batteries. Ensure that each battery is installed in the proper direction as shown at each battery location in the battery holder (f).

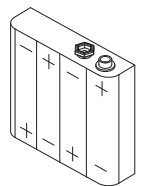

Warning: Do not install a 9V battery. Your lock operates on 4 alkaline **only** AA batteries (6V). A 9V will ruin the electronics in the lock, and void your warranty!

- J-4** Reconnect the battery cable. Place the battery holder into the cover. Screw the back cover onto the inside housing, ensuring that the cable is not trapped under the edge of the cover.

Caution: Over-tightening these screws could strip the threads in the housing or crack the cover.

K. TESTING THE OPERATION OF THE LOCK

- K-1** Rotate inside lever and hold. Ensure that the mortise latch is fully retracted and flush with the mortise faceplate. Release the inside lever; the latch should be fully extended.
- K-2** Enter the factory-set combination: 1,2,3,4,5,6,7,8. You should see a green light and hear a high-pitched tone as you push each button. When the lock opens you will briefly hear the sound of an electric motor. If 1,2,3,4,5,6,7,8 does not seem to work, please follow the steps to perform a hard reset by following the procedure in section L.
- K-3** Rotate outside lever and hold. Ensure that the latch is fully retracted and flush with the latch faceplate. Release the outside lever; the latch should be fully extended. When the lock re-locks, you will again hear the motor.
- K-4** Insert key into the outside lever. Rotate key counterclockwise to stop position and hold. Ensure that the latch is fully retracted and flush with the latch faceplate. Rotate the key clockwise to the horizontal position and remove the key. The latch should be fully extended.
- K-5** To test the deadbolt function (where applicable), turn the thumbturn knob to extend the deadbolt. A red light should flash once. Then, turn the thumbturn again and verify that the deadbolt is retracted and there is a flash of the green light.

Note: Refer to the Operating Manual to set up lock operation.

L. PROGRAMMING AND SOFTWARE SETTINGS:

- L-1** You must change the master Code from the factory default to another code to program the lock. For further information on how to manually program the E-Plex 3x00/5x00 Series Models, refer to the companion "E-Plex 3x00/5x00 Operation Manual." Software is required to program the E3200/E5200 Series Locks.
- L-2** When configuring the E3000/E5000 Series Locks using the optional Standard Software, choose the box that contains "Entry Lock with Passage (Cylindrical or Mortise without Deadbolt)" during lock setup.
- L-3** When configuring the E3200/3700 and E5200/E5700 Series Locks using the Enterprise Software, select the appropriate lock type during lock setup. .

M. INSTALLING RUBBER BUMPERS

M-1 Close the door and apply pressure making sure the deadlatch (a) rests on the strike plate (b) as shown. Standing on the frame (door step) side of the door, check for gaps between the door and the frame on the three sides of the frame (left, right and top).

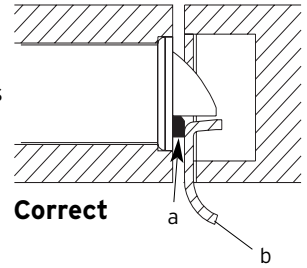

M-2 Mark locations where the gaps are approximately $\frac{3}{16}$ " (5 mm). Make sure these locations are free from grease and dust. Peel the bumpers (c) (supplied) from their protective backing without touching the adhesive surface and stick them on the marked locations.

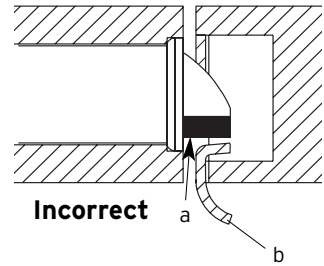

Note: Allow 24 hours for bumper adhesive to set before testing. The door may be operated manually during this time.

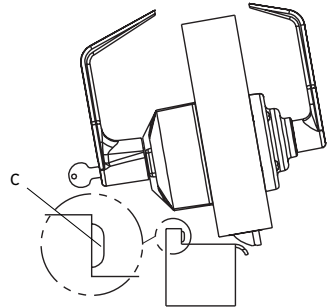

KABA®

BEYOND SECURITY

Kaba Access Control
2941 Indiana Avenue
Winston-Salem, NC 27105 USA
Tel: (800) 849-8324 (336) 725-1331
Fax: (800) 346-9640 (336) 725-3269

www.kabaaccess.com

PKG3140 0912