

SMART

Product Digest & Price List



July 15, 2019



Customer Support

Customer Care

Our Customer Service team is available to answer questions or provide any assistance you may need. You can reach them at

800-441-9692 or help@pdqlocks.com.

Monday through Friday – 8 am to 5 pm

Placing Orders

You can place your orders with PDQ Manufacturing using the email below:

Email: orders@pdqlocks.com

Product and Technical Support

866-874-3662 or support@pdqlocks.com.

Monday through Friday – 8 am to 5 pm EST.

Quotation and Cross Reference Requests

PDQ provides complete project quotation and cross reference services.

800-441-9692 or quotes@pdqlocks.com

pdqSMART Support Videos

- App set-up
- Installation
- And more



Visit the [pdqSMART YouTube Channel](#)

World Headquarters Administrative Offices U.S. Manufacturing Center

PDQ Manufacturing
2230 Embassy Drive
Lancaster, PA 17603 USA

Remittances

PDQ Manufacturing
P.O. Box 6426
Lancaster, PA 17607 USA

Regional Distribution Centers

Lancaster, PA, Norcross, GA, Kansas City, MO,
Denver, CO, Auburn, WA

International Sales Offices

Middle East – Abu Dhabi, United Arab Emirates

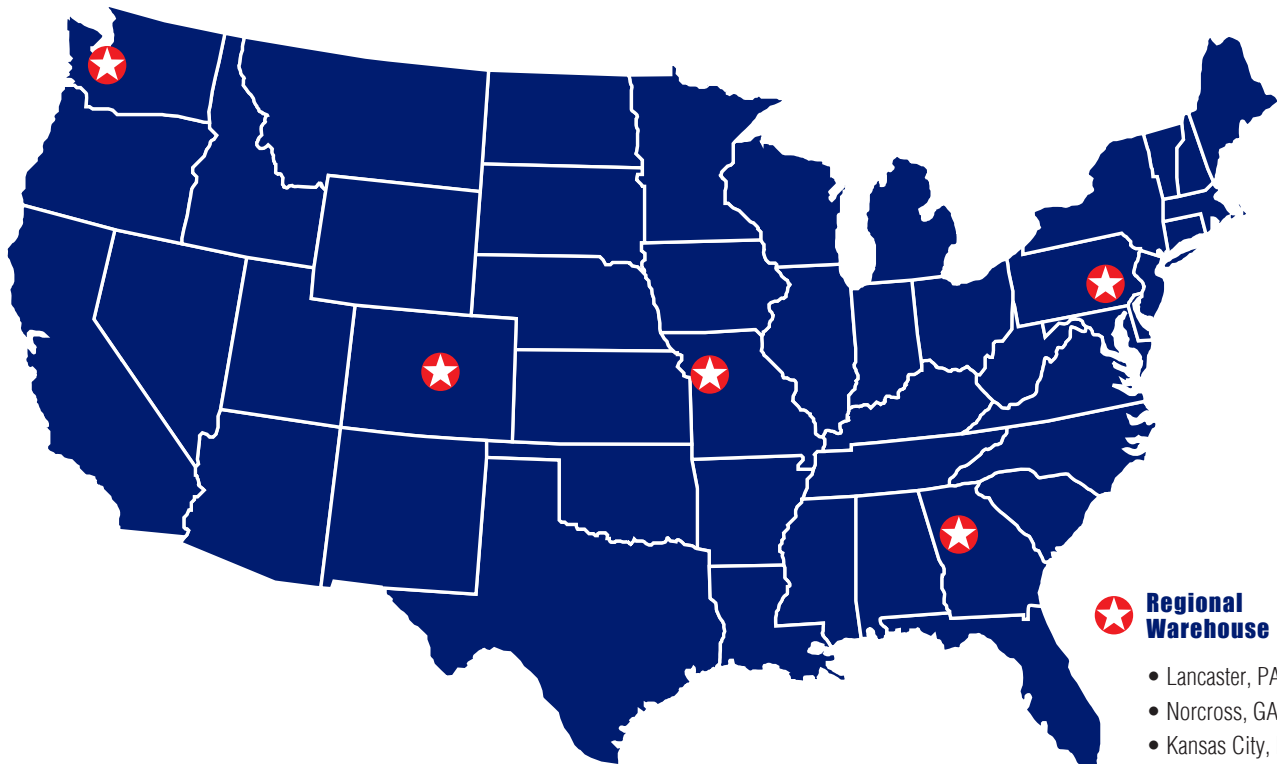

Regional Warehouse

- Lancaster, PA
- Norcross, GA
- Kansas City, MO
- Denver, CO
- Auburn, WA

<p style="text-align: center;">STP Stand-Alone Smart Touch Pin</p>	<p>MRS-STP Grade 1 Mortise 4 GTS-STP Grade 1 Cylindrical 7 6EWS-STP Exit Device Trim 10 SDS-STP Grade 2 Cylindrical 12 KMS-STP Heavy Duty Deadbolt 15 STP Accessories 17</p>
<p style="text-align: center;">STS Mobile-Based / Bluetooth Access Control</p>	<p>MRS-STS Grade 1 Mortise 19 GTS-STS Grade 1 Cylindrical 22 6EWS-STS Exit Device Trim 25 KMS-STS Heavy Duty Deadbolt 27 STS Accessories 29</p>
<p style="text-align: center;">XLS Networked Access Control</p>	<p>MRS-XLS Grade 1 Mortise 31 GTS-XLS Grade 1 Cylindrical 34 6EWS-XLS Exit Device Trim 37 SDS-XLS Grade 2 Cylindrical 39 KMS-XLS Heavy Duty Deadbolt 42 XLS Accessories 44 XLS Credentials 46 XLS Subscription and Maintenance 47</p>
<p style="text-align: center;">Product Demonstration Displays</p>	<p>Product Demonstration Displays 50</p>
<p style="text-align: center;">Key Systems, Cylinders and Keys</p>	<p>MRS-STP/STS/XLS 54 GTS-STP/STS/XLS 55 6EWS-STP/STS/XLS 57 SDS-STP/XLS 58 KMS-STP/STS/XLS 60 High Security Cylinders & Cores 62 Keying Systems 63</p>
<p style="text-align: center;">Electrified Door Hardware</p>	<p>MR199A/MR200 Grade 1 Electrified Mortise 67 XGT/GT199A Grade 1 Electrified Cylindrical 68 6200 MLR Motorized Latch Retraction 69 6200/6202 Exit Device Electrified Options 70 6EW199A Electrified Exit Device Trim 71 Electrified Hinges 74 Electric Strikes 75 Key Switches and Push Buttons 76 Power Supplies 77</p>
<p style="text-align: center;">Terms of Service</p>	<p>Terms & Conditions 79 License Agreement 80 Privacy Policy 82 Terms of Service 86 pdqSMART Warranty 92 Electrified Hardware Warranty 93</p>



Securing Confidence. Opening Possibilities.

Driven by family values and an independent spirit, PDQ has set the industry standard for service, quality and value for over 35 years. Our in-house engineering and manufacturing capabilities give us the flexibility to create innovative, cutting edge products that meet and exceed our customer's continually-evolving security and safety needs. From architectural hardware to cloud-hosted access management, PDQ prides itself on developing world-class, commercial-grade solutions that reliably deliver the confidence and control you need to effectively manage your business.



Built With Pride And The American Spirit.

Timeline of Growth and Innovations

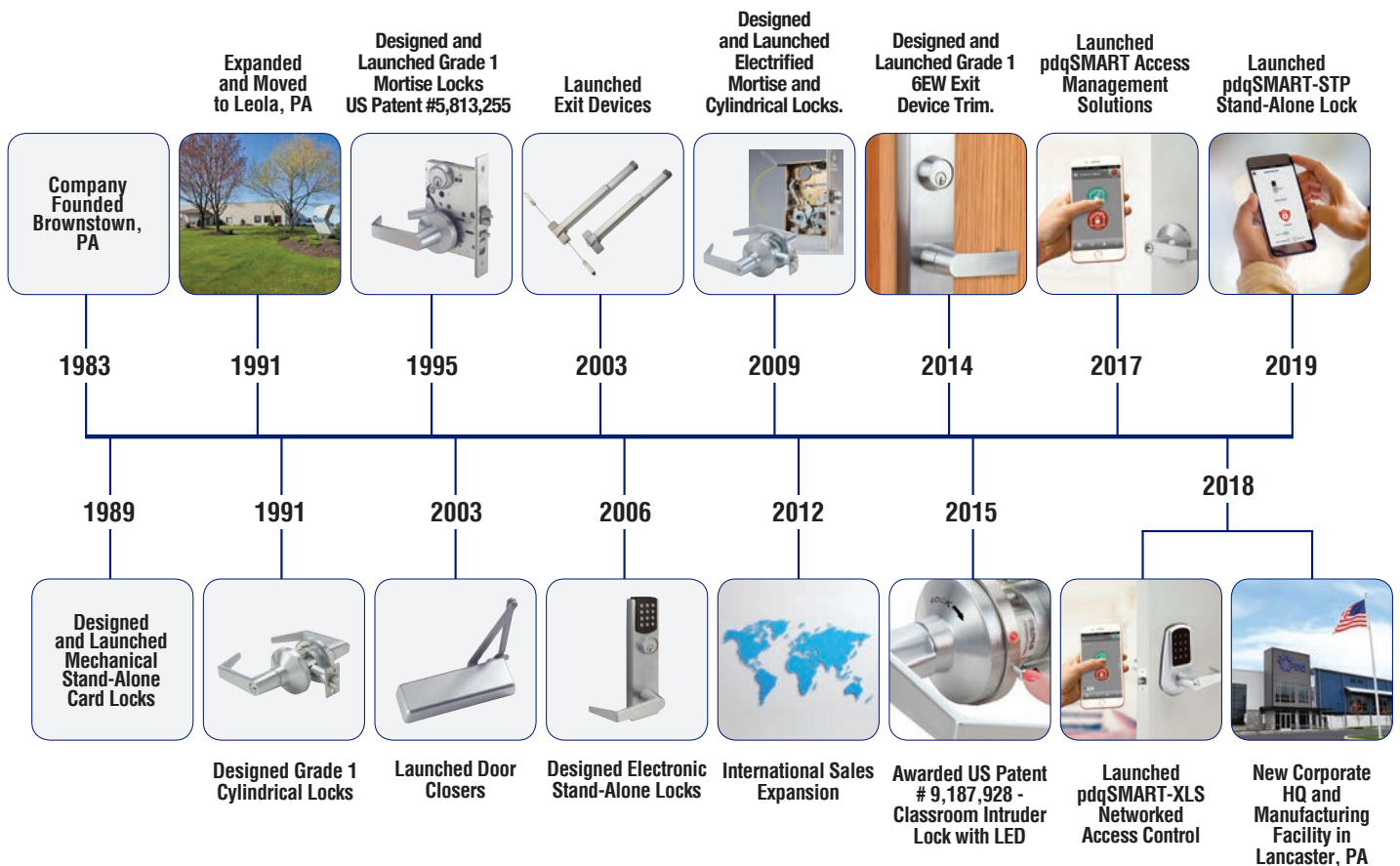



Built To Last



Strength Testing

GTS

Grade 1 Cylindrical Lock

Locked lever withstands 500 lbs of torque force



Headquarters & Manufacturing



Lancaster, PA



Durability Testing

MRS

Grade 1 Mortise Lock

11 Million lever operations equaling over 40 years of use in most facilities



Strong. Durable. Reliable. American.



PDQ Offers a Complete Line of Architectural Grade Door Hardware



Mechanical Hardware



MORTISE LOCKS



CYLINDRICAL LOCKS



DEADBOLTS



CYLINDERS



EXIT DEVICES



CLOSERS



HINGES



FLAT GOODS



GENERAL HARDWARE



SLIDING DOOR HARDWARE

Electrified Hardware



MORTISE LOCKS



CYLINDRICAL LOCKS

AND MORE

**For Pricing and Discounts
Contact Customer Service :**

**800-441-9692
help@pdqlocks.com**

INCLUDED IN THIS BOOK



Customer Buying Program



Customer Account #	Rep Agency:	Effective Date:
Customer:	Customer Contact:	
Location:	Customer Email:	

	DISCOUNT	DISCOUNT	SPECIAL	SPECIAL	FORECAST
STP PLATFORM	50/XX%	MULTIPLIER	QUANTITY	DISCOUNT	\$
Lock Devices					
KMS-STP Deadbolt					
SDS-STP Grade 2 Cylindrical					
GTS-STP Grade 1 Cylindrical					
MRS-STP Grade 1 Mortise					
6EWS-STP Exit Trim					
Accessories					
ZBRG Bridge - Ethernet					
ZECHO Range Extender					
STS PLATFORM					
Lock Devices					
MRS-STS Grade 1 Mortise					
GTS-STS Grade 1 Cylindrical					
6EWS-STS Exit Trim					
KMS-STS Deadbolt					
Accessories					
ZBOX Smart Switch					
ZTAB Android Tablet					
HCND Hybrid Cloud Device					
XLS PLATFORM					
Lock Devices					
KMS-XLS Deadbolt					
SDS-XLS Grade 2 Cylindrical					
GTS-XLS Grade 1 Cylindrical					
MRS-XLS Grade 1 Mortise					
6EWS-XLS Exit Trim					
Accessories					
HCND Hybrid Cloud Device					
ZECHO/ZECHO2 Range Extender					
ZBOX/ ZBOX2 Smart Switch					
SRAC Narrow Stile Reader (w/ PIN)					
SRAC-NP Narrow Stile Reader (w/o PIN)					
9050 Credential Enroller					
Credentials Fobs, Cards, Wearables					
ZTAB Android Tablet					

Terms: Net 30	Freight: Prepaid, added to invoice. If invoice exceeds \$1900 net, full freight deductible if paid within terms.	PDQ Mgmt Initials:
----------------------	---	---------------------------

NET/Additional Comments:

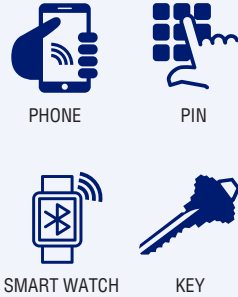
Rep Signature:	Customer Signature:	Forecast:
-----------------------	----------------------------	------------------

	CREENTIALS	HIGHLIGHTS
<h2>STP</h2> <p>Stand-Alone Smart Touch Pin</p>	 <p>PHONE PIN</p> <p>SMART WATCH KEY</p>	<ul style="list-style-type: none"> • Single door management • No hard wiring required, utilizes standard door preps • Programing done at the door by an administrator • Perfect for 1-10 door facilities • Scheduling capability for up to 100 unique users per device • Audit trail - 25 events on phone, 1 year on cloud • Upgradable to a full access control system using the same hardware • Remote operation capable with addition of optional bridge
<h2>STS</h2> <p>Mobile-Based / Bluetooth Access Control</p>	 <p>PHONE SMART WATCH</p> <p>KEY</p>	<ul style="list-style-type: none"> • Single door to multi-facility management • No hard wiring required, utilizes standard door preps • Supports 100's of devices and users • Commercial-level access control features, • Mobile management of cloud-hosted software • Remote operation capable with addition of optional bridge
<h2>XLS</h2> <p>Networked Access Control</p>	 <p>PHONE 13.56 mHZ PIN</p> <p>SMART WATCH KEY</p>	<ul style="list-style-type: none"> • Single door to multi-facility management • No hard wiring required, utilizes standard door preps • Commercial-level access control features • Scalability for 1000's of devices and users • Mobile management of cloud-hosted software • Remote operation capable

PRODUCTS

TYPICAL APPLICATIONS

COMMON USES

WORKS WITH



- Offices / Coworking Spaces
- Retail Space
- Hospitality
- Manufacturing
- Warehouses / Distribution Centers
- Mixed-Use Commercial
- Medical / Dental Clinics
- Healthcare
- Houses of Worship
- Assisted Living
- Airports and Transit Centers
- K-12 / Higher Ed / Private schools
- Institutional
- Primary Residences
- Multifamily
- Vacation Homes
- Airbnb, Rental Properties

- Entry doors
- Visitor pass through / common areas
- Vestibules or reception area doors controlled by remote release
- Pool gates, breezeways and other outdoor applications
- Maintenance areas
- Supply closets / equipment rooms
- Workout rooms
- Restrooms / bathrooms
- Dressing / fitting rooms
- Maternity / nursing rooms



- Multi-Family
- Assisted Living
- Government Facilities
- Offices
- Public Buildings
- Retail Space
- Hospitality
- Healthcare
- K-12 / Higher Ed / Private Schools
- Houses of Worship
- Industrial
- Institutional
- Manufacturing
- Warehouses / Distribution Centers

- Entry doors
- Visitor pass through / common areas
- Vestibules or reception area doors controlled by remote release
- Pool gates, breezeways and other outdoor applications
- Maintenance areas
- Supply closets / equipment rooms
- Workout rooms
- Restrooms / bathrooms
- Dressing / fitting rooms
- Maternity / nursing rooms



- Multi-Family
- Assisted Living
- Hospitality
- Offices
- Government Facilities
- Public Buildings
- Retail Space
- Healthcare
- K-12 / Higher Ed / Private Schools
- Houses of Worship
- Industrial
- Institutional
- Manufacturing
- Warehouses / Distribution Centers

- Entry doors
- Visitor pass through / common areas
- Vestibules or reception area doors controlled by remote release
- Pool gates, breezeways and other outdoor applications
- Maintenance areas
- Supply closets / equipment rooms
- Workout rooms
- Restrooms / bathrooms
- Dressing / fitting rooms
- Maternity / nursing rooms



pdq
SMART
stp

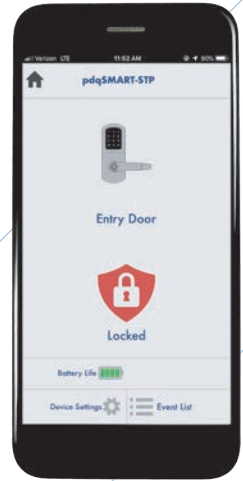

**Out With The Old.
In With The New.**



**Grade 1
Cylindrical
GTS - STP**



**Grade 2
Cylindrical
SDS - STP**



**Heavy Duty
Deadbolt
KMS - STP**



**Grade 1
Mortise
MRS - STP**



**Heavy Duty
Exit Device Trim
GEWS - STP**



STP

Stand-Alone

Smart Touch Pin



PHONE



PIN



SMART WATCH



KEY



Works with
Google Home



EFFECTIVE JULY 15, 2019

STAND-ALONE SMART TOUCH PIN



Typical Applications

- Primary Residences
- Airbnb / Vacation Homes/Vrbo
- Rental Properties
- Realtors
- Offices / Co-Working Spaces
- Small Business
- Retail
- Medical/Dental Clinics
- Daycare/Volunteer Centers
- Fitness Centers/Gyms
- Warehouses / Distribution Facilities
- Manufacturing Companies
- K-12/ Higher Ed/ Private Schools
- Houses of Worship
- Airports and Transit Centers

Multi-Credential Options

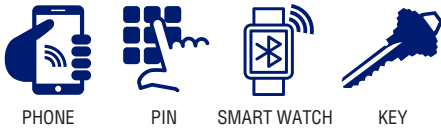

Works With



Features

- Mobile phone, smart watch, PIN, and keyed access options
- Aesthetically pleasing design to match today's smart building environments
- 100 users maximum
- 24/7 access and ability to create schedules
- Audit trail with 25 recent events locally stored on app and 1 year's worth on the cloud
- Two-factor authentication capable
- Remote operation capable with locally installed bridge device
- Powered by 4 AA alkaline batteries
- Built on the Grade 1 MR lock, tested to 11 million cycles
- Works with Alexa, Google Home, Nest cameras and other "Smart" devices
- Upgradeable to a full access control system using the existing STP lock
- Available in SFIC, Schlage LFIC, High Security and UL437 cylinders
- Keyways of other manufacturers are available
- Retrofits are easy, utilizes standard mortise door prep
- Suitable for interior and exterior applications

Lever Designs

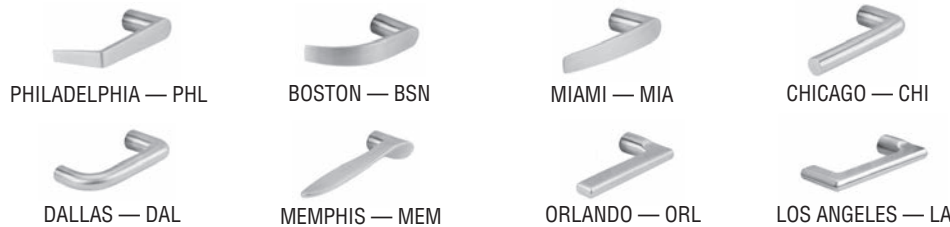

Cylinders



Rose Designs

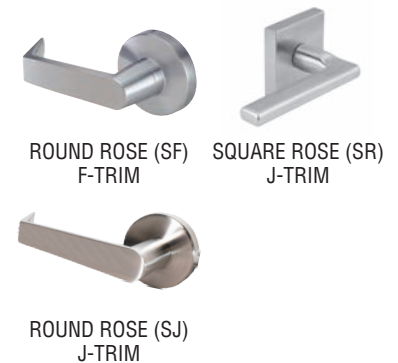

Architectural Finishes

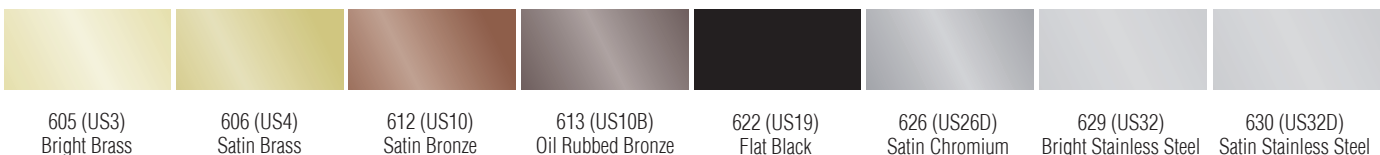

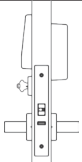
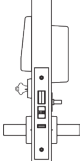

Function

FUNCTION	FUNCTION NUMBER	OUTSIDE INSIDE	DESCRIPTION
Entrance	116		<ul style="list-style-type: none"> • Outside lever always locked (factory default). • Key outside retracts latchbolt. • Outside lever is momentarily unlocked by a valid credential. • Outside lever is relocked after predetermined time as managed by the system administrator. • Outside lever can be changed to passage by the system administrator. • Inside lever always retracts the latchbolt and allows unimpeded egress.
Dormitory/Exit	136		<ul style="list-style-type: none"> • Latchbolt operated by lever from either side • Key outside extends/retracts deadbolt • Thumbturn inside extends/retracts deadbolt • Inside lever simultaneously retracts latchbolt and deadbolt • Outside lever is momentarily unlocked by a valid credential • Outside lever is relocked after predetermined time as managed by the system administrator • Outside lever can be changed to passage by the system administrator

How to Order

QTY	SERIES	FAMILY	FUNCTION	LEVER	TRIM	FINISH	HANDING	STRIKE	CYLINDER	KEYWAY	KEYING	OPTIONS
	MRS	STP	116	PJ	SJ	622	RH	ASA	D	SCC	KD	-
			136	J-TRIM PJ - PHL BJ - BSN MJ - MIA CJ - CHI DJ - DAL LJ - LA OJ - ORL KJ - K TJ - MEM F-TRIM PF - PHL BF - BSN MF - MIA	J-TRIM SJ - Sectional Round Rose SR - Sectional Square Rose F-TRIM SF - Sectional Round Rose	605 606 612 613 622 629 630	RHR LH LHR	ELS	D - Default L - Less Cylinder SF6 - SFIC w/Core, 6 Pin SF7 - SFIC w/Core, 7 Pin LF - Schlage® Compatible LFIC w/Core SFL - SFIC Housing less core LFL - Schlage® Compatible LFIC Housing less core	AR1 CO59A1 CO6 CL4 RUD SCE SCC SCC-K SAL RA-RC YA8 GA FAL KW TA A (BEST Keyway)	KD - Keyed Different KO - Zero Bitted KA - Keyed Alike KE - Keyed to Existing MK - Master Key CMK - Construction Master Key	TC1IS - Tactile Abrasive Coating - Inside only TC10S - Tactile Abrasive Coating - Outside only TC2 - Tactile Abrasive Coating - Both Sides SF - Split Finishes LL - Lead-Lined Rose DB - Dust Box AM - Antimicrobial Coating SSH - Security Head Screws ADA - Disability Thumbturn

PAGE 54

PAGE 6

List Price

	FUNCTION	DESCRIPTION	626*/630	605/606/612 613/622/629
Single Cylinder	116	Entrance	\$860.00	\$940.00
Single Cylinder w/Deadbolt	136	Dormitory/Exit	\$940.00	\$1020.00

*626 available in F Trim only

MRS-STP MORTISE LOCKS

LIST PRICE

Effective July 15, 2019

Options

CODE	DESCRIPTION	LOCK ADJUSTMENT
TC1IS	Tactile Abrasive Coating - Inside only (PHL and MIA levers only)	\$43.00
TC1OS	Tactile Abrasive Coating - Outside only (PHL and MIA levers only)	
TC2	Tactile Abrasive Strip - Both Sides (PHL and MIA levers only)	\$306.00
LL	Lead-wrapped Case	\$86.00
SHS	Security Head Screws	\$26.00
SF	Split Finishes	Higher of 2 Finishes
AM*	Antimicrobial Coating - Sectional Mortise Lock inside lever, rose, thumbturn, outside lever	\$60.00
ADA	Disability Turn (ADA) - for J Trim Only	\$18.00
DB	Dust Box	\$4.00

*Parts discount applies



ADA Thumbturn

Configurations

CYLINDERS	PAGE 54
CORES	PAGE 54
KEYWAYS	PAGE 54
HIGH SECURITY CYLINDERS	PAGE 62
KEYING SYSTEMS	PAGE 63

EFFECTIVE JULY 15, 2019

STAND-ALONE SMART TOUCH PIN



Typical Applications

- Primary Residences
- Airbnb / Vacation Homes / Vrbo
- Rental Properties
- Realtors
- Offices / Co-Working Spaces
- Small Business
- Retail
- Medical / Dental Clinics
- Daycare / Volunteer Centers
- Fitness Centers / Gyms
- Warehouses / Distribution Facilities
- Manufacturing Companies
- K-12 / Higher Ed / Private Schools
- Houses of Worship
- Airports and Transit Centers

Multi-Credential Options

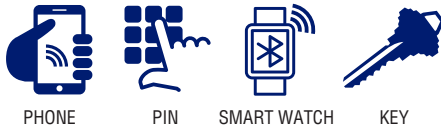

Works With



EXTERIOR VIEW

Features

- Mobile phone, smart watch, PIN, and keyed access options
- Aesthetically pleasing design to match today's smart building environments
- 100 users maximum
- 24/7 access and ability to create schedules
- Audit trail with 25 recent events locally stored on app and 1 year's worth on the cloud
- Two-factor authentication capable
- Remote operation capable with locally installed bridge device
- Powered by 4 AA alkaline batteries
- Built on the Grade 1 GT lock, tested to 3 million cycles and torque resistant to 2,200 in-lbs
- Works with Alexa, Google Home, Nest cameras and other "Smart" devices
- Upgradeable to a full access control system using the existing STP lock
- Available in Conventional, SFIC, Schlage LFIC, High Security and UL437 cylinders
- Keyways of other manufacturers are available
- Retrofits are easy, utilizes standard 161 door prep
- Suitable for interior and exterior applications



INTERIOR VIEW

Lever Designs



PHILADELPHIA — PHL

BOSTON — BSN

MIAMI — MIA

Cylinders



Architectural Finishes



606 (US4)
Satin Brass

612 (US10)
Satin Bronze

613 (US10B)
Oil Rubbed Bronze

622 (US19)
Flat Black

626 (US26D)
Satin Chromium

GTS-STP CYLINDRICAL LOCKS

LIST PRICE

Effective July 15, 2019

Function

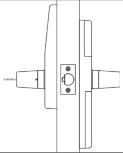
FUNCTION	FUNCTION NUMBER	OUTSIDE INSIDE	DESCRIPTION
Entrance	116		<ul style="list-style-type: none"> • Outside lever always locked (factory default). • Outside lever is momentarily unlocked by a valid credential or by key. • Outside lever is relocked after predetermined time as managed by the authorized credential holder. • Outside lever can be changed to passage by authorized credential holder. • Inside lever always retracts the latchbolt and allows unimpeded egress.

How to Order



QTY	SERIES	FAMILY	FUNCTION	TRIM	FINISH	HANDING	BACKSET	STRIKE	CYLINDER	KEYWAY	KEYING	OPTIONS
	GTS	STP	116	PHL	626	RH	234	ASA	D	SCC	KD	—
				BOS	606	LH	234 - 2-3/4" (default) 5 - 5" PAGE 55	ASA - ANSI/ASA (default) FL - Full Lip T - "T" Strike PAGE 55	D - Default L - Less Cylinder SF6 - SFIC w/Core, 6 Pin SF7 - SFIC w/Core, 7 Pin LF - Schlage® Compatible LFIC w/Core SFL - SFIC Housing less core LFL - Schlage® Compatible LFIC Housing less core55 PAGE 55	AR1 C059A1 C06 CL4 RUD SCE SCC SCC-K SAL RA-RC YA8 GA FAL KW TA A PDQ1 PDQ2 PDQ3 PAGE 55	KD - Keyed Different KO - Zero Bitted KA - Keyed Alike KE - Keyed to Existing MK - Master Key CMK - Construction Master Key BEST Keyways	TC10S - Tactile Abrasive Coating - Outside only TC2 - Tactile Abrasive Coating - Both Sides SF - Split Finishes LL - Lead-Lined Rose DB - Dust Box AM - Antimicrobial Coating PAGE 9
			MIA	612								
				613								
				622								

List Price

	FUNCTION	DESCRIPTION	626	606/612/613/622
Single Cylinder	116	Entrance	\$650.00	\$730.00

Options

CODE	DESCRIPTION	LOCK ADJUSTMENT
TC10S	Tactile Abrasive Coating - Outside only	\$43.00
TC2	Tactile Abrasive Coating - Both Sides	\$86.00
LL	Lead-Lined Rose	\$346.00
DB	Dust Box	\$4.00
SF	Split Finishes	Higher of 2 Finishes
AM*	Antimicrobial Coating, Lever Set Includes Inside and Outside Lever and Rose	\$62.00

*Parts discount applies

Configurations

BACKSET	PAGE 55
STRIKES	PAGE 55
CYLINDERS	PAGE 55
KEYWAYS	PAGE 55
CORES	PAGE 56
HIGH SECURITY CYLINDERS	PAGE 62
KEYING SYSTEMS	PAGE 63

EFFECTIVE JULY 15, 2019

STAND-ALONE SMART TOUCH PIN

MADE IN THE USA 

Typical Applications

- Offices
- Co-Working Spaces
- Small Business
- Retail
- Medical and Dental Clinics
- Fitness Centers and Gyms
- Warehouses/ Distribution Facilities
- Manufacturing Companies
- K-12/ Higher Ed/ Private Schools
- Houses of Worship
- Airports and Transit Centers
- Daycare/ Volunteer Centers

Multi-Credential Options

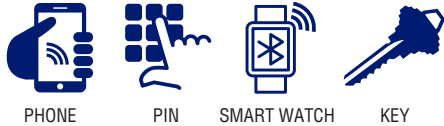

Features

- Mobile phone, smart watch, PIN, and keyed access options
- Aesthetically pleasing design to match today's smart building environments
- 100 users maximum
- 24/7 access and ability to create schedules
- Audit trail with 25 recent events locally stored on app and 1 year's worth on the cloud
- Two-factor authentication capable
- Remote operation capable with locally installed bridge device
- Powered by 4 AA alkaline batteries
- Built on PDQ's World-Class 6EW Heavy Duty Exit Device Trim
- Retrofits Von Duprin 98/99 and other major brands.
- Available in Conventional, SFIC, Schlage LFIC, High Security and UL437 cylinders
- Keyways of other manufacturers are available
- Suitable for interior and exterior applications



Cylinders



Lever Designs



Architectural Finishes

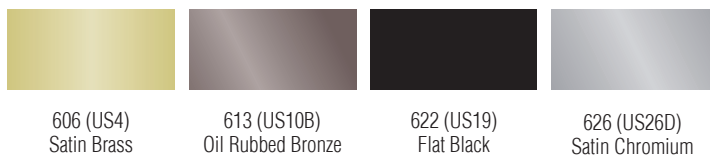

6EWS-STP EXIT DEVICE TRIM

LIST PRICE

Effective July 15, 2019

pdqSMART-STP
STAND-ALONE KEYLESS SMART LOCKING SOLUTION

How to Order

QTY	SERIES	FAMILY	LEVER	TRIM	FINISH	HANDING	CYLINDER	KEYWAY	KEYING	OPTIONS
	6EWS	STP	PHL BOS CHI MIA ORL	—	626 606 613 622	LHR RHR	D L - Less Cylinder SF6 - SFIC w/ Core, 6 Pin SF7 - SFIC w/ Core, 7 Pin LF - Schlage® Compatible LFIC w/Core SFL - SFIC Housing less core LFL - Schlage® Compatible LFIC Housing less core	SCC AR1 C059A1 C06 CL4 RUD SCE SCC SCC-K SAL RA-RC YA8 GA FAL KW TA A (Best Keyways)	KD KD - Keyed Different KO - Zero Bitted KA - Keyed Alike KE - Keyed to Existing MK - Master Key CMK - Construction Master Key	— AM - Antimicrobial Coating VD1 - Adapts 6EWS Trim and 6200R/V/CV exit device to fit existing Von Duprin 98/99 door prep. VD2 - Adapts 6EWS Trim to fit existing Von Duprin 98/99 exit device. PRI - Adapts 6EWS Trim to fit existing Precision 2100 Device. YC1 - Adapts 6EWS Trim to fit existing Yale 7000 or Corbin Russwin ED5000 Device. DK1 - Adapts 6EWS Trim to fit existing Dorma 9300 Device.



List Price

DESCRIPTION	626	606/613/622
6EWS-STP	\$1005.00	\$1035.00

Options

CODE	DESCRIPTION	TRIM ADJUSTMENT
AM*	Antimicrobial coating applied to tactile surfaces	\$162.00
VD1	6EWS Trim and 6200R/V/CV exit device adapted to fit existing Von Duprin 98/99 door prep.	N/C
VD2	6EWS Trim adapted to fit existing Von Duprin 98/99 Device.	\$50.00
PR1	6EWS Trim adapted to fit existing Precision 2100 Device.	\$50.00
YC1	6EWS Trim adapted to fit existing Yale 7000 or Corbin Russwin ED5000 Device.	\$50.00
DK1	6EWS Trim adapted to fit existing Dorma 9300 Device.	\$50.00

*Parts discount applies

Configurations

CYLINDERS	PAGE 57
CORES	PAGE 57
KEYWAYS	PAGE 57
HIGH SECURITY CYLINDERS	PAGE 62
KEYING SYSTEMS	PAGE 63

EFFECTIVE JULY 15, 2019

STAND-ALONE SMART TOUCH PIN



Typical Applications

- Primary Residences
- Airbnb / Vacation Homes/Vrbo
- Rental Properties
- Realtors
- Offices / Co-Working Spaces
- Small Business
- Retail
- Medical/Dental Clinics
- Daycare/Volunteer Centers
- Fitness Centers/Gyms
- Warehouses / Distribution Facilities
- Manufacturing Companies
- K-12/ Higher Ed/ Private Schools
- Houses of Worship
- Airports and Transit Centers

Multi-Credential Options

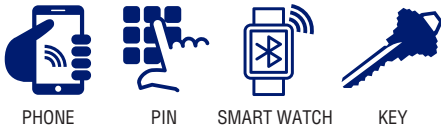

Works With



EXTERIOR VIEW

Features

- Mobile phone, smart watch, PIN, and keyed access options
- Aesthetically pleasing design to match today's smart building environments
- 100 users maximum
- 24/7 access and ability to create schedules
- Audit trail with 25 recent events locally stored on app and 1 year's worth on the cloud
- Two-factor authentication capable
- Remote operation capable with locally installed bridge device
- Powered by 4 AA alkaline batteries
- Built on the Grade 2 SD mechanical chassis
- Works with Alexa, Google Home, Nest cameras and other "Smart" devices
- Upgradeable to a full access control system using the existing STP lock
- Available in Conventional, SFIC, High Security and UL437 cylinders and keyways of other manufacturers
- Retrofits are easy, utilizes standard 161 door prep
- Suitable for interior and exterior applications, interior and exterior weatherized gaskets are standard.



INTERIOR VIEW

Lever Designs



PHILADELPHIA — PHL



BOSTON — BSN



MIAMI — MIA



MEMPHIS — MEM



ORLANDO — ORL

Cylinders



Architectural Finishes



605 (US3)
Bright Brass

613 (US10B)
Oil Rubbed Bronze

626 (US26D)
Satin Chromium

SDS-STP CYLINDRICAL LOCKS

LIST PRICE

Effective July 15, 2019

pdqSMART-STP
STAND-ALONE KEYLESS SMART LOCKING SOLUTION

Function

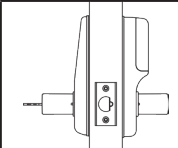
FUNCTION	FUNCTION NUMBER	OUTSIDE INSIDE	DESCRIPTION
Entrance	116		<ul style="list-style-type: none"> • Outside lever always locked (factory default). • Outside lever is momentarily unlocked by a valid credential or by key. • Outside lever is relocked after predetermined time as managed by the authorized credential holder. • Outside lever can be changed to passage by authorized credential holder. • Inside lever always retracts the latchbolt and allows unimpeded egress.

How to Order

QTY	SERIES	FAMILY	FUNCTION	TRIM	FINISH	HANDING	BACKSET	STRIKE	CYLINDER	KEYWAY	KEYING	OPTIONS
	SDS	STP	116	PHL BOS MIA ORL MEM	626 605 613	RH LH	234 234F - 2-3/4" Fire Rated Latch 234FR - 2-3/4" Fire Rated Latch, Radius 238 - 2-3/8" 238F - 2-3/8" Fire Rated Latch 238FR - 2-3/8" Fire Rated Latch, Radius	ASA ASA - ANSI/ASA (default) FL - Full Lip T - "T" Strike	D D - Default L - Less Cylinder SF6 - SFIC w/Core, 6 Pin SF7 - SFIC w/Core, 7 Pin SFL - SFIC Housing less core	SCC AR1 C059A1 C06 CL4 RUD SCE SCC SCC-K SAL RA-RC YA8 GA FAL KW TA A (BEST Keyways) PDQ1 PDQ2 PDQ3	KD KD - Keyed Different KO - Zero Bitted KA - Keyed Alike KE - Keyed to Existing MK - Master Key CMK - Construction Master Key	— TC1IS - Tactile Abrasive Coating - Inside only TC10S - Tactile Abrasive Coating - Outside only TC2 - Tactile Abrasive Coating - Both Sides DB - Dust Box AM - Antimicrobial Coating
							PAGE 58	PAGE 58	PAGE 59			PAGE 14
												PAGE 59



List Price

	FUNCTION	DESCRIPTION	626	605/613
Single Cylinder	116	Entrance	\$485.00	\$515.00

SDS-STP CYLINDRICAL LOCKS

LIST PRICE

Effective July 15, 2019

Options

CODE	DESCRIPTION	LOCK ADJUSTMENT
TC1IS	Tactile Abrasive Coating - Inside only	\$43.00
TC1OS	Tactile Abrasive Coating - Outside only	
TC2	Tactile Abrasive Coating - Both Sides	\$86.00
DB	Dust Box	\$4.00
AM*	Antimicrobial Coating, Lever Set Includes Inside and Outside Lever and Rose	\$62.00

*Parts discount applies

Configurations

BACKSET	PAGE 58
STRIKES	PAGE 58
CYLINDERS	PAGE 59
CORES	PAGE 59
KEYWAYS	PAGE 59
HIGH SECURITY CYLINDERS	PAGE 62
KEYING SYSTEMS	PAGE 63

EFFECTIVE JULY 15, 2019

STAND-ALONE SMART TOUCH PIN



Typical Applications

- Primary Residences
- Airbnb / Vacation Homes / Vrbo
- Rental Properties
- Realtors
- Offices / Co-Working Spaces
- Small Business
- Retail
- Medical / Dental Clinics
- Daycare / Volunteer Centers
- Fitness Centers / Gyms
- Warehouses / Distribution Facilities
- Manufacturing Companies
- K-12 / Higher Ed / Private Schools
- Houses of Worship
- Airports and Transit Centers

Multi-Credential Options

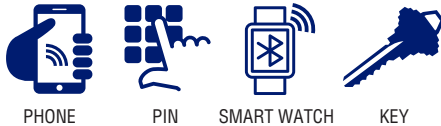

Works With



EXTERIOR VIEW

Features

- Mobile phone, smart watch, PIN, and keyed access options
- Aesthetically pleasing design to match today's smart building environments
- 100 users maximum
- 24/7 access and ability to create schedules
- Audit trail with 25 recent events locally stored on app and 1 year's worth on the cloud
- Two-factor authentication capable
- Remote operation capable with locally installed bridge device
- Powered by 4 AA alkaline batteries
- Built from KM Heavy Duty Deadbolts
- Works with Alexa, Google Home, Nest cameras and other "Smart" devices
- Upgradeable to a full access control system using the existing STP lock
- Available in conventional and SFIC cylinder format
- Keyways of other manufacturers are available
- Retrofits are easy, utilizes standard deadbolt prep
- Suitable for interior and exterior applications
- Uses conventional KIK cylinder



INTERIOR VIEW

Architectural Finishes



605 (US3)
Bright Brass

613 (US10B)
Oil Rubbed Bronze

622 (US19)
Flat Black

626 (US26D)
Satin Chromium

Cylinders



KMS-STP HEAVY DUTY DEADBOLT

LIST PRICE

Effective July 15, 2019

Function

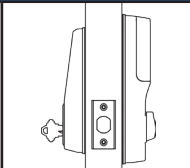
FUNCTION	FUNCTION NUMBER	OUTSIDE INSIDE	DESCRIPTION
Single Cylinder	116		<ul style="list-style-type: none"> Lock or unlock by key from outside, by thumb turn from inside

How to Order

QTY	SERIES	FAMILY	FUNCTION	FINISH	HANDING	BACKSET	STRIKE	CYLINDER	KEYWAY	KEYING
	KMS	STP	116	626	RH	ADJ	DB	D	SCC	KD
				605*	LH	234 - 2-3/4"		D - Default	KW	KD - Keyed Different
				613		238 - 2-3/8"		L - Less Cylinder	PAGE 61	KO - Zero Bitted
				622		ADJ - Adjustable 2-3/4" - 2-3/8"		SF6 - SFIC w/Core, 6 Pin		KA - Keyed Alike
						ADJR - Adjustable 2-3/4" - 2-3/8" Radius		SF7 - SFIC w/Core, 7 Pin		KE - Keyed to Existing
								SF7L - SFIC 7 Pin Housing, Less Core		MK - Master Key
								SF6L - SFIC 6 Pin Housing, Less Core		CMK - Construction Master Key
						PAGE 60				
									PAGE 61	



Configurations

BACKSET	PAGE 60
CYLINDERS	PAGE 61
CORES	PAGE 61
KEYWAYS	PAGE 61
HIGH SECURITY CYLINDERS	PAGE 62
KEYING SYSTEMS	PAGE 63

List Price

	FUNCTION	DESCRIPTION	626	605* 613/622
Single Cylinder	116	Entrance	\$410.00	\$430.00

*Contact factory for lead time

Ethernet Bridge



ETHERNET BRIDGE
Used for Remote Lock/Unlock

Range Extender

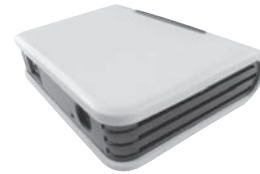

RANGE EXTENDER

How to Order

QTY	DESCRIPTION	PART NUMBER	LIST
	Ethernet Bridge	ZBRG	\$560.00

How to Order

QTY	DESCRIPTION	PART NUMBER	LIST
	Range Extender	ZECHO	\$520.00

SMART

STS

Mobile-Based Bluetooth Access Control



PHONE



SMART WATCH



KEY



Works with
Google Home



EFFECTIVE JULY 15, 2019

Cloud Hosted Access Management Solution

MOBILE-BASED/BLUETOOTH ACCESS CONTROL

Typical Applications

- Assisted living
- Churches
- Government facilities
- Healthcare
- Hospitality
- Industrial
- K-12, higher education
- Multi-family
- Offices
- Public buildings
- Retail

MADE IN THE USA

Credentials



Works With



Features

- Built from PDQ's World-Class MR Series Grade 1 Mortise Lock.
- Designed for quick installation. Fits standard ANSI/BHMA A156.115 Door Prep for Mortise Locks.
- Built in Bluetooth connects to your Bluetooth BLE enabled smart phone or tablet.
- NSA level security. Equipped with multi-layer door to cloud data security utilizing AES-128 bit encryption for over-the-air transmissions.
- Key override function: MRS 116 Entrance (default).
- Locking function can be changed to Passage by an authorized credential holder.
- Levers are non-handed.
- For doors: 1-3/4" to 2-1/4" thick.
- Key Systems: Compatible with BEST[®], Schlage[®] and most other major manufacturers.



Cylinders



Performance

- Independently tested by Intertek to over 11 million cycles (11 times the ANSI/BHMA Grade 1 standard).

Lever Designs

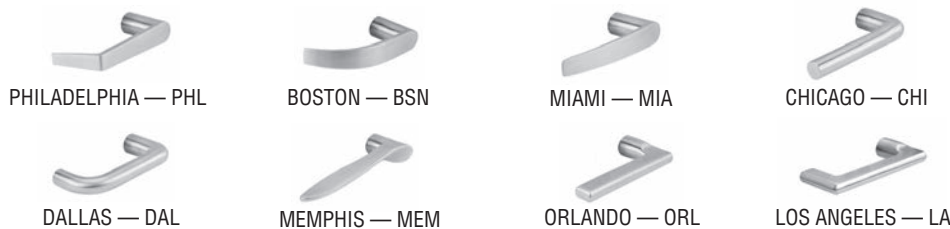

Rose Designs

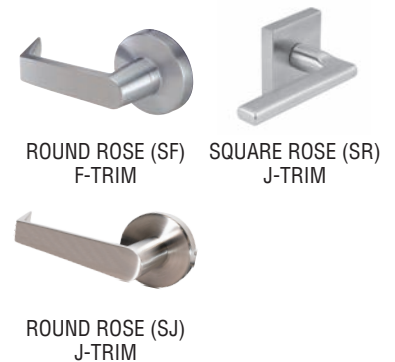

Architectural Finishes

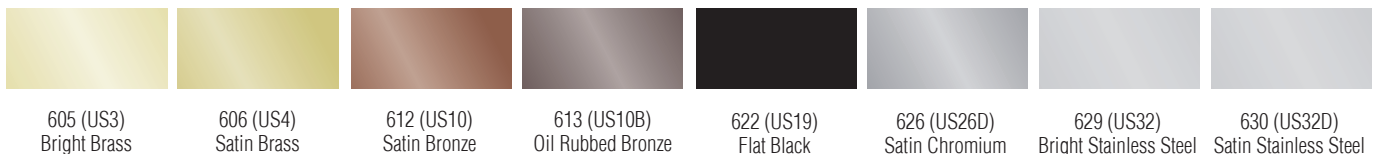

MRS-STS MORTISE LOCKS

LIST PRICE

Effective July 15, 2019

Function

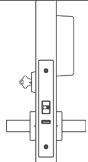
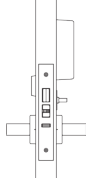
FUNCTION	FUNCTION NUMBER	OUTSIDE INSIDE	DESCRIPTION
Entrance	116		<ul style="list-style-type: none"> • Outside lever always locked (factory default). • Key outside retracts latchbolt. • Outside lever is momentarily unlocked by a valid credential. • Outside lever is relocked after predetermined time as managed by the system administrator. • Outside lever can be changed to passage by the system administrator. • Inside lever always retracts the latchbolt and allows unimpeded egress.
Dormitory/Exit	136		<ul style="list-style-type: none"> • Latchbolt operated by lever from either side • Key outside extends/retracts deadbolt • Thumbturn inside extends/retracts deadbolt • Inside lever simultaneously retracts latchbolt and deadbolt • Outside lever is momentarily unlocked by a valid credential • Outside lever is relocked after predetermined time as managed by the system administrator • Outside lever can be changed to passage by the system administrator

How to Order

QTY	SERIES	FAMILY	FUNCTION	LEVER	TRIM	FINISH	HANDING	BACKSET	STRIKE	CYLINDER	KEYWAY	KEYING	OPTIONS
	MRS	STS	116	PJ	SJ	622	RH	234	ASA	D	SCC	KD	TCIIS
			136	J-TRIM PJ - PHL BJ - BSN MJ - MIA CJ - CHI DJ - DAL LJ - LA OJ - ORL KJ - K TJ - MEM F-TRIM PF - PHL BF - BSN MF - MIA	J-TRIM SJ - Sectional Round Rose SR - Sectional Square Rose F-TRIM SF - Sectional Round Rose	605 606 612 613 622 626 629 630	RHR LH LHR	234 - 2-3/4" (default)	ASA - ANSI/ASA (default)	D - Default L - Less Cylinder SF6 - SFIC w/Core, 6 Pin SF7 - SFIC w/Core, 7 Pin LF - Schlage® Compatible LFIC w/Core SFL - SFIC Housing less core LFL - Schlage® Compatible LFIC Housing less core	AR1 C059A1 C06 CL4 RUD SCE SCC SCC-K SAL RA-RC YA8 GA FAL KW TA NON	KD - Keyed Different KO - Zero Bitted KA - Keyed Alike KE - Keyed to Existing MK - Master Key CMK - Construction Master Key	TC11S - Tactile Abrasive Coating - Inside only TC10S - Tactile Abrasive Coating - Outside only TC2 - Tactile Abrasive Coating - Both Sides SF - Split Finishes LL - Lead-Lined Rose DB - Dust Box AM - Antimicrobial Coating SSH - Security Head Screws ADA - Disability Thumbturn



PAGE 54

PAGE 21

List Price

	FUNCTION	DESCRIPTION	626*/630	605/606/612 613/622/629
Single Cylinder	116	Entrance	\$800.00	\$880.00
Double Cylinder w/Deadbolt	136	Dormitory/Exit	\$880.00	\$960.00

*626 available in F Trim only

Options

CODE	DESCRIPTION	LOCK ADJUSTMENT
TC1IS	Tactile Abrasive Coating - Inside only (PHL and MIA levers only)	\$43.00
TC1OS	Tactile Abrasive Coating - Outside only (PHL and MIA levers only)	
TC2	Tactile Abrasive Strip - Both Sides (PHL and MIA levers only)	\$306.00
LL	Lead-wrapped Case	\$86.00
SHS	Security Head Screws	\$26.00
SF	Split Finishes	Higher of 2 Finishes
AM*	Antimicrobial Coating - Sectional Mortise Lock inside lever, thumbturn, outside lever	\$60.00
ADA	Disability Turn (ADA) - for J Trim Only	\$52.00
DB	Dust Box	\$4.00



ADA Thumbturn

*Parts discount applies

Configurations

CYLINDERS	PAGE 54
CORES	PAGE 54
KEYWAYS	PAGE 54
HIGH SECURITY CYLINDERS	PAGE 62
KEYING SYSTEMS	PAGE 63

EFFECTIVE JULY 15, 2019

Cloud Hosted Access Management Solution

MOBILE-BASED/BLUETOOTH ACCESS CONTROL

Typical Applications

- Churches
- Federal and state government
- Healthcare
- Hospitality
- Industrial
- K-12, higher education
- Offices
- Public buildings

MADE IN THE USA

Credentials



PHONE



SMART WATCH



KEY

Works With



Features

- Built from PDQ's World-Class GT Series Grade 1 Cylindrical Lock.
- Designed for quick installation. Fits standard 161 door prep.
- Built in Bluetooth connects to your Bluetooth BLE enabled smart phone or tablet.
- NSA level security. Equipped with multi-layer door to cloud data security utilizing AES-128 encryption for over-the-air transmissions.
- Key override function: GTS 116 Entrance (default).
- Locking function can be changed to Passage by an authorized credential holder.
- Levers are non-handed. Default handing for the Electronics Package: Right Hand. Handing is easily changeable in the field to Left Hand. Handing can also be specified and ordered from the factory. See How to Order Guide.
- For doors: 1-3/4" to 2-1/4" thick.
- Key Systems: Compatible with BEST®, Schlage® and most other major manufacturers.



EXTERIOR VIEW

Performance

- Independently tested to over 3 million cycles (3 times the ANSI/BHMA Grade 1 standard).
- Lever torque resistance independently tested to over 2,100 in-lbs (3 times the ANSI/BHMA Grade 1 standard).

Lever Designs



PHILADELPHIA — PHL



BOSTON — BSN



MIAMI — MIA



INTERIOR VIEW

Architectural Finishes



606 (US4)
Satin Brass



612 (US10)
Satin Bronze



613 (US10B)
Oil Rubbed Bronze



619 (US15)
Satin Nickel



622 (US19)
Flat Black



626 (US26D)
Satin Chromium

Cylinders



GTS-STC CYLINDRICAL LOCK

LIST PRICE

Effective July 15, 2019

Function

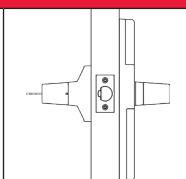
FUNCTION	FUNCTION NUMBER	OUTSIDE INSIDE	DESCRIPTION
Entrance	116		<ul style="list-style-type: none"> • Outside lever always locked (factory default). • Outside lever is momentarily unlocked by a valid credential or by key. • Outside lever is relocked after predetermined time as managed by the authorized credential holder. • Outside lever can be changed to passage by authorized credential holder. • Inside lever always retracts the latchbolt and allows unimpeded egress.

How to Order

QTY	SERIES	FAMILY	FUNCTION	TRIM	FINISH	HANDING	BACKSET	STRIKE	CYLINDER	KEYWAY	KEYING	OPTIONS
	GTS	STS	116	PHL	626	RH	234	ASA	D	SCC	KD	—
				BOS	606	LH	234 - 2-3/4" (default)	ASA - ANSI/ASA (default)	L - Less Cylinder	AR1	KD - Keyed Different	TC11S - Tactile Abrasive Coating - Inside only
				MIA	612		5 - 5"	FL - Full Lip	SF6 - SFIC w/Core, 6 Pin	C059A1	KO - Zero Bitted	TC10S - Tactile Abrasive Coating - Outside only
					613		PAGE 55	T - "T" Strike	SF7 - SFIC w/Core, 7 Pin	C06	KA - Keyed Alike	TC2 - Tactile Abrasive Coating - Both Sides
					619			PAGE 55	LF - Schlage® Compatible LFIC w/Core	RUD	KE - Keyed to Existing	LL - Lead-Lined Rose
					622				SFL - SFIC Housing less core	SCE	MK - Master Key	DB - Dust Box
									LFL - Schlage® Compatible LFIC Housing less core	SCC-K	CMK - Construction Master Key	AM - Antimicrobial Coating
										SAL		PAGE 24
										RA-RC		
										YA8		
										GA		
										FAL		
										KW		
										TA		
										A (Best Keyways)		
										PAGE 55		
										PDQ1		
										PDQ2		
										PDQ3		
										PAGE 55		



FUNCTION - 116A



FUNCTION - 116

List Price

FUNCTION	DESCRIPTION	626	606/612/613/619/622
116A*	Entrance	\$440.00	
116	Entrance	\$560.00	\$640.00

*Limited bridge operation range

GTS-STS CYLINDRICAL LOCK

LIST PRICE

Effective July 15, 2019

Options

CODE	DESCRIPTION	LOCK ADJUSTMENT
TC1IS	Tactile Abrasive Coating - Inside only	\$43.00
TC1OS	Tactile Abrasive Coating - Outside only	\$43.00
TC2	Tactile Abrasive Coating - Both Sides	\$86.00
LL	Lead-Lined Rose	\$346.00
DB	Dust Box	\$4.00
AM*	Antimicrobial Coating, Lever Set Includes Inside and Outside Lever and Rose	\$62.00

*Parts discount applies

Configurations

BACKSET	PAGE 55
STRIKES	PAGE 55
CYLINDERS	PAGE 55
KEYWAYS	PAGE 55
CORES	PAGE 56
HIGH SECURITY CYLINDERS	PAGE 62
KEYING SYSTEMS	PAGE 63

EFFECTIVE JULY 15, 2019

Cloud Hosted Access Management Solution

MOBILE-BASED/BLUETOOTH ACCESS CONTROL

Typical Applications

- Assisted living
- Churches
- Government facilities
- Healthcare
- Hospitality
- Industrial
- K-12, higher education
- Multi-family
- Offices
- Pairs of doors
- Public buildings
- Retail
- Single exterior and interior doors

MADE IN THE USA



Credentials



PHONE



SMART WATCH



KEY

Works With



Works with Google Home

Features

- Built from PDQ's World-Class 6 EW Series Exit Device Trim.
- For use with PDQ's 6200 Series RIM, Surface Vertical Rod and Concealed Vertical Rod Exit Devices.
- Connects to Bluetooth BLE enabled smart phones or tablets.
- NSA level security. Equipped with multi-layer door to cloud data security utilizing AES-128 encryption for over-the-air transmissions.
- Designed for quick installation. Fits standard 6 EW door prep. One additional hole required.
- Electronics Package features the PdqSMART PC Board and Battery Pack securely located in the exit device. Note: "AL" Alarm options and "MLR" Motorized Latch Retraction options are not available with the exit device when paired with the 6 EWS trim.
- Electronics Package available as a KIT for field retro-fit with a 6200 series exit device or supplied with the electronics package factory installed. See How to Order Guide.
- Key override function: ANSI/BHMA 09 Storeroom (default).
- Locking function can be changed to Passage by an authorized credential holder.
- All levers field handed.
- For doors: 1-3/4" to 2" thick.
- Key Systems: Compatible with BEST[®], Schlage[®] and most other major manufacturers.



Lever Designs



PHILADELPHIA — PHL



BOSTON — BSN



CHICAGO — CHI



MIAMI — MIA



ORLANDO — ORL

Cylinders



Architectural Finishes



606 (US4)
Satin Brass



612 (US10)
Satin Bronze



613 (US10B)
Oil Rubbed Bronze



619 (US15)
Satin Nickel



626 (US26D)
Satin Chromium

6EWS-STS EXIT DEVICE TRIM

LIST PRICE

Effective July 15, 2019

How to Order

QTY	SERIES	FAMILY	LEVER	TRIM	FINISH	HANDING	CYLINDER	KEYWAY	KEYING	OPTIONS
	6EWS	STS	PHL	ESC	626	LHR	D	SCC	KD	—
			BOS		606	RHR	D - Default L - Less Cylinder SF6 - SFIC w/ Core, 6 Pin SF7 - SFIC w/ Core, 7 Pin LF - Schlage® Compatible LFIC w/Core SFL - SFIC Housing less core LFL - Schlage® Compatible LFIC Housing less core	AR1 C059A1 C06 CL4 RUD SCE SCC SCC-K SAL RA-RC YA8 GA FAL KW TA	KD - Keyed Different KO - Zero Bitted KA - Keyed Alike KE - Keyed to Existing MK - Master Key CMK - Construction Master Key	AM - Antimicrobial Coating VD1 - Adapts 6EWS Trim and 6200R/V/CV exit device to fit existing Von Duprin 98/99 door prep. VD2 - Adapts 6EWS Trim to fit existing Von Duprin 98/99 exit device. PRI - Adapts 6EWS Trim to fit existing Precision 2100 Device. YC1 - Adapts 6EWS Trim to fit existing Yale 7000 or Corbin Russwin ED5000 Device. DK1 - Adapts 6EWS Trim to fit existing Dorma 9300 Device.
			CHI		612					
			MIA		613					
			ORL		619					



List Price

DESCRIPTION	626	606/613/619/622
6EWS-STS	\$890.00	\$920.00

Options

CODE	DESCRIPTION	TRIM ADJUSTMENT
AM*	Antimicrobial coating applied to tactile surfaces	\$162.00
VD1	6EWS Trim and 6200R/V/CV exit device adapted to fit existing Von Duprin 98/99 door prep.	N/C
VD2	6EWS Trim adapted to fit existing Von Duprin 98/99 Device.	\$50.00
PRI	6EWS Trim adapted to fit existing Precision 2100 Device.	\$50.00
YC1	6EWS Trim adapted to fit existing Yale 7000 or Corbin Russwin ED5000 Device.	\$50.00
DK1	6EWS Trim adapted to fit existing Dorma 9300 Device.	\$50.00

*Parts discount applies

Configurations

CYLINDERS	PAGE 57
CORES	PAGE 57
KEYWAYS	PAGE 57
HIGH SECURITY CYLINDERS	PAGE 62
KEYING SYSTEMS	PAGE 63

EFFECTIVE JULY 15, 2019

Cloud Hosted Access Management Solution

MOBILE-BASED/BLUETOOTH ACCESS CONTROL

Typical Applications

- Churches
- Federal and state government
- Healthcare
- Hospitality
- Industrial
- K-12, higher education
- Offices
- Public buildings



Credentials



PHONE



SMART WATCH



KEY

Works With



Features

- Mobile phone, smart watch and keyed access options
- Aesthetically pleasing design to match today's smart building environments
- 24/7 access and ability to create schedules
- Powered by 4 AA alkaline batteries
- Built from KM Heavy Duty Deadbolts
- Works with Alexa, Google Home, Nest cameras and other "Smart" devices
- Available in conventional and SFIC cylinder format
- Keyways of other manufacturers are available
- Retrofits are easy, utilizes standard deadbolt prep.

Architectural Finishes



606 (US4)
Satin Brass



613 (US10B)
Oil Rubbed Bronze



619 (US15)
Satin Nickel



626 (US26D)
Satin Chromium



EXTERIOR VIEW



INTERIOR VIEW

COMING SOON

Cylinders



KMS-STs HEAVY DUTY DEADBOLT

LIST PRICE

Effective July 15, 2019

Function

FUNCTION	FUNCTION NUMBER	OUTSIDE INSIDE	DESCRIPTION
Single Cylinder	116		<ul style="list-style-type: none"> Lock or unlock by key from outside, by thumb turn from inside

How to Order

QTY	SERIES	FAMILY	FUNCTION	FINISH	HANDING	BACKSET	CYLINDER	KEYWAY	KEYING
	KMS	STS	116	626 605* 613 622	RH LH	ADJ 234 - 2-3/4" 238 - 2-3/8" ADJ - Adjustable 2-3/4"-2-3/8" ADJR - Adjustable 2-3/4"-2-3/8" Radius	D D - Default	SCC KW	KD KD - Keyed Different KO - Zero Bitted KA - Keyed Alike KE - Keyed to Existing MK - Master Key CMK - Construction Master Key
							PAGE 61		
							PAGE 60		



Configurations

BACKSET	PAGE 60
CYLINDERS	PAGE 61
CORES	PAGE 61
KEYWAYS	PAGE 61
HIGH SECURITY CYLINDERS	PAGE 62
KEYING SYSTEMS	PAGE 63

List Price

	FUNCTION	DESCRIPTION	626	605* 613/622
Single Cylinder	116	Entrance		

*Contact Factory for Lead-time

COMING SOON

Smart Switch



ZBOX

How to Order

QTY	DESCRIPTION	PART NUMBER	LIST
	Smart Switch, 1 set of contacts	ZBOX	\$580.00

Tablet



Android Operating System based 7" tablet. Data plan not included, can be used over Wi-Fi for device and system management.

How to Order

QTY	DESCRIPTION	PART NUMBER	LIST
	Android Tablet for Deployments and End User	ZTAB1	\$550.00

Hybrid Cloud Network Device



HCND

How to Order

QTY	DESCRIPTION	PART NUMBER	LIST
	Hybrid Cloud Network Device with Ethernet Bridge PoE, BLE, Aluminium Housing	HCND	\$1,185.00

Range Extender

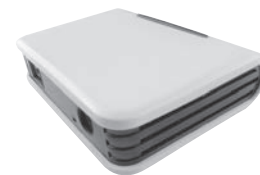

RANGE EXTENDER

How to Order

QTY	DESCRIPTION	PART NUMBER	LIST
	Range Extender	ZECHO	\$520.00



XLS Networked Access Control



PHONE



13.56 MHz



SMART WATCH



PIN



KEY



Works with
Google Home



EFFECTIVE JULY 15, 2019

Cloud Hosted Access Management Solution

NETWORKED ACCESS CONTROL

Typical Applications

- Assisted Living
- Healthcare
- Houses of Worship
- Industrial
- Manufacturing
- Multi-family
- Offices
- Schools

Multi-Credential Solutions



Works With



Features

- Built from PDQ's World-Class MR Series Grade 1 Mortise Lock.
- No hard wiring required. Powered by Four AA batteries
- Multi-credential solutions, BLE, Mifare 13.56 MHz RFID, PIN Code & Key.
- Designed for quick installation. Fits standard ANSI/BHMA A156.115 Door Prep for Mortise Locks.
- Built in Bluetooth connects to your Bluetooth BLE enabled smart phone or tablet.
- NSA level security. Equipped with multi-layer door to cloud data security utilizing AES-128 bit encryption for over-the-air transmissions.
- Key override function: MRS 116-XLS Entrance (default). Deadbolt available MRS136-XLS.
- Locking function can be changed to Passage by an authorized credential holder.
- Levers are non-handed.
- For doors: 1-3/4" to 2-1/4" thick.
- Key Systems: Compatible with BEST[®], Schlage[®] and most other major manufacturers.

Cylinders



Rose Designs



ROUND ROSE (SF) F-TRIM SQUARE ROSE (SR) J-TRIM



ROUND ROSE (SJ) J-TRIM

Lever Designs

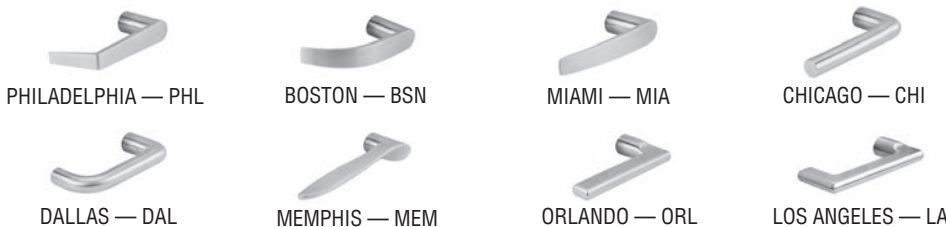

MADE IN THE USA

Architectural Finishes

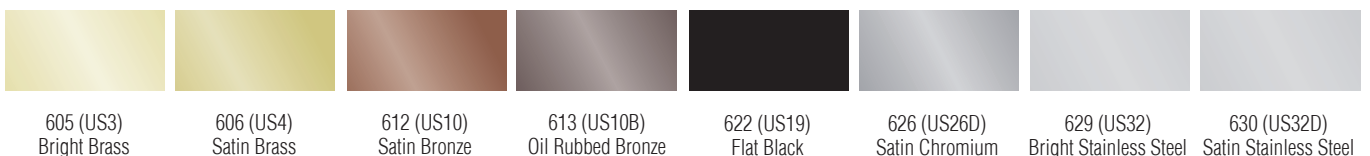

MRS-XLS MORTISE LOCKS

LIST PRICE

Effective July 15, 2019

Function

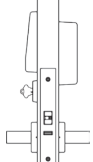
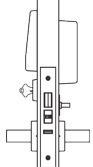
FUNCTION	FUNCTION NUMBER	OUTSIDE INSIDE	DESCRIPTION
Entrance	116		<ul style="list-style-type: none"> • Outside lever always locked (factory default). • Key outside retracts latchbolt. • Outside lever is momentarily unlocked by a valid credential. • Outside lever is relocked after predetermined time as managed by the system administrator. • Outside lever can be changed to passage by the system administrator. • Inside lever always retracts the latchbolt and allows unimpeded egress.
Dormitory/Exit	136		<ul style="list-style-type: none"> • Latchbolt operated by lever from either side • Key outside extends/retracts deadbolt • Thumbturn inside extends/retracts deadbolt • Inside lever simultaneously retracts latchbolt and deadbolt • Outside lever is momentarily unlocked by a valid credential • Outside lever is relocked after predetermined time as managed by the system administrator • Outside lever can be changed to passage by the system administrator

How to Order

QTY	SERIES	FAMILY	FUNCTION	LEVER	TRIM	FINISH	HANDING	BACKSET	STRIKE	CYLINDER	KEYWAY	KEYING	OPTIONS
	MRS	XLS	116	PJ	SJ	626	RH	234	ASA	D	SCC	KD	-
			136	J-TRIM PJ - PHL BJ - BSN MJ - MIA CJ - CHI DJ - DAL LJ - LA OJ - ORL TJ - MEM KJ - K F-TRIM PF - PHL BF - BSN MF - MIA	J-TRIM SJ - Sectional Round Rose SR - Sectional Square Rose SF - Sectional Round Rose	605 606 612 613 622 629 630	RHR LH LHR			D - Default L - Less Cylinder SF6 - SFIC w/Core, 6 Pin SF7 - SFIC w/Core, 7 Pin LF - Schlage® Compatible LFIC w/Core SFL - SFIC Housing less core LFL - Schlage® Compatible LFIC Housing less core	AR1 C059A1 C06 CL4 RUD SCE SCC SCC-K SAL RA-RC YA8 GA FAL KW TA A	KD - Keyed Different KO - Zero Bitted KA - Keyed Alike KE - Keyed to Existing MK - Master Key CMK - Construction Master Key	TC1IS - Tactile Abrasive Coating - Inside only TC10S - Tactile Abrasive Coating - Outside only TC2 - Tactile Abrasive Coating - Both Sides SF - Split Finishes LL - Lead-Lined Rose DB - Dust Box AM - Antimicrobial Coating SSH - Security Head Screws ADA - Disability Thumbturn



PAGE 54

PAGE 33

List Price

	FUNCTION	DESCRIPTION	626*/630	605/606/612 613/622/629
Single Cylinder	116	Entrance	\$940.00	\$1020.00
Double Cylinder w/Deadbolt	136	Dormitory/Exit	\$1020.00	\$1100.00

*626 available in F Trim only

Options

CODE	DESCRIPTION	LOCK ADJUSTMENT
TC1IS	Tactile Abrasive Coating - Inside only (PHL and MIA levers only)	\$43.00
TC1OS	Tactile Abrasive Coating - Outside only (PHL and MIA levers only)	
TC2	Tactile Abrasive Strip - Both Sides (PHL and MIA levers only)	\$306.00
LL	Lead-wrapped Case	\$86.00
SHS	Security Head Screws	\$26.00
SF	Split Finishes	Higher of 2 Finishes
AM*	Antimicrobial Coating - Sectional Mortise Lock inside lever, rose, thumbturn, outside lever	\$60.00
ADA	Disability Turn (ADA) - for J Trim Only	\$18.00
DB	Dust Box	\$4.00

*Parts discount applies



ADA Thumbturn

Configurations

CYLINDERS	PAGE 54
CORES	PAGE 54
KEYWAYS	PAGE 54
HIGH SECURITY CYLINDERS	PAGE 62
KEYING SYSTEMS	PAGE 63

EFFECTIVE JULY 15, 2019

Cloud Hosted Access Management Solution

NETWORKED ACCESS CONTROL

Typical Applications

- Commercial Buildings
- Healthcare
- Houses of Worship
- Industrial
- Institutional
- Manufacturing
- Multi-family
- Offices
- Schools

Multi-Credential Solutions



Works With



EXTERIOR VIEW



INTERIOR VIEW

Features

- Built from PDQ's World-Class GT Series Grade 1 Cylindrical Lock.
- No hard wiring required. Powered by Four AA batteries
- Multi-credential solutions, BLE, Mifare 13.56 MHz RFID, PIN Code & Key.
- NSA level security. Equipped with multi-layer door to cloud security utilizing AES-128 encryption for over-the-air transmissions.
- Easily upgrade existing mechanical openings to pdqSMART Access Control with 4 ea. AA batteries.
- Requires minimal field preparation to retrofit existing devices (161 prep).
- Key override function: GTS116-XLS Entrance (default).
- Can be set to passage by authorized system administrator.
- All levers field handed, fits doors 1 3/4" to 2" thick.
- Available in most major key systems including BEST SFIC and Schlage LFIC.

Lever Designs



Cylinders



Architectural Finishes



- 606 (US4) Satin Brass
- 612 (US10) Satin Bronze
- 613 (US10B) Oil Rubbed Bronze
- 619 (US15) Satin Nickel
- 622 (US19) Flat Black
- 626 (US26D) Satin Chromium

MADE IN THE USA

GTS-XLS CYLINDRICAL LOCK

LIST PRICE

Effective July 15, 2019

pdqSMART-XLS
CLOUD HOSTED ACCESS MANAGEMENT SOLUTION

Function

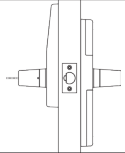
FUNCTION	FUNCTION NUMBER	OUTSIDE INSIDE	DESCRIPTION
Entrance	116		<ul style="list-style-type: none"> • Outside lever always locked (factory default). • Outside lever is momentarily unlocked by a valid credential or by key. • Outside lever is relocked after predetermined time as managed by the authorized credential holder. • Outside lever can be changed to passage by authorized credential holder. • Inside lever always retracts the latchbolt and allows unimpeded egress.

How to Order

QTY	SERIES	FAMILY	FUNCTION	TRIM	FINISH	HANDING	BACKSET	STRIKE	CYLINDER	KEYWAY	KEYING	OPTIONS
	GTS	XLS	116	PHL	626	RH	234	ASA	D	SCC	KD	—
				BOS	606	LH	234 - 2-3/4" (default)	ASA - ANSI/ASA (default)	D - Default	AR1	KD - Keyed Different	TC1IS - Tactile Abrasive Coating - Inside only
				MIA	612		5 - 5"	FL - Full Lip	L - Less Cylinder	CO59A1	KO - Zero Bitted	TC10S - Tactile Abrasive Coating - Outside only
					613		PAGE 55	T - "T" Strike	SF6 - SFIC w/Core, 6 Pin	CL4	KA - Keyed Alike	TC2 - Tactile Abrasive Coating - Both Sides
					619				SF7 - SFIC w/Core, 7 Pin	RUD	KE - Keyed to Existing	SF - Split Finishes
					622				LF - Schlage® Compatible LFIC w/Core	SCE	MK - Master Key	LL - Lead-Lined Rose
									SFL - SFIC Housing less core	SCC	CMK - Construction Master Key	DB - Dust Box
									LFL - Schlage® Compatible LFIC Housing less core	SCC-K		AM - Antimicrobial Coating
									PAGE 55	SAL		PAGE 36
										RA-RC		
										YA8		
										GA		
										FAL		
										KW		
										TA		
										A		
										PDQ1		
										PDQ2		
										PDQ3		
										PAGE 55		



List Price

	FUNCTION	DESCRIPTION	626	606/612/613 619/622
Single Cylinder	116	Entrance	\$830.00	\$910.00

GTS-XLS CYLINDRICAL LOCK

LIST PRICE

Effective July 15, 2019

Options

CODE	DESCRIPTION	LOCK ADJUSTMENT
TC1IS	Tactile Abrasive Coating - Inside only (PHL and MIA levers only)	\$43.00
TC1OS	Tactile Abrasive Coating - Outside only	
TC2	Tactile Abrasive Coating - Both Sides	\$86.00
LL	Lead-Lined Rose	\$346.00
DB	Dust Box	\$4.00
SF	Split Finishes	Higher of 2 Finishes
AM*	Antimicrobial Coating, Lever Set Includes Inside and Outside Lever and Rose	\$62.00

*Parts discount applies

Configurations

BACKSET	PAGE 55
STRIKES	PAGE 55
CYLINDERS	PAGE 55
KEYWAYS	PAGE 55
CORES	PAGE 56
HIGH SECURITY CYLINDERS	PAGE 62
KEYING SYSTEMS	PAGE 63

EFFECTIVE JULY 15, 2019

Cloud Hosted Access Management Solution

NETWORKED ACCESS CONTROL

Typical Applications

- Assisted Living
- Healthcare
- Houses of Worship
- Industrial
- Manufacturing
- Multi-family
- Offices
- Schools
- Warehousing

Multi-Credential Solutions



PHONE 13.56 MHz SMART WATCH PIN KEY

Features

- Built from PDQ's World-Class 6 EW Series Heavy Duty Exit Device Trim.
- For use with PDQ's 6200 Series RIM, Surface Vertical Rod and Concealed Vertical Rod Exit Devices.
- No hard wiring required. Powered by Four AA batteries
- Multi-credential solutions, BLE, Mifare 13.56 MHz RFID, PIN Code & Key.
- NSA level security. Equipped with multi-layer door to cloud data security utilizing AES-128 encryption for over-the-air transmissions.
- Designed for quick installation. Fits standard 6 EW door prep. One additional hole required.
- Retrofits Von Duprin 98/99 exit devices. Through bolt holes line-up for easy installation.
- Retrofits Yale 7000 and Corbin Russwin ED5000 exit devices.
- Key override function: ANSI/BHMA 09 Storeroom (default).
- Locking function can be changed to Passage by an authorized credential holder.
- All levers field handed.
- For doors: 1-3/4" to 2" thick.
- Key Systems: Compatible with BEST[®], Schlage[®] and most other major manufacturers.



Cylinders



Lever Designs



PHL — PHILADELPHIA BSN — BOSTON MIA — MIAMI ORL - ORLANDO

Architectural Finishes



606 (US4) Satin Brass 613 (US10B) Oil Rubbed Bronze 622 (US19) Flat Black 626 (US26D) Satin Chromium

MADE IN THE USA 

6EWS-XLS EXIT DEVICE TRIM

LIST PRICE

Effective July 15, 2019

How to Order

QTY	SERIES	FAMILY	LEVER	TRIM	FINISH	HANDING	CYLINDER	KEYWAY	KEYING	OPTIONS
	6EWS	XLS	PHL	—	626	LHR	D	SCC	KD	—
			BOS		606	RHR	D - Default L - Less Cylinder SF6 - SFIC w/ Core, 6 Pin SF7 - SFIC w/ Core, 7 Pin LF - Schlage® Compatible LFIC w/Core SFL - SFIC Housing less core LFL - Schlage® Compatible LFIC Housing less core	AR1 C059A1 C06 CL4 RUD SCE SCC SCC-K SAL RA-RC YA8 GA FAL KW TA	KD - Keyed Different KO - Zero Bitted KA - Keyed Alike KE - Keyed to Existing MK - Master Key CMK - Construction Master Key	AM - Antimicrobial Coating VD1 - Adapts 6EWS Trim and 6200R/V/CV exit device to fit existing Von Duprin 98/99 door prep. VD2 - Adapts 6EWS Trim to fit existing Von Duprin 98/99 exit device. PRI - Adapts 6EWS Trim to fit existing Precision 2100 Device. YC1 - Adapts 6EWS Trim to fit existing Yale 7000 or Corbin Russwin ED5000 Device. DK1 - Adapts 6EWS Trim to fit existing Dorma 9300 Device.
			MIA		613					
			ORL		622					



List Price

DESCRIPTION	626	606/613/622
6EWS-XLS	\$1085.00	\$1115.00

Options

CODE	DESCRIPTION	TRIM ADJUSTMENT
AM*	Antimicrobial coating applied to tactile surfaces	\$162.00
VD1	6EWS Trim and 6200R/V/CV exit device adapted to fit existing Von Duprin 98/99 door prep.	N/C
VD2	6EWS Trim adapted to fit existing Von Duprin 98/99 Device.	\$50.00
PRI	6EWS Trim adapted to fit existing Precision 2100 Device.	\$50.00
YC1	6EWS Trim adapted to fit existing Yale 7000 or Corbin Russwin ED5000 Device.	\$50.00
DK1	6EWS Trim adapted to fit existing Dorma 9300 Device.	\$50.00

*Parts discount applies

Configurations

CYLINDERS	PAGE 57
CORES	PAGE 57
KEYWAYS	PAGE 57
HIGH SECURITY CYLINDERS	PAGE 62
KEYING SYSTEMS	PAGE 63

EFFECTIVE JULY 15, 2019

Cloud Hosted Access Management Solution

NETWORKED ACCESS CONTROL

Typical Applications

- Assisted Living
- Houses of Worship
- Industrial
- Manufacturing
- Medium/Light Commercial Installations
- Multi-family
- Offices
- Student Housing

Multi-Credential Solutions



Works With



EXTERIOR VIEW



INTERIOR VIEW

Features

- Built from PDQ's World-Class SD Series Grade 2 Cylindrical Lock.
- No hard wiring required. Powered by Four AA batteries
- Multi-credential solutions, BLE, Mifare 13.56 MHz RFID, PIN Code & Key.
- NSA level security. Equipped with multi-layer door to cloud security utilizing AES-128 encryption for over-the-air transmissions.
- Easily upgrade existing mechanical openings to pdqSMART Access Control with 4 ea. AA batteries.
- Requires minimal field preparation to retrofit existing devices (161 prep).
- Key override function: SDS116-XLS Entrance (default).
- Can be set to passage by authorized system administrator.
- All levers field handed, fits doors 1 3/8" to 1 3/4" thick.
- Available in most major key systems including BEST SFIC.

Lever Designs



Cylinders



Architectural Finishes



SDS-XLS CYLINDRICAL LOCK

LIST PRICE
Effective July 15, 2019

Function

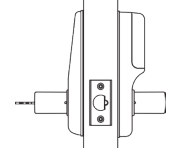
FUNCTION	FUNCTION NUMBER	OUTSIDE INSIDE	DESCRIPTION
Entrance	116		<ul style="list-style-type: none"> • Outside lever always locked (factory default). • Outside lever is momentarily unlocked by a valid credential or by key. • Outside lever is relocked after predetermined time as managed by the authorized credential holder. • Outside lever can be changed to passage by authorized credential holder. • Inside lever always retracts the latchbolt and allows unimpeded egress.

How to Order

QTY	SERIES	FAMILY	FUNCTION	TRIM	FINISH	HANDING	BACKSET	STRIKE	CYLINDER	KEYWAY	KEYING	OPTIONS
	SDS	XLS	116	PHL	626	RH	234	ASA	D	SCC	KD	—
				BOS	605	LH	234 - 2-3/4"	ASA - ANSI/ASA (default)	D - Default	AR1	KD - Keyed Different	TC1IS - Tactile Abrasive Coating - Inside only
				MIA	613		234F - 2-3/4" Fire Rated Latch	FL - Full Lip	L - Less Cylinder	CO59A1	KO - Zero Bitted	TC10S - Tactile Abrasive Coating - Both Sides
				ORL			234FR - 2-3/4" Fire Rated Latch, Radius	T - "T" Strike	SF6 - SFIC w/Core, 6 Pin	CL4	KA - Keyed Alike	TC2 - Tactile Abrasive Coating - Both Sides
				MEM			238 - 2-3/8"		SF7 - SFIC w/Core, 7 Pin	RUD	KE - Keyed to Existing	SF - Split Finishes
							238F - 2-3/8" Fire Rated Latch			SCE	MK - Master Key	LL - Lead-Lined Rose
							238FR - 2-3/8" Fire Rated Latch, Radius			SCC	CMK - Construction Master Key	DB - Dust Box
										SCC-K		
										SAL		
										RA-RC		
										YA8		
										GA		
										FAL		
										KW		
										TA		
										A (BEST Keyways)		
										PDQ1		
										PDQ2		
										PDQ3		
										PAGE 59		



List Price

	FUNCTION	DESCRIPTION	626	605/613
Single Cylinder	116	Entrance	\$665.00	\$695.00

Options

CODE	DESCRIPTION	LOCK ADJUSTMENT
TC1IS	Tactile Abrasive Coating - Inside only	\$43.00
TC1OS	Tactile Abrasive Coating - Outside only	
TC2	Tactile Abrasive Coating - Both Sides	\$86.00
SF	Split Finishes	Higher of 2 Finishes
DB	Dust Box	\$4.00
LL	Lead Lined Rose	\$146.00

Parts discount applies

Configurations

BACKSET	PAGE 58
STRIKES	PAGE 58
CYLINDERS	PAGE 59
CORES	PAGE 59
KEYWAYS	PAGE 59
HIGH SECURITY CYLINDERS	PAGE 62
KEYING SYSTEMS	PAGE 63

EFFECTIVE JULY 15, 2019

Cloud Hosted Access Management Solution

NETWORKED ACCESS CONTROL

Typical Applications

- Assisted Living
- Commercial Buildings
- Institutional
- Military Housing
- Multi-family
- Offices
- Student Housing

Multi-Credential Solutions



Features

- Built from PDQ's KM Series Heavy Duty Bored Deadbolts.
- No hard wiring required. Powered by Four AA batteries
- Multi-credential solutions, BLE, Mifare 13.56 MHz RFID, PIN Code & Key.
- NSA level security. Equipped with multi-layer door to cloud security utilizing AES-128 encryption for over-the-air transmissions.
- Easily upgrade existing mechanical openings to pdqSMART Access Control with 4 ea. AA batteries.
- Requires minimal field preparation to retrofit existing devices (161 prep).
- Available in SCC, KW1 and SFIC keyways.

Works With



Architectural Finishes

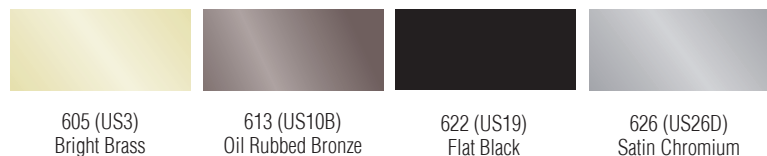

EXTERIOR VIEW



INTERIOR VIEW

Cylinders



KMS-XLS HEAVY DUTY DEADBOLT

LIST PRICE

Effective July 15, 2019

pdqSMART-XLS
CLOUD HOSTED ACCESS MANAGEMENT SOLUTION

Function

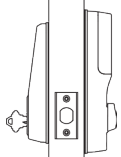
FUNCTION	FUNCTION NUMBER	OUTSIDE INSIDE	DESCRIPTION
Single Cylinder	116		<ul style="list-style-type: none"> Lock or unlock by key from outside, by thumb turn from inside

How to Order

QTY	SERIES	FAMILY	FUNCTION	FINISH	HANDING	BACKSET	CYLINDER	KEYWAY	KEYING
	KMS	XLS	116	626 605* 613 622	RH LH	ADJ ADJ - Adjustable 2-3/4"-2-3/8" ADJR - Adjustable 2-3/4"-2-3/8" Radius PAGE 60	D D - Default PAGE 61	SCC KW	KD KD - Keyed Different KO - Zero Bitted KA - Keyed Alike KE - Keyed to Existing MK - Master Key CMK - Construction Master Key



Configurations

BACKSET	PAGE 60
CYLINDERS	PAGE 61
CORES	PAGE 61
KEYWAYS	PAGE 61
HIGH SECURITY CYLINDERS	PAGE 62
KEYING SYSTEMS	PAGE 63

List Price

	FUNCTION	DESCRIPTION	626	605* 613/622
Single Cylinder	116	Entrance	\$430.00	\$450.00

*Contact factory for lead time



XLS Accessories

LIST PRICE

Effective July 15, 2019

Hybrid Cloud Network Device



HCND

Range Extender

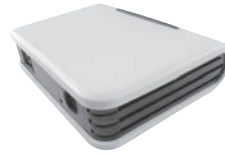

ZECHO



ZECHO 2

How to Order

QTY	DESCRIPTION	PART NUMBER	LIST
	Hybrid Cloud Network Device with Ethernet Bridge PoE, BLE, Aluminium Housing	HCND	\$1,185.00

How to Order

QTY	DESCRIPTION	PART NUMBER	LIST
	Range Extender	ZECHO	\$520.00
	Range Extender, PoE	ZECHO2	\$780.00

Smart Switch



ZBOX

ZBOX 2

Reader/Controller



SRAC

SRAC-NP

How to Order

QTY	DESCRIPTION	PART NUMBER	LIST
	Smart Switch, 1 set of contacts	ZBOX	\$580.00
	Smart Switch, 2 set of contacts	ZBOX2	\$780.00

How to Order

QTY	DESCRIPTION	PART NUMBER	LIST
	Reader/Controller, Narrow Stile with PIN Pad	SRAC	\$520.00
	Reader/Controller, Narrow Stile without PIN Pad	SRAC-NP	\$780.00

Credential Enroller



9050

Provisioning tool, Mifare NFC-P, Mifare RFID
Desktop reader/writer USB black.

Tablet



Android Operating System based 7" tablet.
Data plan not included, can be used over Wi-Fi
for device and system management.
BLE Credential

How to Order

QTY	DESCRIPTION	PART NUMBER	LIST
	Credential Enroller	9050	\$422.00

How to Order

QTY	DESCRIPTION	PART NUMBER	LIST
	Android Tablet for Deployments and End User	ZTAB1	\$550.00

XLS Credentials

LIST PRICE

Effective July 15, 2019



9010B / 9010C

Mifare Classic PVC Card (Blank)
- Suitable for customization



9010

Mifare Classic PVC Card with
pdqSMART Logo



9020

Mifare Classic Fob - Convenient
for key-chain attachment



9030

Mifare Classic Wearables -
Supports active lifestyles and
on-the-go security

Credential Information

PART NUMBER	TECHNOLOGY	FORMAT	PRINTED FINISH	COLORS/GRAPHIC
9010	Mifare classic 1k	Card	pdqSMART Logo	pdqSMART Logo
9010C	Mifare classic 1k	Card	Custom Print*	Custom Print*
9010B	Mifare classic 1k	Card	Blank	White
9020	Mifare classic 1k	Fob	—	Blue/Red/Black
9030	Mifare classic 1k	Wrist band	—	Blue/Red/Black
9040	Mifare classic 1k	Tag	—	White
9701	Mifare classic 1k + HID	Card	pdqSMART Logo	pdqSMART Logo
9701C	Mifare classic 1k + HID	Card	Custom Print*	Custom Print*
9701B	Mifare classic 1k + HID	Card	Blank	White

How to Order

QTY	DESCRIPTION	PART NUMBER	LIST
	Mifare Classic 1k Card w/ pdqSMART Logo	9010	\$7.80
	Mifare Classic 1k Card, Blank	9010C	Contact Factory
	Mifare Classic 1k Card, Custom Printed	9010B	
	Mifare Classic 1k Fob	9020	\$8.90
	Mifare Classic 1k Wrist Band	9030	Contact Factory
	Mifare Classic 1k Adhesive Tag	9040	
	Mifare Classic 1k + HID Card w/ pdqSMART Logo	9701	
	Mifare Classic 1k + HID Card, Blank	9701C	
	Mifare Classic 1k + HID Card, Custom Printed	9701B	

*Custom printed cards — contact customer service for details, pricing and minimum order.

pdqSMART-XLS Subscription and Maintenance Cost

LIST PRICE
Effective July 15, 2019

Multi-Tenant

Yearly Annual Subscription and Maintenance Cost Calculations Multi-Tenant

Calculations are per networked device, this includes, Locks, ZBOX's, SRAC's, HCND's, ZECHO's as well as any device that resides on an account that includes network components. Sites with XLS components and/or XLS/STS components will require an annual subscription fee. Accounts can either be Single or Multi-Tenant in structure. PDQ maintains the database in the cloud and manages the cyber security aspects of the network and its communications. PDQ will provide periodic updates to all the devices and their firmware. It is the customers responsibility to execute the firmware upgrades in the field to those devices that require them.

PDQ will audit the account before and after deployment to confirm the device counts for billing purposes. All new network based pdqSMART accounts will require submission of a new account set-up form so we can create the account in the Cloud Portal. If paper work is not submitted, the account will be created in an Individual Account Portal and the additional management features will not be available. There is no annual fee requirement for sites using only pdqSMART STS or STP products.

Annual billing is handled by PDQ to the End User or Dealer depending upon agreements in place. Once payment is received by PDQ the Dealers portion (if applicable) will be sent to the Dealer. The First year software payment is due at time of purchase. Annual Billed amount is due 365 days from day of site commissioning and training. Please review your Dealer Agreement for additional details.

MULTI-TENANT		CLASS A OFFICE, MEDICAL OFFICE BUILDING, WAREHOUSE, OFFICE, RETAIL, ANY NON-HOUSING APPLICATION THAT REQUIRES PDQSMART XLS SYSTEM FUNCTIONALITY
TOTAL # OF LOCKS		MSRP COST ANNUALLY
1-5	No fee	\$-
6-10	Flat yearly fee	\$750.00

For small scale deployments of 10 locks and under we do not count the network devices. We are encouraging as much adoption of the XLS solutions as possible. This maximizes the end users return on investment and supports adoption of pdqSMART. Once a deployment reaches 11 locks we count the network devices as part of the total calculation (see below.)

MULTI-TENANT		CLASS A OFFICE, MEDICAL OFFICE BUILDING, WAREHOUSE, OFFICE, RETAIL, ANY NON-HOUSING APPLICATION THAT REQUIRES PDQSMART XLS SYSTEM FUNCTIONALITY				
TOTAL # OF DEVICES		MSRP COST PER DEVICE ANNUALLY	MONTHS	MSRP COST PER DEVICE MONTHLY	DAYS	MSRP COST PER DEVICE DAILY
11-25	w/automation	\$78.00	12	\$6.50	365	\$0.21
26-49	w/automation	\$68.00	12	\$5.67	365	\$0.19
50-99	w/automation	\$58.00	12	\$4.83	365	\$0.16
100+	w/automation	\$48.00	12	\$4.00	365	\$0.13

26 devices x \$68.00 = \$1,768.00

Subscriptions

- 2 year minimum commitment required
- Contact factory for prepaid discounted 3-5 year commitments



pdqSMART-XLS Subscription and Maintenance Cost

LIST PRICE

Effective July 15, 2019

Multi-Family

Yearly Annual Subscription and Maintenance Cost Calculations Multi-Family

Calculations are per networked device, this includes, Locks, ZBOX's, SRAC's, HCND's, ZECHO's as well as any device that resides on an account that includes network components. Sites with XLS components and/or XLS/STS components will require an annual subscription fee. Accounts can either be Single or Multi-Family in structure. PDQ maintains the database in the cloud and manages the cyber security aspects of the network and its communications. PDQ will provide periodic updates to all the devices and their firmware. It is the customers responsibility to execute the firmware upgrades in the field to those devices that require them.

PDQ will audit the account before and after deployment to confirm the device counts for billing purposes. All new network based pdqSMART accounts will require submission of a new account set-up form so we can create the account in the Cloud Portal. If paper work is not submitted, the account will be created in an Individual Account Portal and the additional management features will not be available. There is no annual fee requirement for sites using only pdqSMART STS or STP products.

Annual billing is handled by PDQ to the End User or Dealer depending upon agreements in place. Once payment is received by PDQ the Dealers portion (if applicable) will be sent to the Dealer. The First year software payment is due at time of purchase. Annual Billed amount is due 365 days from day of site commissioning and training. Please review your Dealer Agreement for additional details.

MULTI-FAMILY		APARTMENTS, CONDOS, SENIOR HOUSING, ASSISTED LIVING, STUDENT HOUSING				
TOTAL # OF DEVICES		MSRP COST PER DEVICE ANNUALLY	MONTHS	MSRP COST PER DEVICE MONTHLY	DAYS	MSRP COST PER DEVICE DAILY
1-99		\$24.00	12	\$2.00	365	\$0.07
100-249		\$22.00	12	\$1.83	365	\$0.06
250-499		\$20.00	12	\$1.67	365	\$0.05
500+		\$17.00	12	\$1.42	365	\$0.05

200 devices x \$22.00 = \$4,400.00

Subscriptions

- 2 year minimum commitment required
- Contact factory for prepaid discounted 3-5 year commitments



pdqSMART-STP Demonstration Displays

LIST PRICE
Effective July 15, 2019



**GTS-STP Cylindrical – Grade 1
(Front)**



SDS-STP Cylindrical – Grade 2



KMS-STP Heavy Duty Deadbolt



**GTS-STP Cylindrical – Grade 1
(Back)**



MRS-STP Mortise – Grade 1



6EWS-STP Heavy Duty Exit Device Trim

pdqSMART-STP Demonstration Displays

SMART SERIES	DESCRIPTION	PART #	NET PRICE
pdqSMART-STP	GTS-STP Series, Grade 1, Cylindrical	DISP GTSP	\$550.00
	KMS-STP Series Heavy Duty Deadbolt	DISP KMSP	
	6EWS-STP Series Heavy Duty Exit Device Trim	DISP 6EWS	
	MRS-STP Series Grade 1, Mortise	DISP MRSP	
	SDS-STP Series, Grade 2, Cylindrical	DISP SDSP	

pdqSMART-XLS Demonstration Displays

LIST PRICE
Effective July 15, 2019

DEMONSTRATION DISPLAYS
CLOUD HOSTED ACCESS MANAGEMENT SOLUTION



GTS-XLS Cylindrical – Grade 1 (Front)



SDS-XLS Cylindrical – Grade 2



KMS-XLS Heavy Duty Deadbolt



GTS-XLS Cylindrical – Grade 1 (Back)



MRS-XLS Mortise – Grade 1



6EWS-XLS Heavy Duty Exit Device Trim

pdqSMART-XLS Demonstration Displays

SMART SERIES	DESCRIPTION	PART #	NET PRICE
pdqSMART-XLS	GTS-XLS Series, Grade 1, Cylindrical	DISP GTSX	\$550.00
	KMS-XLS Series Heavy Duty Deadbolt	DISP KMSX	
	6EWS-XLS Series Heavy Duty Exit Device Trim	DISP 6EWSX	
	MRS-XLS Series Grade 1, Mortise	DISP MRSX	
	SDS-XLS Series, Grade 2, Cylindrical	DISP SDSX	

pdqSMART-XLS Trophy Demonstration Displays

LIST PRICE
Effective July 15, 2019



**GTS-XLS Cylindrical – Grade 1
Trophy Style
(Front)**



**SDS-XLS Cylindrical – Grade 2
Trophy Style**



**KMS-XLS Heavy Duty Deadbolt
Trophy Style**



**GTS-XLS Cylindrical – Grade 1
Trophy Style
(Back)**



**MRS-XLS Mortise – Grade 1
Trophy Style**



**6EWS-XLS Heavy Duty Exit Device Trim
Trophy Style**

pdqSMART-XLS Demonstration Displays - Trophy Style

SMART SERIES	DESCRIPTION	PART #	NET PRICE
pdqSMART-XLS	GTS-XLS Series, Grade 1, Cylindrical - Trophy Style	DISP T GTSX	\$450.00
	KMS-XLS Series Heavy Duty Deadbolt - Trophy Style	DISP T KMSX	
	SDS-XLS Series, Grade 2, Cylindrical - Trophy Style	DISP T SDSX	
	MRS-XLS Series Grade 1, Mortise - Trophy Style	DISP T MRSX	
	6EWS-XLS Series Heavy Duty Exit Device Trim - Trophy Style	DISP T 6EWSX	



Key Systems

Cylinders and Keys

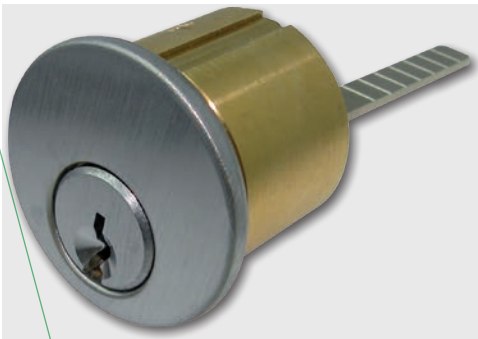
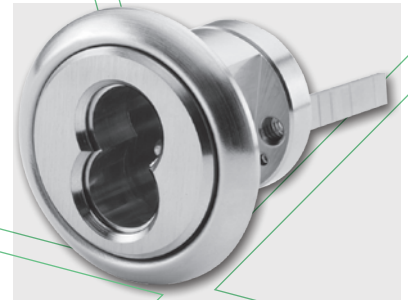
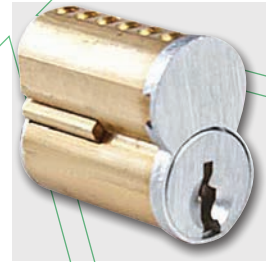
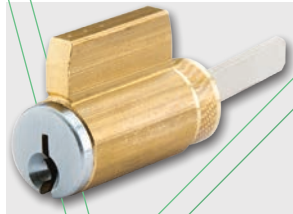

MRS-STP/STS/XLS MORTISE LOCKS

LIST PRICE
Effective July 15, 2019

Cylinders

PDQ KEYWAY	COMPATIBLE WITH	SOLD WITH LOCK
AR1	Arrow / AR1	N/C
CO59A1	Corbin / 59A1	
CO6	Corbin / 60	
CL4	Corbin / L4	
RUD	Russwin / D1	
SCE	Schlage / E	
SCC	Schlage / C	
SCC-K	Schlage / C-K	
SAL	Sargent / LA	
RA-RC	Sargent / RA-RC	
YA8	Yale / E1R	
GA	Yale / GA	
FAL	Falcon / E-R	
KW	Kwikset	
TA	PDQ / TA (Restricted. Limited to Grandmaster systems w/4 masters)	
Dummy	—	
T-Turn	—	
NON	Less Cylinder	Deduct \$4.00
HIGH SECURITY CYLINDERS AND CORES		
SEE HIGH SECURITY CYLINDERS AND CORES SECTION, PAGE 62.		



MRS-STP



Mortise Cylinder



MRS-STS

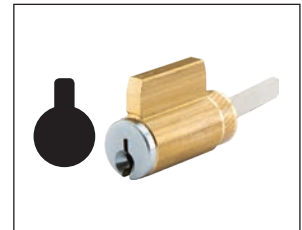

UL 437 and High Security Cylinders



MRS-XLS

NOTES:

- Uncombined cores do not include springs & pins
- Combined cores include master keying in the list price
- **PDQ1, PDQ2, PDQ3 (Restricted)**
BEST A2 & A4 Systems Available
- Control Keys must be ordered separately

Cores

DESCRIPTION	PDQ NO.	SOLD WITH LOCK	SOLD WITHOUT LOCK
SMALL FORMAT UNCOMBINED			
6 Pin Cores	I5206 + KEYWAY	\$47.00	\$61.00
7 Pin Cores	I5207 + KEYWAY	\$47.00	\$61.00
COMBINED			
6 Pin Cores	I5206-1 + KEYWAY	\$47.00	\$78.00
7 Pin Cores	I5207-1 + KEYWAY	\$47.00	\$78.00
BEST® Compatible			
A (DEFAULT), B, C, D, E, F, G, H, J, K, L, M, Q, WA, WB, WC, WG, WH, TB, TD, TE, & R			
PDQ Exclusive			
PDQ1, PDQ2			
PDQ Exclusive and Restricted			
PDQ3			
SFIC CONSTRUCTION			
Construction Core 6-pin only		\$47.00	\$61.00
Dummy Construction Core Plastic		\$5.00	\$5.00
LFIC CONSTRUCTION			
Construction Core 6-pin only		\$55.00	\$80.00
IC Tailpiece Assembly Construction cores are invoiced at shipment and credited upon return.		N/C	\$7.60
LFIC COMBINED			
Schlage compatible LFIC, SCC (Schlage C compatible) keyway		\$55.00	\$80.00
PDQ TA LFIC RESTRICTED			
LFIC UNCOMBINED			
Schlage compatible LFIC, SCC (Schlage C compatible) keyway		\$55.00	\$74.00
HIGH SECURITY IC CORES			
SEE HIGH SECURITY CYLINDERS AND CORES SEE PAGE 62. — LFIC REQUIRES LARGE FORMAT LEVER			

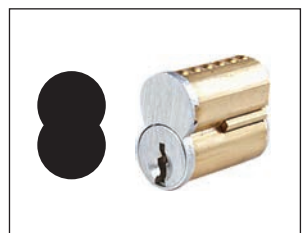

SFL/SFIC Core



LFL/LFIC Schlage Format



IC Mortise Housing

Parts discount applies

EMR* Retrofit Plate

DESCRIPTION	PDQ NO.	FINISH	PART LIST PRICE
Retrofit EMR Stand-Alone Lock with MRS-STP or MRS-XLS Lock. Plate covers EMR door prep.	88176-01	630	\$XX

Parts discount applies *EMR Product Line Discontinued replaced with MRS-STP or MRS-XLS

GTS-STP/STS/XLS CYLINDRICAL LOCKS

LIST PRICE

Effective July 15, 2019

pdqSMART
CLOUD HOSTED ACCESS MANAGEMENT SOLUTION

Backset

CODE	DESCRIPTION	LOCK ADJUSTMENT
	2-3/4" BACKSET	
234	2-3/4" Deadlocking 2-1/4" x 1-1/8"	N/C
	3-3/4" BACKSET	
334F	2-1/4" x 1-1/8"	\$32
334	2-1/4" x 1"	
	5" BACKSET	
5	2-1/4" x 1-1/8"	\$42



GTS-STP



GTS-STS



GTS-XLS



Latchbolt

Strikes

	CODE	DESCRIPTION	LOCK ADJUSTMENT
	ASA	ASA Strike (any finish) 1-1/4" x 4-7/8"	N/C
	T	T-Strike (any finish) 1-1/8" x 2-3/4"	
	FL	Full Lip Strike (any finish) 1-5/8" x 2-1/4"	

NOTES:

- Specify finish for Strikes & Latchbolts if ordered separately

NOTES:

- Specify finish for cylinders ordered separately
- Kwikset cylinder available in 5 pin only
- Specify KD, KA4, or 1 bitted
- 6 pin cylinder keyed for 5 pin

Cylinders

PDQ KEYWAY	COMPATIBLE WITH	SOLD WITH LOCK
AR1	Arrow / AR1	N/C
CO59A1	Corbin / 59A1	
CO6	Corbin / 60	
CL4	Corbin / L4	
RUD	Russwin / D1	
SCE	Schlage / E	
SCC	Schlage / C	
SCC-K	Schlage / C-K	
SAL	Sargent / LA	
RA-RC	Sargent / RA-RC	
YA8	Yale / E1R	
GA	Yale / GA	
FAL	Falcon / E-R	
KW	Kwikset	
TA	PDQ / TA (Restricted. Limited to Grandmaster systems w/4 masters)	
Dummy	—	
T-Turn	—	
NON	Less Cylinder	
HIGH SECURITY CYLINDERS AND CORES		
SEE HIGH SECURITY CYLINDERS AND CORES SECTION, PAGE 62.		

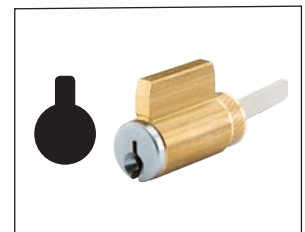

Key in Knob/Lever Cylinder



UL 437 and High Security Cylinders



GTS-STP/STS/XLS CYLINDRICAL LOCKS

LIST PRICE

Effective July 15, 2019

Cores

DESCRIPTION	PDQ NO.	SOLD WITH LOCK	SOLD WITHOUT LOCK
SMALL FORMAT UNCOMBINATED			
6 Pin Cores	I5206 + KEYWAY	\$47.00	\$61.00
7 Pin Cores	I5207 + KEYWAY	\$47.00	\$61.00
COMBINATED			
6 Pin Cores	I5206-1 + KEYWAY	\$47.00	\$78.00
7 Pin Cores	I5207-1 + KEYWAY	\$47.00	\$78.00
BEST® Compatible			
A (DEFAULT), B, C, D, E, F, G, H, J, K, L, M, Q,			
WA, WB, WC, WG, WH, TB, TD, TE, & R			
PDQ Exclusive			
PDQ1, PDQ2			
PDQ Exclusive and Restricted			
PDQ3			
SFIC CONSTRUCTION			
Construction Core 6-pin only		\$47.00	\$61.00
Dummy Construction Core Plastic		\$5.00	\$5.00
LFIC CONSTRUCTION			
Construction Core 6-pin only		\$55.00	\$80.00
IC Tailpiece Assembly Construction cores are invoiced at shipment and credited upon return.		N/C	\$7.60
LFIC COMBINATED			
Schlage compatible LFIC, SCC (Schlage C compatible) keyway		\$55.00	\$80.00
PDQ TA LFIC RESTRICTED			
LFIC UNCOMBINATED			
Schlage compatible LFIC, SCC (Schlage C compatible) keyway		\$55.00	\$74.00
HIGH SECURITY IC CORES			
SEE HIGH SECURITY CYLINDERS AND CORES SEE PAGE 62. — LFIC REQUIRES LARGE FORMAT LEVER			

NOTES:

- Specify finish for IC Cores ordered separately
- Control keys must be ordered separately
- PDQ1, PDQ2, PDQ3 (Restricted)**, Best A2 & A4 Systems Available

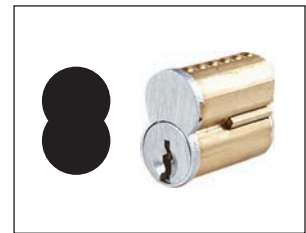

SFL/SFIC Core



LFL/LFIC Schlage Format
(PHL Lever Only)

Parts discount applies

EGT* Retrofit Plate

DESCRIPTION	PDQ NO.	FINISH	PART LIST PRICE
Retrofit EGT Stand-Alone Lock with GTS-STP or GTS-XLS Lock. Plate covers EGT door prep.	88150-01	630	\$XX

Parts discount applies *EGT Product Line Discontinued replaced with GTS-STP or GTS-XLS

6EWS-STP/STS/XLS EXIT DEVICE TRIM

LIST PRICE

Effective July 15, 2019

pdqSMART
CLOUD HOSTED ACCESS MANAGEMENT SOLUTION

Cylinders

PDQ KEYWAY	COMPATIBLE WITH	SOLD WITH LOCK
AR1	Arrow / AR1	N/C
C059A1	Corbin / 59A1	
C06	Corbin / 60	
CL4	Corbin / L4	
RUD	Ruswin / D1	
SCE	Schlage / E	
SCC	Schlage / C	
SCC-K	Schlage / C-K	
SAL	Sargent / LA	
RA-RC	Sargent / RA-RC	
YA8	Yale / E1R	
GA	Yale / GA	
FAL	Falcon / E-R	
KW	Kwikset	
TA	PDQ / TA (Restricted. Limited to Grandmaster systems w/4 masters)	
Dummy	—	
T-Turn	—	
NON	Less Cylinder	
HIGH SECURITY CYLINDERS AND CORES		
SEE HIGH SECURITY CYLINDERS AND CORES SECTION, PAGE 62.		



6EWS-STP



6EWS-STs



6EWS-XLS



Mortise Cylinder

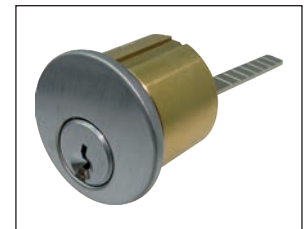

Rim Cylinder

NOTES:

- Uncombined cores do not include springs & pins
- Combined cores include master keying in the list price
- **PDQ1, PDQ2, PDQ3 (Restricted)**
BEST A2 & A4 Systems Available
- Control Keys must be ordered separately

Cores

DESCRIPTION	PDQ NO.	SOLD WITH LOCK	SOLD WITHOUT LOCK
SMALL FORMAT UNCOMBINED			
6 Pin Cores	I5206 + KEYWAY	\$47.00	\$61.00
7 Pin Cores	I5207 + KEYWAY	\$47.00	\$61.00
COMBINED			
6 Pin Cores	I5206-1 + KEYWAY	\$47.00	\$78.00
7 Pin Cores	I5207-1 + KEYWAY	\$47.00	\$78.00
BEST[®] Compatible			
A (DEFAULT), B, C, D, E, F, G, H, J, K, L, M, Q,			
WA, WB, WC, WG, WH, TB, TD, TE, & R			
PDQ Exclusive			
PDQ1, PDQ2			
PDQ Exclusive and Restricted			
PDQ3			
SFIC CONSTRUCTION			
Construction Core 6-pin only		\$47.00	\$61.00
Dummy Construction Core Plastic		\$5.00	\$5.00
LFIC CONSTRUCTION			
Construction Core 6-pin only		\$55.00	\$80.00
IC Tailpiece Assembly Construction cores are invoiced at shipment and credited upon return.		N/C	\$7.60
LFIC COMBINED			
Schlage compatible LFIC, SCC (Schlage C compatible) keyway		\$55.00	\$80.00
PDQ TA LFIC RESTRICTED			
LFIC UNCOMBINED			
Schlage compatible LFIC, SCC (Schlage C compatible) keyway		\$55.00	\$74.00
HIGH SECURITY IC CORES			
SEE HIGH SECURITY CYLINDERS AND CORES SEE PAGE 62. — LFIC REQUIRES LARGE FORMAT LEVER			

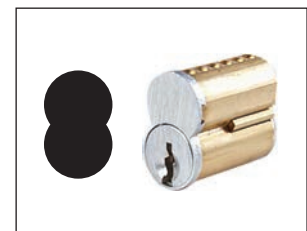

SFL/SFIC Core

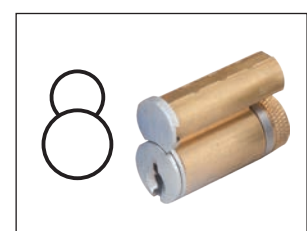

LFL/LFIC Schlage Format



IC Mortise Housing

Parts discount applies



SDS-STP/XLS CYLINDRICAL LOCKS

LIST PRICE

Effective July 15, 2019

Backset

CODE	DESCRIPTION	LOCK ADJUSTMENT
2-3/4" BACKSET		
234	2-1/4" x 1-1/8"	N/C
234F	2-1/4" x 1"	
234FR	2-1/4" x 1" x 1/4" Radius	\$7
2-3/8" BACKSET		
238F	2-1/4" x 1-1/8"	N/C
238	2-1/4" x 1"	
238R	2-1/4" x 1" x 1/4" Radius	\$7
3-3/4" BACKSET		
334F	2-1/4" x 1-1/8"	\$32
334	2-1/4" x 1"	
334R	2-1/4" x 1" x 1/4" Radius	
5" BACKSET		
5	2-1/4" x 1-1/8"	\$42
5F	2-1/4" x 1"	
5FR	2-1/4" x 1" x 1/4" Radius	



SDS-STP



Spring Latchbolt



SDS-XLS



Deadlatching Latchbolt

Strikes

	CODE	DESCRIPTION	LOCK ADJUSTMENT
	ASA	ASA Strike (any finish) 1-1/4" x 4-7/8"	N/C
	T	T-Strike (any finish) 1-1/8" x 2-3/4"	
	FL	Full Lip Strike (any finish) 1-5/8" x 2-1/4"	

NOTES:

- Specify finish for Strikes & Latchbolts if ordered separately

SDS-STP/XLS CYLINDRICAL LOCKS

LIST PRICE

Effective July 15, 2019

pdqSMART
CLOUD HOSTED ACCESS MANAGEMENT SOLUTION

Cylinders

PDQ KEYWAY	COMPATIBLE WITH	SOLD WITH LOCK	
AR1	Arrow / AR1	N/C	
CO59A1	Corbin / 59A1		
CO6	Corbin / 60		
CL4	Corbin / L4		
RUD	Russwin / D1		
SCE	Schlage / E		
SCC	Schlage / C		
SCC-K	Schlage / C-K		
SAL	Sargent / LA		
RA-RC	Sargent / RA-RC		
YA8	Yale / E1R		
GA	Yale / GA		
FAL	Falcon / E-R		
KW	Kwikset		
TA	PDQ / TA (Restricted. Limited to Grandmaster systems w/4 masters)		
Dummy	—		
T-Turn	—		
NON	Less Cylinder		Deduct \$4.00
HIGH SECURITY CYLINDERS AND CORES			
SEE HIGH SECURITY CYLINDERS AND CORES SECTION, PAGE 62			

- NOTES:**
- Specify finish for cylinders ordered separately
 - Kwikset cylinder available in 5 pin only
 - Specify KD, KA4, or 1 bitted
 - 6 pin cylinder keyed for 5 pin



Key in Knob/Lever Cylinder



UL 437 and High Security Cylinders

Cores

DESCRIPTION	PDQ NO.	SOLD WITH LOCK	SOLD WITHOUT LOCK
SMALL FORMAT UNCOMBINATED			
6 Pin Cores	I5206 + KEYWAY	\$47.00	\$61.00
7 Pin Cores	I5207 + KEYWAY	\$47.00	\$61.00
COMBINATED			
6 Pin Cores	I5206-1 + KEYWAY	\$47.00	\$78.00
7 Pin Cores	I5207-1 + KEYWAY	\$47.00	\$78.00
BEST® Compatible			
A (DEFAULT), B, C, D, E, F, G, H, J, K, L, M, Q, WA, WB, WC, WG, WH, TB, TD, TE, & R			
PDQ Exclusive			
PDQ1, PDQ2			
PDQ Exclusive and Restricted			
PDQ3			
SFIC CONSTRUCTION			
Construction Core 6-pin only		\$47.00	\$61.00
Dummy Construction Core Plastic		\$5.00	\$5.00
LFIC CONSTRUCTION			
Construction Core 6-pin only		\$55.00	\$80.00
IC Tailpiece Assembly		N/C	\$7.60
Construction cores are invoiced at shipment and credited upon return.			
HIGH SECURITY IC CORES			
SEE HIGH SECURITY CYLINDERS AND CORES SECTION, PAGE 62.			

- NOTES:**
- Specify finish for IC Cores ordered separately
 - Control keys must be ordered separately
 - PDQ1, PDQ2, PDQ3 (Restricted)**, Best A2 & A4 Systems Available



SFL/SFIC Core

Parts discount applies



KMS-STP/STS/XLS HEAVY DUTY DEADBOLT

LIST PRICE

Effective July 15, 2019



Backset

CODE	BACKSET DESCRIPTION	LOCK ADJUSTMENT
2-3/8" BACKSET		
238	2-1/4" x 1-1/8" (Standard)	N/C
238R	2-1/4" x 1-1/8" x 1/4" Radius	\$5.00
2-3/4" BACKSET		
234	2-1/4" x 1-1/8" (Standard)	N/C
234R	2-1/4" x 1-1/8" x 1/4" Radius	\$5.00
2-3/4" - 2-3/8" ADJUSTABLE		
ADJ	2-1/4" x 1-1/8" (Standard)	N/C
ADJR	2-1/4" x 1-1/8" x 1/4" Radius	\$5.00



KMS-STP



KMS-STS



KMS-STP

KMS-STP/STS/XLS HEAVY DUTY DEADBOLT

LIST PRICE

Effective July 15, 2019

pdqSMART
CLOUD HOSTED ACCESS MANAGEMENT SOLUTION

Cylinders

PDQ KEYWAY	COMPATIBLE WITH	SOLD WITH LOCK
AR1	Arrow / AR1	N/C
CO59A1	Corbin / 59A1	
CO6	Corbin / 60	
CL4	Corbin / L4	
RUD	Russwin / D1	
SCE	Schlage / E	
SCC	Schlage / C	
SCC-K	Schlage / C-K	
SAL	Sargent / LA	
RA-RC	Sargent / RA-RC	
YA8	Yale / E1R	
GA	Yale / GA	
FAL	Falcon / E-R	
KW	Kwikset	
TA	PDQ / TA (Restricted. Limited to Grandmaster systems w/4 masters)	
Dummy	—	
T-Turn	—	
NON	Less Cylinder	
HIGH SECURITY CYLINDERS AND CORES		
SEE HIGH SECURITY CYLINDERS AND CORES SECTION, PAGE 62		

- NOTES:**
- Specify finish for Mortise Cylinders ordered separately



Key in Knob/Lever Cylinder



UL 437 and High Security Cylinders

Cores and Keyways

DESCRIPTION	PDQ NO.	SOLD WITH LOCK	SOLD WITHOUT LOCK
UNCOMBINATED			
6 Pin Cores	I5206 + KEYWAY	\$47.00	\$61.00
7 Pin Cores	I5207 + KEYWAY	\$47.00	\$61.00
COMBINATED			
6 Pin Cores	I5206-1 + KEYWAY	\$47.00	\$78.00
7 Pin Cores	I5207-1 + KEYWAY	\$47.00	\$78.00
BEST® Compatible			
A (DEFAULT), B, C, D, E, F, G, H, J, K, L, M, Q,			
WA, WB, WC, WG, WH, TB, TD, TE, & R			
PDQ Exclusive			
PDQ1, PDQ2			
PDQ Exclusive and Restricted			
PDQ3			
SFIC CONSTRUCTION			
Construction Core 6-pin only		\$47.00	\$61.00
Dummy Construction Core Plastic Construction cores are invoiced at shipment and credited upon return.		\$5.00	\$5.00
HIGH SECURITY IC CORES			
SEE HIGH SECURITY CYLINDERS AND CORES SECTION, PAGE 62. — NOT AVAILABLE WITH LFIC			

- NOTES:**
- Combinated cores include master keying in the list price
 - Specify finish for IC Cores ordered separately
 - Control keys must be ordered separately
 - PDQ1, PDQ2, PDQ3 (Restricted)**, Best A2 & A4 Systems Available

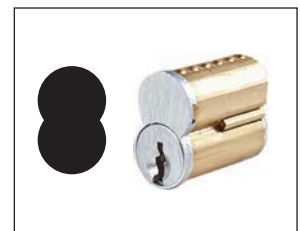

SFL/SFIC Core

Parts discount applies



HIGH SECURITY CYLINDERS, CORES, CAMS

LIST PRICE

Effective July 15, 2019

Standard High Security Cylinders

DESCRIPTION	PDQ NO.	626	605	613
6 Pin Key in Knob/Lever Cylinder KD/KA	HSC125	\$66.00	\$79.50	—
Mortise/Rim Combo Cylinder 1-1/8" 6 Pin KD/KA	HSC020	\$90.00	\$107.50	\$111.00
Mortise Cylinder 1 1/4" 6 Pin KD/KA	HSC030			
Mortise Cylinder 1 1/2" 6 Pin KD/KA	HSC050	\$120.00	—	—

Includes Keying Charges and 2 Cut Keys. NOTE: Requires master keying, see below for charge.

Parts discount applies

UL437 High Security Cylinders

DESCRIPTION	PDQ NO.	626	605	613
UL 437 6 Pin Key in Knob/Lever Cylinder KD/KA	HSC425	\$81.00	\$104.00	—
UL 437 Mortise Rim Combo Cylinder 1-1/8" KD/KA	HSC320	\$105.00	\$132.00	\$135.50
UL 437 Mortise Cylinder 1-1/4" KD/KA	HSC330			

Includes Keying Charges and 2 Cut Keys. NOTE: When ordering UL 437 Cylinders with PDQ Cylindrical or Mortise locks, the lock should be ordered Less Cylinder (LC) and a cylinder deduction applied. UL 437 and High Security Cylinders are priced at a parts discount.

NOTE: Requires master keying, see below for charge.

Parts discount applies

High Security Keying Systems

DESCRIPTION	PDQ NO.	626
Cut Key, 6 pin	HSC065	\$12.00
SFIC Cut Key, IC 7 pin	HSC874	
LFIC Control Cut Key, IC 6 pin, TA	HSC965	
Master Keying Charge		\$11.80
Key Marking Charge		\$4.80
Cylinder Marking Charge		\$4.80

Includes Keying Charges and 2 Cut Keys

Parts discount applies

High Security Cores

DESCRIPTION	PDQ NO.	626
SFIC Cylinder, 6 Pin	HSC806	\$90.00
SFIC Cylinder, 7 Pin	HSC807	\$97.50
LFIC Cylinder Schlage® compatible, 6 Pin	HSC906	\$131.25

Includes Keying Charges and 2 Cut Keys

Parts discount applies

High Security Cams

DESCRIPTION	PDQ NO.	626
Adams Rite Type Cam	HSCCAM1	\$12.00
Yale Type Cam	HSCCAM2	
Yale Narrow Type Cam	HSCCAM2A	
Ruswin Type Cam	HSCCAM3	
Falcon Type Cam	HSCCAM4	
Schlage Type Cam	HSCCAM7	
Sargent Offset Type Cam	HSCCAM8	
PDQ Cam	HSCCAM3	

Parts discount applies

NOTES:

- Prices for LF IC Mortise & Rim Cylinder Housings do not include IC Core
- Specify finish when ordering IC Housing & Cores
- High Security Cylinders not available "0" bitted.
- Key blanks for High Security Cylinders not available.

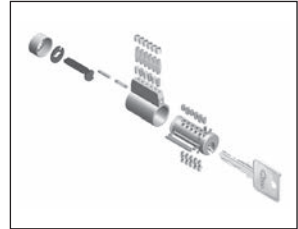

High Security Cylinder

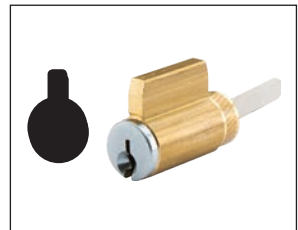

Key in Knob/Lever Cylinder

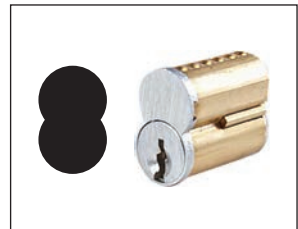

SFIC/SFIC Core

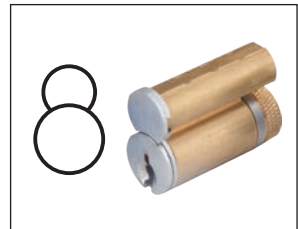

LFL/LFIC Schlage Format



UL 437 and High Security Cylinders

CODE	KEYING SYSTEMS	PART LIST PRICE
KD	Keyed Random	N/C
OB	0-Bitted with 2 blank keys (For quality control purposes, PDQ "0" bit cylinders are actually keyed to a 1 bit and a 1 bit key is sent to open cylinders.)	
KA2	Keyed Alike, 2 or less (KA2)	
KA4	Keyed Alike, 3-4 (KA3 or KA4)	\$3.00 each
KA	Keyed Alike, 5 or More (KA5)	\$8.00 each
MK	Master Keyed	\$16 each
CMK	Construction Master Keyed	\$32 each
KE	Master Keyed to Existing Bittings: • Parts Discount Applies	\$16 each
CODE	MASTER KEY SERVICES	
	Number of Bittings	
B100	1-100	\$110
B300	101-300	\$170
B1000	301-1000	\$240
B2000	1001- 2000	\$330
B5000	2001- 5000	\$420
	Master Key Service is a custom master key system that is provided with the purchase of complete PDQ manufactured locks and locking devices. A master key service charge will be assessed for any order that includes only PDQ cylinders or cores for use on non-PDQ locks or locking devices.	
BL	Bitting List for Factory Master Key Production	\$95.00
CODE	VISUAL KEY CONTROL	
VKC-KEY	Visual Key Control - Key Stamping	\$4.20
VKC-CYL	Visual Key Control - Cylinder Stamping	\$8.00
VKC-COR	Visual Key Control - Core Stamping	
CODE	MASTER/CONTROL/CHANGE KEY CUT	
MKC	Master Key	\$10.00
GMKC	Grand Master Key	
GGMKC	Grand Grand Master Key	
CMKC	Construction Master Key	
CTLK	Control Key	
CKC	Change Key	



Visual Key Control

Parts discount applies



Electrified Door Hardware

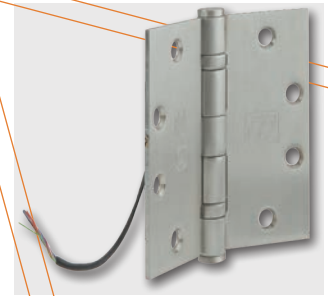
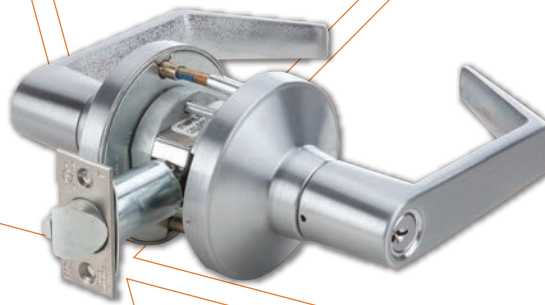
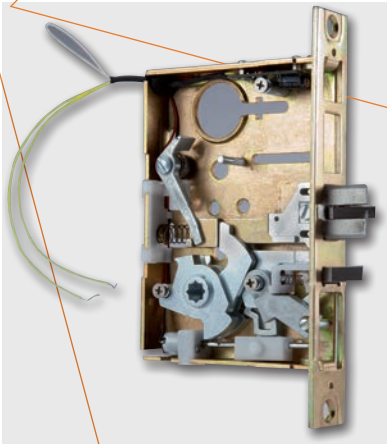

Locks

MR199A
Electrified Mortise

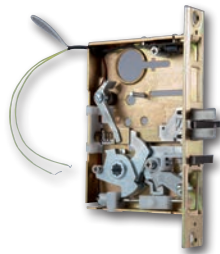

Applications

Electrified locks complement the mechanical offering and are typically incorporated into a wired access control system or used independently with a remote access switch.

XGT/GT199A
Electrified Cylindrical

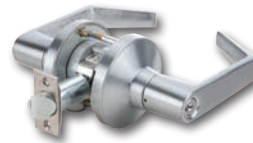

Applications

Electrified locks complement the mechanical offering and are typically incorporated into a wired access control system or used independently with a remote access switch.

Exit Device and Trim

6200/6202
Electrified Options

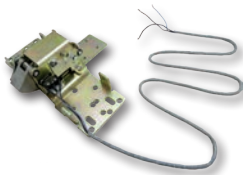

Applications

Access control exit device options including request to exit signal switch, latch bolt monitor, and battery powered alarms.

6EW199A
Electrified Trim



Applications

Electrified trim complements the mechanical offering and is typically incorporated into a wired access control system or used independently with a remote access switch.

MLR
Motorized Latch Retraction



Applications

An ideal solution for integrated exit device access control solutions requiring operational noise reduction such as Healthcare, K-12, higher education, museums, auditoriums, theaters, etc.

ELECTRIFIED HINGES



Applications

Electric hinges are used when a locking device is mounted on a moving door and power and signals must be brought off the door to the controller and house wiring. Examples of such locking devices include an electrified lockset or electrically actuated trim, electric latch retraction device or a switching device such as a REX lever or touchbar.

ELECTRIC STRIKES



Applications

Electromechanical door locking device for use with various latch bolt locksets in lieu of conventional Strikes that provide additional security, traffic control and convenience of remote operation.

KEY SWITCHES



Applications

Key switches can be activated only by the use of a key. Typical applications include situations where access needs to be restricted to the switch's functions.

PUSH BUTTONS



Applications

Commonly used on ADA openings in conjunction with an automatic operator.

POWER SUPPLIES



Applications

Power sources used to support electronic access control devices.

MR199A MR200

Grade 1 Electrified Mortise Lock



**ASSEMBLED
IN THE USA**

MR199A Electrified Storeroom MR200 Electrified Institutional

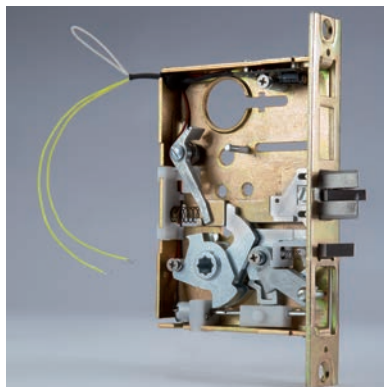

Innovative motor drive controls
FAIL SECURE or FAIL SAFE locking mode.

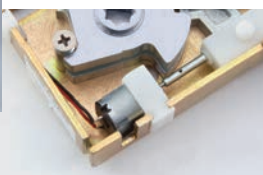

Typical Applications

- Child Care Facilities
- Computer Rooms
- Nursing Staff Lounges
- Rest Rooms
- Stairwell Towers
- Storage Areas

Features

- Motorized locking/unlocking.
- **FAIL SECURE** (Factory Default)– Outside trim is UNLOCKED when power is ON, and LOCKED when power is OFF. Lockset will lock in the event of a power failure.
- **FAIL SAFE** – Outside trim is LOCKED when power is ON, and UNLOCKED when power is OFF. Lockset will unlock in the event of a power failure.
- Field changeable from FAIL Secure to FAIL SAFE.
- Built around PDQ's World-Class MR series mortise lock chassis platform.
- Designed for AC or DC input voltage. No need to select voltage when specifying or ordering.
- Meets requirements of the Buy American Act.
- SMARTSENSE™ control board automatically accepts AC or DC input voltage.

Specifications



PERFORMANCE:	<ul style="list-style-type: none"> • Motor drive factory tested to over 1.4 million cycles (1.4 times the ANSI/BHMA grade 1 std).
RECOMMENDED POWER SUPPLY:	<ul style="list-style-type: none"> • PDQ Model # 81440. <ul style="list-style-type: none"> – Input: 120VAC, .9A, 50/60Hz 240VAC, .6A, 50/60Hz – Output: 24VDC, 2A, filtered and regulated. • Rated for simultaneous operation of 2ea mortise lock assemblies. • Power Supply Requirements: <ul style="list-style-type: none"> – AC/DC Output Voltage – 1A min (filtered and regulated). • 12-24VDC @ 1.0 A required for 5 seconds, 5mA standby after 30 sec. – AC Output Voltage. • 12-24VAC (60Hz) @ 1.0 A required for 5 seconds, 15mA standby after 30 sec
ELECTRICAL SPECIFICATIONS:	<ul style="list-style-type: none"> • Input voltage: 12-24VDC or 12-24VAC. • Max In-rush current: < 1.0A. • Standby current: <ul style="list-style-type: none"> – 12VAC: 12mA. / 24VAC: 10mA. / 12VDC: 3mA. / 24VDC: 5mA. <p>Note: Operating voltage at ± 10% of rated voltage.</p>
CERTIFICATIONS, LISTINGS, COMPLIANCES:	<ul style="list-style-type: none"> • ANSI/UL10C and CAN/ULC-5104 Listed for "Fire Exit Hardware" up to 3 hours for 4'0" x 8'0" maximum single, 8'0" x 8'0" maximum pairs. • Assembled in the U.S.A. with U.S. and foreign material. Meets requirements of the Buy American Act.
WARRANTY:	<ul style="list-style-type: none"> • 2-Years

List Price*

	ANSI NO.	FUNCTION	DESCRIPTION	626	630	605, 606, 612, 613, 629	626	630	605, 606, 612, 613, 629
MR		199A	Storeroom, Single Cylinder	\$1220.00	\$1190.00	\$1270.00	\$1280.00	\$1240.00	\$1340.00
		200	Institutional, Double Cylinder	\$1250.00	\$1220.00	\$1300.00	\$1310.00	\$1270.00	\$1370.00

*Contact Customer Service for Discount





XGT/GT199A

Electrified Cylindrical Lock Grade 1 Heavy Duty



**MADE IN
THE USA**

Typical Applications

- Computer Rooms
- High Security Areas
- Pharmacies
- Stairwell Towers
- Tenant Spaces

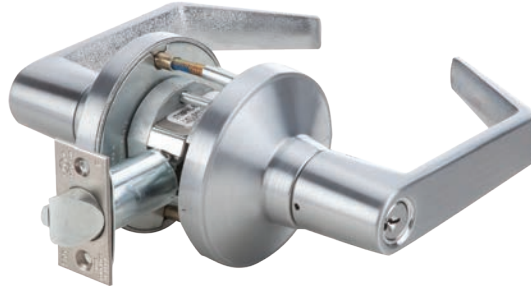

Specifications



PERFORMANCE:	<ul style="list-style-type: none"> • Motor drive factory tested to over 1.4 million cycles (1.4 times the ANSI/BHMA grade 1 std).
RECOMMENDED POWER SUPPLY:	<ul style="list-style-type: none"> • PDQ Model # 81440. <ul style="list-style-type: none"> – Input: 120VAC, .9A, 50/60Hz 240VAC, .6A, 50/60Hz – Output: 24VDC, 2A, filtered and regulated. • Rated for simultaneous operation of 2ea mortise lock assemblies. • Power Supply Requirements: <ul style="list-style-type: none"> – AC/DC Output Voltage – 1A min (filtered and regulated). • 12-24VDC @ 1.0 A required for 5 seconds, 5mA standby after 30 sec. <ul style="list-style-type: none"> – AC Output Voltage. • 12-24VAC (60Hz) @ 1.0 A required for 5 seconds, 15mA standby after 30 sec
ELECTRICAL SPECIFICATIONS:	<ul style="list-style-type: none"> • Input voltage: 12-24VDC or 12-24VAC. • Max In-rush current: < 1.0A. • Standby current: <ul style="list-style-type: none"> – 12VAC: 12mA. – 24VAC: 10mA. – 12VDC: 3mA. – 24VDC: 5mA. <p>Note: Operating voltage at ± 10% of rated voltage.</p>
CERTIFICATIONS, LISTINGS, COMPLIANCES:	<ul style="list-style-type: none"> • ANSI/UL10C and CAN/ULC-5104 Listed for “Fire Exit Hardware” up to 3 hours for 4’0” x 8’0” maximum single, 8’0” x 8’0” maximum pairs. • Assembled in the U.S.A. with U.S. and foreign material. Meets requirements of the Buy American Act.
WARRANTY:	<ul style="list-style-type: none"> • 2-Years

List Price*

	ANSI NO.	FUNCTION	DESCRIPTION	626	605/606/612 613/619/625
XGT		199A	Storeroom	\$1188.00	\$1218.00
GT		199A	Storeroom	\$1128.00	\$1158.00

*Contact Customer Service for Discount

6200 SERIES with MLR

Quiet Motorized
Latch Retraction

WHEN QUIET OPERATION IS A MUST



Typical Applications

- Child Care Facilities
- Healthcare
- Libraries
- Museums
- Theaters
- Where Ambient Noise Can Be Disruptive.



Features

- Ultra Quiet Operation
- For use with PDQ 6200 Wide Stile or 6202 Narrow Stile exit devices, panic and fire listed.
- Unique motor drive retracts Push Pad.
- Dual operation -maintained or momentary operation.
- Supports remote signaled electric dogging.
- Low power requirements. Interfaces with PDQ's 81440 2A 24VDC Filtered/Regulated Power Supply, and EL Series Electrified Power Transfer Hinges
- Suitable for pairing with Low Energy Power Operators
- Non-polarized leads
- On-board diagnostic LED lights
- UL Listed

Field Retrofit Kit

- Designed to field retrofit 6200 and 6202 series exit devices
- Includes motor drive module, connectors and fasteners
- PN 81550K-MDT

Electrical Specifications

Note: Operating voltage at $\pm 10\%$ of rated voltage.

Input voltage: 24VDC

- Rated in-rush current: 1.0A.

- Operational in-rush current: .85A.

- Continuous current, electric dogging: .4A.

- Recommended Power Supply: PDQ Model # 81440.
Input: 120VAC, .9A, 50/60Hz 240VAC, .6A, 50/60Hz
Output: 24VDC, 2A, filtered and regulated.

6200/6202 SERIES

Exit Device Alarm Switches

Electrified Options for 6200/6202 Series Exit Devices

There are a number of electrified options available for panic hardware. They are often added for a number of reasons:

- Access control
- Remote monitoring of hardware status
- Alarms to discourage use of the door
- Code compliance for stairwell doors that require re-entry
- Code compliance for fire-rated doors where electric dogging is needed



REQUEST TO EXIT

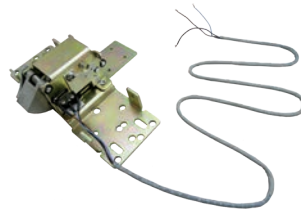

LATCH BOLT MONITOR



BATTERY POWERED ALARM

Pricing*



CODE	DESCRIPTION
AL LHR	Alarm Option, Left Hand Reverse
AL RHR	Alarm Option, Right Hand Reverse
LM	Latch Bolt Monitoring (6200R Only)
MLR	Motorized Latch Retraction
SS	Signal Switch - Request to Exit or Monitoring
SS-2	Dual Signal Switch - Request to Exit and Monitoring

*Contact Customer Service for Discount



6EW199A

Electrified Exit Device Trim



**ASSEMBLED
IN THE USA**

Typical Applications

- Healthcare
- High Security Areas
- Higher Education
- Industrial
- K-12 Education
- Stairwell Towers



MOTORIZED LOCKING/UNLOCKING



Innovative motor drive controls FAIL SECURE or FAIL SAFE locking mode

Features

- Available in 6200 EW Series Wide Stile Escutcheon Trim
- Motorized locking/unlocking.
FAIL SECURE – Outside trim is UNLOCKED when power is ON, and LOCKED when power is OFF. Lockset will lock in the event of a power failure
FAIL SAFE – Outside trim is LOCKED when power is ON, and UNLOCKED when power is OFF. Lockset will unlock in the event of a power failure.
- Field changeable from FAIL Secure to FAIL SAFE.
- Designed for AC or DC input voltage. No need to select voltage when specifying or ordering.
- Designed for use with PDQ Rim, Surface Vertical Rod and Concealed Vertical Rod Exit Devices only. Not available with Mortise Exit Devices
- Designed and assembled by PDQ in the USA



Specifications

• Input voltage: 12-24VDC or 12-24VAC.

• Max In-rush current: < 1.0A.

• Standby current:

- 12VAC: 12mA.
- 24VAC: 10mA.
- 12VDC: 3mA.
- 24VDC: 4mA.

Note: Operating voltage at $\pm 10\%$ of rated voltage.

• Warranty: 2-Years

Recommended Power Supply

• PDQ Model # 81440.
– Input: 120VAC, .9A, 50/60Hz 240VAC, .6A, 50/60Hz
– Output: 24VDC, 2A, filtered and regulated.

• Rated for simultaneous operation of 2 each trim assys.

• Power Supply Requirements:
– AC/DC Output Voltage – 1A min (filtered and regulated).

• 12-24VDC @ < 1A initial surge (1 sec), 5mA standby after 30 sec.
– AC Output Voltage.

• 12-24VAC (60Hz) @ < 1A initial surge (1 sec), 15mA standby after 30 sec

6EW199A ELECTRIFIED EXIT DEVICE TRIM MOTORIZED LOCKING/UNLOCKING

LIST PRICE

Effective July 15, 2019

PDQ Functions

FUNCTION	FUNCTION NUMBER	DESCRIPTION	ANSI
Electrified Storeroom	 199A	<ul style="list-style-type: none"> • Key outside momentarily unlocks outside lever • Fail secure (default) – power to unlock – outside lever unlocked when power is applied • Fail safe (field selectable) – power to lock – outside lever unlocked when power is removed 	09

Levers



PHILADELPHIA — PHL



BOSTON — BSN



CHICAGO — CHI



MIAMI — MIA



ORLANDO — ORL



How to Order

QUANTITY	SERIES	TYPE	FUNCTION	LEVER	HANDING	FINISH	CYLINDER OR HOUSING	KEYWAY	KEYING	OPTIONS
10	6	EW	199A	PHL	—	626	D	SCC	KD	—
Notes: 1 - List price includes standard default cylinder 2 - 6EW Trim ordered less cylinder includes collar and spring washer for cylinder lengths 1-1/8" to 1-1/4".		EW — Escutcheon, Wide	199A — Electrified Storeroom w/Lever	BSN — Boston CHI — Chicago MIA — Miami ORL — Orlando PHL — Philadelphia	RHR LHR	605 — Bright Brass 606 — Satin Brass 613 — Oil Rubbed Bronze 625 — Bright Chrome 626 — Satin Chrome	D — Default L — Less Cylinder SF6 — SFIC w/Core, 6 Pin SF7 — SFIC w/Core, 7 Pin LF — Schlage® Compatible LFIC w/Core SF6L — SFIC 6 Pin Housing less core SF7L — SFIC 7 Pin Housing less core LFL — Schlage® Compatible LFIC Housing less core			AM — Antimicrobial Coating

6EW199A ELECTRIFIED EXIT DEVICE TRIM MOTORIZED LOCKING/UNLOCKING

LIST PRICE

Effective July 15, 2019

ELECTRONIC ACCESS CONTROL
ELECTRONIC LOCKING TRIM

Escutcheon Trim



TYPE	FUNCTION	DESCRIPTION	TRIM TYPE	605	606	613 619	625	626
Rim Surface Vertical Rod Concealed Vertical Rod	09	Storeroom w/ Lever	6 EW 199A (BSN, MIA, ORL or PHL)			\$1135*		\$1120*

Parts discount applies. *Contact Customer Service for Discount

Options

CODE	DESCRIPTION	LIST PRICE*
AM	Antimicrobial coating applied to tactile surfaces	\$62

Parts discount applies. *Contact Customer Service for Discount

Default Trim Cylinder Reference Guide

ANSI FUNCTION	DESCRIPTION	CYLINDER
09	Storeroom w/Lever	Mortise

How to Order



QUANTITY	SERIES	MATERIAL	STYLE	SIZE	FINISH	SECURITY FEATURE ²	ELECTRIFIED OPTIONS ¹
10	35	ST	BB	4545	630	NRP	—
Ordering example: Plain bearing hinge: 35 ST BB 4545 630 NRP 4 Wire Std Weight Hinge: EL 4 35 SS BB 4545 630 NRP Notes: 1- EL Series only available in 2 and 4 ball bearing. Includes NRP. 2 - NRP only available in 2 and 4 ball bearing. 3 - Not available in 4 ball bearing heavy weight hinges.	35 — Full Mortise	ST — Steel SS — Stainless Steel	BB — 2 Ball Bearing HB — 4 Ball Bearing	4545 — 4-1/2" X 4-1/2" 5045 — 5" x 4-1/2"	600 — Prime Coated 605 — Bright Brass 613 — Oil Rub Bronze 626 — Satin Chrome 630 — Satin Stainless Steel	NRP — Non Removable Pin	EL 2 — Concealed electric through-wire (2 wire, 22 ga) EL 4 — Concealed electric through-wire (4 wire, 28 ga) EL 10 — Concealed electric through-wire (10 wire, 28 ga) EL 24 — Concealed electric through-wire (2 wires @ 22 ga, 4 wires @ 28ga) ELM 3 — Concealed electric monitor (3 wire, 28 ga) ELM 4 — Concealed electric through-wire and monitor (4 through wires and 3 monitor wires, all 28GA) ELM 6 — Concealed electric through-wire and monitor (6 through wires and 3 monitor wires, all 28GA) ELM 8 — Concealed electric through-wire and monitor (8 through wires and 3 monitor wires, all 28GA)

Hinge Pricing

PART NUMBER	DESCRIPTION	LIST*	PART NUMBER	DESCRIPTION	LIST*
35SSBB4545-630NRP	HINGE,SS BALL 630 4545 NRP	\$47.90	35STHB4545-600NRP	HINGE,ST HD BALL 600 4545 NRP	\$33.90
35SSHB4545-630NRP	HINGE,SS HD BALL 630 4545 NRP	\$74.50	35STHB4545-605NRP	HINGE,ST HD BALL 605 4545 NRP	\$37.28
35SSHB5045-630NRP	HINGE,SS HD BALL 630 5045 NRP	\$95.20	35STHB4545-613NRP	HINGE,ST HD BALL 613 4545 NRP	\$37.28
35STBB4545-600NRP	HINGE,ST BALL USP 4545 NRP	\$14.28	35STHB4545-619NRP	HINGE,ST HD BALL 619 4545 NRP	\$33.90
35STBB4545-605NRP	HINGE,ST BALL 605 4545 NRP	\$20.28	35STHB4545-626NRP	HINGE,ST HD BALL 626 4545 NRP	\$33.90
35STBB4545-613NRP	HINGE,ST BALL 613 4545 NRP	\$18.80	35STHB5045-613NRP	HINGE,ST HD BALL 613 5045 NRP	\$45.10
35STBB4545-619NRP	HINGE,ST BALL 619 4545 NRP	\$14.28	35STHB5045-626NRP	HINGE,ST HD BALL 626 5045 NRP	\$42.28
35STBB4545-626NRP	HINGE,ST BALL 626 4545 NRP	\$14.28			

*List price is per hinge
*Contact Customer Service for Discount

Electrified Options

	FEATURES	QTY OF HINGES PER CARTON	CODE	DESCRIPTION	HINGE ADJUSTMENT
 	UL LISTED UL Fire Listed for use with electrified mortise or cylindrical locks, exit devices with electric latch retraction, electric Strikes, locks or exit devices with monitoring or request to exit switches Electrical Specifications Concealed electric through-wire: 50 volts AC/DC @ 3.5 amps contiguous, 16 amps pulse (maximum pulse width:400msec.,10 sec minimum off time between pulses)Concealed electric monitor: 30 VDC @ .5 amps	1ea	EL 2	Concealed electric through-wire (2 wires, 22GA)	\$720
			EL 4	Concealed electric through-wire (4 wires, 28GA)	\$570
			EL 10	Concealed electric through-wire (10 wires, 28GA)	\$745
			EL 24	Concealed electric through-wire (2 wires @ 22GA, 4 wires @ 28GA)	\$742
			ELM 3	Concealed electric monitor (3 wires, 28GA)	\$616
			ELM 4	Concealed electric through-wire and monitor (4 through wires and 3 monitor wires, all 28GA)	\$930
			ELM 6	Concealed electric through-wire and monitor (6 through wires and 3 monitor wires, all 28GA)	\$1080
			ELM 8	Concealed electric through-wire and monitor (8 through wires and 3 monitor wires, all 28GA)	\$1120

8500 SERIES

Electric Strikes



Specifications

85001 ELECTRIC STRIKE:	<ul style="list-style-type: none"> • Designed for use with all PDQ Grade 1 and Grade 2 Cylindrical Locks
85003 ELECTRIC STRIKE:	<ul style="list-style-type: none"> • Designed for use with all PDQ MR Series Mortise Locks WITHOUT Deadbolt
FEATURES:	<ul style="list-style-type: none"> • Input voltage: 12-24 VD • Field changeable from FAIL SECURE to FAIL SAFE • Factory tested to 1,000,000 cycle
CURRENT:	<ul style="list-style-type: none"> • 0.28A @ 12VD • 0.14A @ 24 VDC
FINISH:	<ul style="list-style-type: none"> • 630 (US32D) Satin Stainless Steel

Electric Strikes

Designed for use with PDQ's Grade 1 Mortise Locks, Grade 1 and 2 Cylindrical Locks

PART NO.	DESCRIPTION	LIST*
85001	For Cylindrical Locks	\$486
85003	For Mortise locks (no Deadbolt)	

NOTE: Check with Factory for other finishes.

Parts discount applies

*Contact Customer Service for Discount

8100 SERIES

Key Switches Push Buttons

Typical Applications

- Assisted Living
- Detention Facilities
- Healthcare
- Higher Education
- K-12 Education
- Offices



KEY SWITCH W/LIGHTS
81310-2MT / 81310-2MM



KEY SWITCH
81310-4MT / 81310-4MM



PUSH BUTTON SWITCH
81320-1MT / 81320-1MM



PUSH BUTTON SWITCH
81320-6MT / 81320-6MM



MUSHROOM PUSH BUTTON
81320-5MT / 81320-5MM

Electrified Accessories

PART NUMBER	DESCRIPTION	PART LIST PRICE*
81310-2MT	62 Key Switch with Lights Maintained	\$290
81310-2MM	62 Key Switch with Lights Momentary	
81310-4MT	62 Key Switch Narrow Maintained	\$264
81310-4MM	62 Key Switch Narrow Momentary	
81320-1MT	62 Push Button Maintained	\$185
81320-1MM	62 Push Button Momentary	
81320-5MT	62 Push Button Mushroom Maintained	\$282
81320-5MM	62 Push Button Mushroom Momentary	
81320-6MT	62 Push Button Narrow Maintained	\$211
81320-6MM	62 Push Button Narrow Momentary	

Parts discount applies

*Contact Customer Service for Discount

81440 SERIES

Power Supplies



Features



- Filtered/Regulated 24 Volts DC
- Up to Full 2 Amps Load Capacity
- Class 2 Rated Outputs
- Overload, Over Voltage and Short Circuit Protection
- Automatically Accepts 120VAC or 240VAC Input Without Requiring to Move Jumpers or Set Dip Switches
- Controls Fail Safe or Fail Secure Locking Devices
- Interface Relay Isolates Locking Device Current from Control Switch
- Auxiliary 24VDC Constant Voltage Output for Powering Stand Alone Devices, Such as, Keypads, Motion Detectors and Status Indicators
- Surge Suppression on Fail Safe and Fail Secure Outputs
- UL Listed and Tested to 294 Standard for Access Control System Units

OPTION	DESCRIPTION	PART LIST PRICE*
81440	Power Supply	\$668

Parts discount applies. *Contact Customer Service for Discount

pdq SMART

Terms of Service



This Price List Supersedes and Cancels all Previous Price Lists. Prices Shown are Subject to Change without Notice.

Terms & Conditions

Prices

All prices are subject to change without notice. All prices are per unit (each) unless otherwise specified and do not include freight.

Errors and Omissions

While PDQ Manufacturing makes every effort to provide an accurate price list, we are not responsible for errors and/or omissions that may appear. Customers will be invoiced the actual and true price on all orders.

Credit Terms

Standard credit terms are 1% 10 days net 30. Net 30 days payment must be received by PDQ on or before 30 days from the date of the invoice. Interest will be charged at the rate of 1-1/2% per month on past due accounts. A \$25.00 fee will be charged for all returned payments.

Acceptance of Orders

Possession of prices from PDQ Manufacturing does not commit PDQ to accept any order. PDQ Industries reserves the right to refuse any order or request for quotation and will not be bound to fill any order until it has been accepted by a representative of PDQ and confirmed by a written acknowledgment. Quotations are valid for the period stated on the official quotation request form. Orders must be submitted in writing.

Acknowledgments

An Acknowledgment is an exact copy of a customer's order as entered by PDQ and should be verified by the customer. If the Acknowledgment does not agree with customer's understanding, PDQ should be advised within three (3) days or the order will be billed as acknowledged. PDQ Manufacturing's sales terms shall apply irrespective of any special stipulation appearing in customer orders, unless specifically acknowledged and accepted by PDQ Manufacturing, Inc. Estimates of delivery are made by PDQ Manufacturing in good faith and are not guaranteed. PDQ Manufacturing does not assume responsibility for delay in deliveries.

Product will Call Orders

Product Will Call orders shall be picked-up within 3 working dates from the available date shown on the acknowledgment. Orders not picked-up after the 3 days shall be subject to cancellation charges.

Product Return

Products may not be returned unless customer receives written authorization from PDQ. If the return is authorized by PDQ a Return Goods Authorization (RGA) number will be issued to the customer. Products returned must have the RGA number clearly marked on the outside of the box and reach PDQ within 45 days from the date RGA is issued. All documentation and RGA number must accompany the return along with the original invoice number and an explanation why the material is being returned so that PDQ may inspect the material in question. Only material that has been in customer's inventory for less than 60 days from the invoice date, is current standard, non-obsolete and not specially manufactured, unused and in their original condition and original packaging will be considered for return. Master keyed items cannot be returned for credit. If the product is accepted for a return there will be minimum 35% processing charge of the net material value on the original invoice, less freight and cash discounts. Full credit against future purchases or replacements will be made at the option of PDQ. Care must be taken to package all returns to ensure that they are not damaged in shipment. PDQ will not credit items returned that have not been properly packed and as a result sustain damage in shipment back to our facility.

Force Majeure

PDQ will not be held responsible for delays in delivery caused by strikes, acts by government agencies, fires, floods or any other causes beyond our control, including the delivery of material to us. Under no circumstances shall PDQ be liable or accountable for consequential damages due to failure of delivery.

Invoices

Copies of invoices and sales orders are posted and accessible on PDQ's website. Contact Customer Service on for obtaining secured access authorization.

Minimum Order

Minimum order is \$100 net invoice value at current buying program, less freight. Orders less than \$100 will be subject to parts discount.

Changes or Cancellations

Changes or cancellations to an order acknowledged must be made in writing subject to a 50% cancellation fee.

Claims

Every possible care is taken in the final examination and packing of goods, and no complaints can be entertained unless made promptly on receipt of goods. No claim will be allowed for work done by others, consequential damages, or other expenditure, and PDQ's undertaking to repair or replace defective goods is its only liability. No claim for damage, shortage or loss in transit will be considered unless notice in writing is given to the carrier and to PDQ Industries within ten (10) days.

Back Charges

PDQ is not responsible for, does not authorize, and will not accept any charges for the cost of labor or material incurred by anyone other than PDQ Manufacturing for any installation, repair, service or replacement unless incurred with PDQ's prior written consent and agreement.

Freight Charges

FOB point is Lancaster, PA, Norcross, GA, Kansas City, MO, Denver, CO, Henderson, NV or Auburn, WA. Ship location is at factory discretion. Freight charges are prepaid and added to invoice. If invoice exceeds \$1,900 Net, full surface freight (UPS or truck) within contiguous U.S.A. is deductible, provided invoice is paid within terms. Air freight and other special shipments are not deductible. Freight allowance methods are at the discretion of PDQ. C.O.D. freight charges are paid by consignee.

Credit Card Payments

When paying by credit card a 3% surcharge will be added to the invoice at time of payment.

Discontinuance

PDQ Manufacturing, Inc. reserves the right to discontinue or change any price, product, design, function and finish without notice.

Quotations and Invoices

Quotations and Invoices are the proprietary property of PDQ Distributors and the Company. Distributors are not permitted to redistribute quotations or invoices to third parties. Any redistribution may result in the loss of the distributor's rights to the PDQ product line.

pdqSMART License Agreement

LICENSE AGREEMENT

(effective date 11/3/17 rev2)

This End User License Agreement ("EULA") is a legal agreement between you and PDQ Manufacturing, Inc. ("PDQ Smart") for the PDQ Smart software ("Software") embedded on your PDQ Smart electronic physical access control products ("Hardware").

IF YOU DO NOT AGREE WITH ANY OF THE PROVISIONS OF THESE TERMS, YOU MUST CEASE USING AND ACCESSING THE SOFTWARE IMMEDIATELY. BY ACCESSING AND USING THE SOFTWARE IN ANY MANNER, YOU ARE ACCEPTING AND AGREEING TO THIS EULA ON BEHALF OF YOURSELF OR THE ENTITY YOU REPRESENT IN CONNECTION WITH SUCH ACCESS. YOU REPRESENT AND WARRANT THAT YOU HAVE THE RIGHT, AUTHORITY, AND CAPACITY TO ACCEPT AND AGREE TO THIS EULA ON BEHALF OF YOURSELF OR THE ENTITY YOU REPRESENT. YOU REPRESENT THAT YOU ARE OF SUFFICIENT LEGAL AGE IN YOUR JURISDICTION OR RESIDENCE TO USE OR ACCESS THE SOFTWARE AND TO ENTER INTO THIS EULA. Use of the Hardware, the Software and the PDQ Smart services provided in connection with the Hardware and the Software may also be subject to PDQ Smart's Terms of Service ("Terms of Service"), Privacy Policy ("Privacy Policy"), Limited Warranty ("Warranty"), and such other terms, conditions and instructions that may be provided by PDQ Smart from time to time. Please review all such terms and policies carefully before using any of PDQ Smart's products or services ("PDQ Smart Services"). By using the Software you are agreeing to the terms of all of the above-listed terms and conditions that apply to you.

AS DESCRIBED BELOW, YOU ARE CONSENTING TO AUTOMATIC UPDATING OF THE SOFTWARE. IF YOU DO NOT AGREE, YOU SHOULD NOT USE THE SOFTWARE. Any future release, update, or other addition or change to functionality of the Software shall be subject to the terms of this EULA, unless PDQ Smart expressly states otherwise. Your continued use of the Software is your agreement to the terms and conditions set forth in this EULA.

- LICENSE GRANT.** Subject to the terms and conditions of this EULA, PDQ Smart grants to you a nontransferable, nonexclusive, revocable, worldwide (subject to any legal restrictions on export or use) license (without the right to sublicense) to download and run the Software, solely on the Hardware that you own or control, in connection with your use of such Hardware, in accordance with this EULA and any other terms and conditions made available by PDQ Smart in connection with the Hardware, Software and related PDQ Smart Services.
- CONDITIONS OF USE; LICENSE RESTRICTIONS.** You agree to abide by, and to use the Hardware and Software in accordance with, the documentation provided to you in connection with the Hardware and Software, and any additional terms of service that PDQ Smart may post associated with the PDQ Smart Services, including without limitation the Terms of Service. You are responsible for maintaining the security of your Hardware, and you must take reasonable steps to protect access to the Hardware and Software. All use of the Hardware and Software (by you or others) through your account with PDQ Smart is your responsibility. Your use of the Hardware and Software is subject to the following restrictions: (a) you shall use the Hardware and Software solely as licensed above, and shall not license, sell, rent, lease, transfer, assign, distribute, host, outsource, disclose or otherwise commercially exploit the Hardware or Software or make the Software available to any third party for any use outside of the Hardware or as otherwise intended by this EULA, the Terms of Service and Warranty; (b) you shall not modify, make derivative works of, disassemble, reverse compile or reverse engineer any part of the Hardware or Software (except solely to the extent affirmatively required under applicable statutory law); (c) you shall not use or access the Hardware or Software for benchmarking or competitive analysis, or in order to build a similar or competitive product or service; (d) except as expressly stated herein, you shall not copy, reproduce, distribute, republish, download, display, post, or transmit the Hardware or Software in any form or by any means, including but not limited to electronic, mechanical, photocopying, recording or other means and (e) you shall only use the Hardware and Software in compliance with all applicable local laws, rules and regulations, including without limitation all building codes and regulations.
- AUTOMATIC SOFTWARE UPDATES.** PDQ Smart may from time to time develop patches, bug fixes, updates, upgrades and other modifications to improve the performance of the Software and related services ("Updates"). You consent to the automatic installation of the Software on the Hardware, which may occur without PDQ Smart providing any additional notice or receiving any additional consent. If you do not want such Updates, your remedy is to stop using the Software. If you do not cease using the Software, you will receive Updates automatically. You acknowledge that you may be required to install Updates to use certain features or components of the Hardware, including the Software, and you agree to promptly install any Updates PDQ Smart requires or makes available to you.
- OWNERSHIP.** PDQ Smart and its suppliers and licensors own and retain all right, title and interest in and to the Software, including all intellectual property rights thereto and reserve all rights not expressly granted in this EULA. The Software (and all copies thereof) is licensed to you, not sold, under this EULA. You acknowledge that any suggestions, ideas, comments or other feedback ("Feedback") you provide to us regarding the Hardware or Software shall become our sole and exclusive property without any compensation to you. We may, in our sole discretion, decide whether to use the Feedback in any of our products and services. You hereby assign to us all of your right, title and interest in the Feedback, including but not limited to all copyrights, patent rights, trade secrets and trademarks.
- OPEN SOURCE.** The Software may contain or be distributed with open source software which may be covered by a different license. You agree that all such open source software is and shall remain subject to the terms and conditions under which it is provided, and you are and shall be responsible for compliance with such terms.
- PRIVACY.** The Software may automatically transmit personal, usage and status data to PDQ Smart's servers to enable its functionality. Information provided to PDQ Smart in connection with your use of the Software is covered by our Privacy Policy. Please review the Privacy Policy prior to using the Software. By entering into this EULA and using the Software, you are agreeing to the collection and use of your information as set forth in the Privacy Policy.
- INDEMNITY.** You agree that PDQ Smart shall have no liability whatsoever for any use you make of the Software. You shall indemnify and hold harmless PDQ Smart from any third party claims, damages, liabilities, costs and fees (including reasonable attorney fees) arising from your use of the Software in a manner that does not comply with the terms of this EULA.
- WARRANTY DISCLAIMER.** YOU EXPRESSLY ACKNOWLEDGE AND AGREE THAT, TO THE EXTENT PERMITTED BY APPLICABLE LAW, USE OF THE SOFTWARE IS AT YOUR SOLE RISK AND THAT THE ENTIRE RISK AS TO SATISFACTORY QUALITY, PERFORMANCE, ACCURACY AND EFFORT IS WITH YOU. THE SOFTWARE IS PROVIDED "AS IS" AND WITHOUT WARRANTY OF ANY KIND, AND PDQ SMART DOES NOT MAKE ANY, AND HEREBY DISCLAIMS ALL, EXPRESS OR IMPLIED WARRANTIES, INCLUDING WITHOUT LIMITATION ANY AND ALL WARRANTIES OF MERCHANTABILITY, FITNESS FOR A PARTICULAR PURPOSE, PERFORMANCE, ACCURACY, RELIABILITY, AND NON-INFRINGEMENT. THIS DISCLAIMER OF WARRANTY CONSTITUTES AN ESSENTIAL PART OF THIS EULA. SOME STATES DO NOT ALLOW LIMITATIONS ON HOW LONG AN IMPLIED WARRANTY LASTS SO THE FOREGOING LIMITATIONS MAY NOT APPLY TO YOU.
- LIMITATION OF LIABILITY.** TO THE MAXIMUM EXTENT PERMITTED BY LAW, NEITHER PDQ SMART NOR ITS SUPPLIERS OR LICENSORS SHALL BE RESPONSIBLE OR LIABLE WITH RESPECT TO ANY SUBJECT MATTER OF THIS EULA OR TERMS OR CONDITIONS RELATED THERETO UNDER BREACH OF CONTRACT, NEGLIGENCE, STRICT LIABILITY OR ANY OTHER THEORY FOR ANY (A) LOSS OR INACCURACY OF DATA OR COST OF PROCUREMENT OF SUBSTITUTE GOODS, SERVICES OR TECHNOLOGY; (B) INDIRECT, INCIDENTAL OR CONSEQUENTIAL DAMAGES INCLUDING, BUT NOT LIMITED TO, BUSINESS INTERRUPTION, LOSS OF REVENUES AND LOSS OF PROFITS OR (C) ANY AMOUNTS THAT EXCEED, IN THE AGGREGATE, THE AMOUNT PAID BY YOU FOR THE SOFTWARE THAT CAUSED SUCH DAMAGE IN THE TWELVE (12) MONTHS IMMEDIATELY PRIOR TO SUCH CLAIM ARISING. THE FOREGOING SHALL APPLY EVEN IF PDQ SMART KNEW OR SHOULD HAVE KNOWN OF THE POSSIBILITY OF SUCH DAMAGES. UNLESS PROHIBITED BY LAW, PDQ SMART SHALL NOT BE LIABLE FOR ANY CLAIM OR CAUSE OF ACTION ARISING OUT OF OR RELATED TO USE OF THE HARDWARE OR SOFTWARE, OR THIS EULA, MORE THAN ONE (1) YEAR AFTER SUCH CLAIM OR CAUSE OF ACTION AROSE.
- CERTAIN STATES AND/OR JURISDICTIONS DO NOT ALLOW THE EXCLUSION OF IMPLIED WARRANTIES OR LIMITATION OF LIABILITY FOR INCIDENTAL OR CONSEQUENTIAL DAMAGES, SO THE EXCLUSIONS AND/OR LIMITATIONS SET FORTH ABOVE MAY NOT APPLY TO YOU.**
- TERM AND TERMINATION.** This EULA and the licenses granted hereunder are effective on the date you first install or use the Software and shall continue unless and until you or PDQ Smart terminates this EULA pursuant to this section. PDQ Smart may terminate this EULA at any time if you fail to comply with any term(s) hereof. You may terminate this EULA effective immediately upon providing PDQ Smart with written notice. Upon termination, the license granted to you for use of the Software shall terminate and you will no longer have any rights to use the Software. Upon termination, you shall immediately destroy any copies of the Software in your possession. All provisions of this EULA which by their nature should survive termination shall survive termination, including, without limitation ownership provisions, warranty disclaimers, indemnity and limitations of liability. For clarity, there will be no refunds in the event this EULA is terminated.

pdqSMART License Agreement (Cont.)

12. EXPORT. You agree to comply with all U.S. and foreign export laws and regulations to ensure that neither the Software or Hardware, nor any technical data related thereto nor any direct product thereof is exported or re-exported directly or indirectly in violation of, or used for any purposes prohibited by, such laws or regulations. By using the Hardware or Software you represent and warrant that: (a) you are not located in a country that is subject to a U.S. Government embargo, or that has been designated by the U.S. Government as a "terrorist supporting" country; and (b) you are not listed on any U.S. Government list of prohibited or restricted parties.
13. CONFIDENTIALITY. "Confidential Information" shall mean the Software and all other information disclosed to you that PDQ Smart characterizes as confidential at the time of its disclosure or which would be reasonably understood to be confidential given the nature of the information and the circumstances surrounding its disclosure. You shall use your best efforts, but no less than reasonable care, to preserve and protect the confidentiality of the Confidential Information at all times during the term of this EULA and until you can document the Confidential Information becomes generally known to the public through no act or failure to act on your part. You shall not disclose, disseminate or otherwise publish or communicate Confidential Information to any third party without the prior written consent of PDQ Smart. You shall not use any Confidential Information other than in the course of the activities permitted by PDQ Smart hereunder. You shall notify PDQ Smart in writing immediately upon discovery of any unauthorized use or disclosure of Confidential Information or any other breach of this EULA and will cooperate with PDQ Smart in every reasonable way to regain possession of Confidential Information and prevent any further unauthorized use. If you are legally compelled to disclose any of the Confidential Information, to the extent permitted by applicable law, rule or regulation, you will (a) notify PDQ Smart prior to such disclosure to allow PDQ Smart an opportunity to contest the disclosure; (b) cooperate fully with PDQ Smart in protecting against any such disclosure or obtaining a protective order narrowing the scope of such disclosure and (c) in the event such protection is not obtained, disclose only the Confidential Information necessary to comply with the applicable legal requirements.
14. U.S. GOVERNMENT END USERS. The Software is a "commercial item," as that term is defined at 48 C.F.R. 2.101 (OCT 1995), and more specifically is "commercial computer software" and "commercial computer software documentation," as such terms are used in 48 C.F.R. 12.212 (SEPT 1995). Consistent with 48 C.F.R. 12.212 and 48 C.F.R. 227.7202-1 through 227.7202-4 (JUNE 1995), the Software is provided to U.S. Government End Users only as a commercial end item and with only those rights as are granted to all other customers pursuant to the terms and conditions herein.
15. GOVERNING LAW AND JURISDICTION. This EULA shall be governed by and construed in accordance with the laws of the State of Pennsylvania, including its conflicts of law rules, and the United States of America. You agree that any dispute arising from or relating to the subject matter of this EULA shall be resolved in Lancaster County, Pennsylvania.
16. ARBITRATION AND CLASS ACTION WAIVER – IMPORTANT – PLEASE REVIEW AS THIS AFFECTS YOUR LEGAL RIGHTS:
- a. ARBITRATION. YOU AGREE THAT ALL DISPUTES BETWEEN YOU AND US (WHETHER OR NOT SUCH DISPUTE INVOLVES A THIRD PARTY) WITH REGARD TO YOUR RELATIONSHIP WITH US, INCLUDING WITHOUT LIMITATION DISPUTES RELATED TO THIS EULA AND THE LICENSES GRANTED HEREUNDER, YOUR USE OF THE SOFTWARE, AND/OR RIGHTS OF PRIVACY AND/OR PUBLICITY, WILL BE RESOLVED BY BINDING, INDIVIDUAL ARBITRATION IN ACCORDANCE WITH THE STREAMLINED ARBITRATION RULES AND PROCEDURES OF THE JAMS ALTERNATE DISPUTE RESOLUTION GROUP THEN IN EFFECT, AND YOU AND WE HEREBY EXPRESSLY WAIVE TRIAL BY JURY; PROVIDED, HOWEVER, THAT TO THE EXTENT THAT YOU HAVE IN ANY MANNER VIOLATED OR THREATENED TO VIOLATE OUR INTELLECTUAL PROPERTY RIGHTS, WE MAY SEEK INJUNCTIVE OR OTHER APPROPRIATE RELIEF IN ANY STATE OR FEDERAL COURT IN THE STATE OF PENNSYLVANIA. DISCOVERY AND RIGHTS TO APPEAL IN ARBITRATION ARE GENERALLY MORE LIMITED THAN IN A LAWSUIT, AND OTHER RIGHTS THAT YOU AND WE WOULD HAVE IN COURT MAY NOT BE AVAILABLE IN ARBITRATION. AS AN ALTERNATIVE, YOU MAY BRING YOUR CLAIM IN YOUR LOCAL "SMALL CLAIMS" COURT, IF PERMITTED BY THAT SMALL CLAIMS COURT'S RULES AND IF WITHIN SUCH COURT'S JURISDICTION, UNLESS SUCH ACTION IS TRANSFERRED, REMOVED OR APPEALED TO A DIFFERENT COURT. YOU MAY BRING CLAIMS ONLY ON YOUR OWN BEHALF. NEITHER YOU NOR WE WILL PARTICIPATE IN A CLASS ACTION OR CLASS-WIDE ARBITRATION FOR ANY CLAIMS COVERED BY THIS AGREEMENT TO ARBITRATE. YOU ARE GIVING UP YOUR RIGHT TO PARTICIPATE AS A CLASS REPRESENTATIVE OR CLASS MEMBER ON ANY CLASS CLAIM YOU MAY HAVE AGAINST US INCLUDING ANY RIGHT TO CLASS ARBITRATION OR ANY CONSOLIDATION OF INDIVIDUAL ARBITRATIONS. You also agree not to participate in claims brought in a private attorney general or representative capacity, or consolidated claims involving another person's account, if we are a party to the proceeding. This dispute resolution provision will be governed by the Federal Arbitration Act and not by any state law concerning arbitration. Judgment on the award rendered by the arbitrator may be entered in any court having competent jurisdiction. Any provision of applicable law notwithstanding, the arbitrator will not have authority to award damages, remedies or awards that conflict with this EULA.
- b. 30-Day Opt-Out Period. If you do not wish to be bound by the arbitration and class-action waiver provisions in this Section 16, you must notify PDQ Smart in writing within 30 days of the date that you first accept this EULA (unless a longer period is required by applicable law). Your written notification must be mailed to PDQ Smart at the following address: PDQ Smart 2754 Creek Hill Road, PA 17540. If you do not notify PDQ Smart in accordance with 16(b), you agree to be bound by the arbitration and class-action waiver provisions of this EULA, including such provisions in this EULA revised after the date of your first acceptance. Such notification must include: (i) your name, (ii) your PDQ Smart Account number; (iii) your mailing address, and (iv) a statement that you do not wish to resolve disputes with PDQ Smart through arbitration. If PDQ Smart makes any changes to the Arbitration and Class Action Waiver section of this EULA (other than a change to the address at which PDQ Smart will receive notices of dispute, opt-out notices, or rejections of future changes to the Arbitration and Class Action Waiver section), you may reject any such change by sending us written notice within 30 days of the change to the address set forth in this Section 16(b). It is not necessary to send us a rejection of a future change to the Arbitration and Class Action Waiver section of this EULA if you had properly opted out of the arbitration and class-action waiver provisions in this Section 16 within the first 30 days after you first accepted this EULA. If you have not properly opted out of the arbitration and class-action waiver provisions in this Section 16, by rejecting a future change, you are agreeing that you will arbitrate any dispute between us in accordance with the language of this arbitration provision, as modified by any changes you did not reject. This notification affects this EULA only; if you previously entered into other arbitration agreements with PDQ Smart or enter into other such agreements in the future, your notification that you are opting out of the arbitration provision in this EULA shall not affect the other arbitration agreements between you and PDQ Smart.
- c. Severability. If the prohibition against class actions and other claims brought on behalf of third parties contained above is found to be unenforceable, then all of the preceding language in this Arbitration and Class Action Waiver section will be null and void. This arbitration agreement will survive the termination of your relationship with us.
17. MISCELLANEOUS. This EULA, together with the Terms of Service and Privacy Policy and any other applicable documentation provided to you by PDQ Smart, are the entire agreement between you and us with respect to the Software and supersede all prior or contemporaneous communications and proposals (whether oral, written or electronic) between you and us with respect to the Software. If any provision of this EULA is found to be unenforceable or invalid, that provision will be limited or eliminated to the minimum extent necessary so that this EULA will otherwise remain in full force and effect and enforceable. The failure of either party to exercise in any respect any right provided for herein shall not be deemed a waiver of any further rights hereunder. This EULA is personal to you, and is not assignable, transferable or sublicensable by you except with our prior written consent. We may assign, transfer or delegate any of our rights and obligations hereunder without consent. We shall not be liable for any failure to perform our obligations hereunder where such failure results from any cause beyond our reasonable control, including, without limitation, mechanical, electronic or communications failure or degradation. No agency, partnership, joint venture, or employment relationship is created as a result of this EULA and neither party has any authority of any kind to bind the other in any respect. All notices under this EULA will be in writing and will be deemed to have been duly given when received, if personally delivered or sent by certified or registered mail, return receipt requested; when receipt is electronically confirmed, if transmitted by e-mail; or the day after it is sent, if sent for next day delivery by recognized overnight delivery service. Electronic notices should be sent to contact@PDQSmart.com. Our failure to enforce any part of this EULA shall not constitute a waiver of our right to later enforce that or any other part of this EULA. In order for any waiver of this EULA to be binding, we must provide you with written notice of such waiver through one of our authorized representatives. The section and paragraph headings in this EULA are for convenience only and shall not affect their interpretation. Any use of "including" "for example" or "such as" in this EULA shall be read as being followed by "without limitation" where appropriate.
18. QUESTIONS OR ADDITIONAL INFORMATION. If you have questions regarding this EULA, or wish to obtain additional information, please send an e-mail to contact@PDQSmart.com.

pdqSMART Privacy Policy

PRIVACY POLICY

(effective date 11/3/17 rev2)

PDQ Smart takes your privacy very seriously. We created this Privacy Policy ("Privacy Policy") to explain our treatment of the personally identifiable information ("PII") we collect when you use or access our products and services. It includes information about how PII is used and shared and about your choices regarding your PII. Please read this Privacy Policy carefully. When you use the Hardware and/or the Services, you are consenting to the collection, transfer, manipulation, storage, disclosure and other uses of your information as described in this Privacy Policy.

DEFINITIONS:

- PDQ Smart/we/our/us: "PDQ Smart", "we", "our" or "us", as used in this Privacy Policy means PDQ Manufacturing, Inc.
- Hardware: "Hardware" means products that contain PDQ Smart's proprietary technology, such as PDQ Smart electronic physical access control products.
- Services: "Services", as used in this Privacy Policy, includes:
 - o The Site: The PDQ Smart website accessible at <https://www.pdqlocks.com/about-pdqsmart/> ("Site")
 - o The PDQ Smart Portal website accessible at <https://portal.pdqlocks.com> ("Portal")
 - o The Mobile App: The software that can be downloaded to a user's computer, mobile phone or tablet ("Devices") to access the Services ("Mobile App", and together with all other applications offered by PDQ Smart in connection with PDQ Smart's services, the "Apps")
 - o Subscription Services: Subscription services provided by PDQ Smart, which may be accessible through the Apps or Portal ("Subscription Services")
- All other capitalized terms are either defined in this Privacy Policy or the Terms of Service.

SCOPE:

This Privacy Policy covers:

- PII collected when you, your Guests/Visitors or any other users or persons accessing the Services.
- PII that our business partners share with us or that we share with our business partners.

This Privacy Policy does not cover information collected by individuals or entities who provide third party websites, services or applications ("Third Party Services") or to individuals that we do not manage or employ, even if you access, encounter or interact with them through the Services (e.g. if you click on links to those Third Party Services on the Site or Apps). While we attempt to facilitate access only to those Third Party Services that share our respect for your privacy, we are not responsible for the privacy policies or practices of Third Party Services, and you are responsible for reading and understanding those Third Party Services' privacy policies.

USES OF INFORMATION:

We use information, including PII to:

- Personalize, improve and operate our business and the Services
- Better understand your needs and interests
- Fulfill requests you may make related to the Services, including the processing and facilitation of transactions you conduct on the Services
- Provide Service announcements
- Provide you with further information and offers from us or third parties
- Comply with our legal obligations, resolve disputes with users, enforce our agreements
- Protect, investigate and deter against fraudulent, harmful, unauthorized or illegal activity

TYPES OF INFORMATION COLLECTED:

We receive information about you from various sources, including:

- If you register for the Services, through your user account on the Services (your "Account")
- Your use of the Services generally
- Third party websites and services, such as any integrated service providers or third party social media services you use in connection with the Services

The type of information PDQ Smart collects from you depends on the type of user you are. For more information about user types, please review the Terms. However, most categories of information are collected across all user types, so it is important to read through all the categories of information below, in case they apply to you.

Account and Setup Information: When you create an Account, you will provide information that could be PII or that could otherwise identify you or your location. The exact categories of information you provide will depend on the type of Account but almost all Accounts will generally require you to provide the following:

- Name
- Address
- Password
- Email address
- Phone number
- Age
- Profile
- Relationship to other users (e.g. property manager, owner, tenant, roommate, family, etc.)

If you are a User, you may also need to provide information about your insurance policy status and carrier.

pdqSMART Privacy Policy (Cont.)

If you are an Owner, you may also need to provide your tax ID number and information about the lease term for each unit/space equipped with Hardware.

This information is used to provide you with the Services, and may be shared with other users or our business partners to provide you with the Services. For example, if you are a User or Owner granting access to a Guest, some of your Account profile information, such as your name and the address of the Hardware's location, may be shared with the Guest so that the Guest can correctly identify the location to which you are granting them access.

Guest/Visitor Information: Guests and Visitors can use a Guest/Visitor Code to access a location without registering for an Account, but Guests and Visitors who do register will provide much of the same Account and Setup Information as other registered users. Additionally, a User or Owner granting access to a Guest/Visitor may enter information about the person, such as:

- Name
- Phone number
- Email address
- Age
- Profile
- Relationship to the user

Additionally, the Hardware may capture and store video and/or photographic images of Guests/Visitors and other individuals (collectively, "Images") who interact with the Hardware. For example, certain Hardware may take a picture of a Guest/Visitor or record a video clip when he or she enters a Guest Code or uses their Device to unlock the Hardware.

Guest/Visitor information is shared with the applicable Hardware's User and Owner. More information about the sharing of Guest/Visitor information is provided in the "Information Shared With Other Users" section below.

By using the Services in any manner, a Guest/Visitor hereby expressly consents to the collection, storage, use and disclosure of their information, which may include PII, in accordance with this Privacy Policy. If you are a Guest/Visitor and do not consent to any of the foregoing, you must not use or access the Services, including any Hardware.

If you are a User or Owner, please ensure that you have a Guest/Visitor's consent to the collection, use, storage, and disclosure of their information, including their Images, in accordance with this Privacy Policy before (i) providing such information to the Services or (ii) inviting such Guest/Visitor to use the Services, including by granting them access through a Guest/Visitor Code. By inviting a Guest/Visitor to use the Services or providing a Guest with a Guest Code through the Services, you represent and warrant that you have all necessary consent to share such Guest/Visitor's information, including their PII, with PDQ Smart for use in accordance with this Privacy Policy.

Device and Application Information: We may collect some Device-specific information when you access the Services using a Device, such as when a Device interacts with Hardware (e.g. when it unlocks or syncs with a PDQ Smart electronic physical access control product). Device information may include:

- Unique device identifiers
- Network information
- Hardware model
- Information about the ways in which the Device interacts with our services

We use Device information for Service support, maintenance and diagnostics, such as to troubleshoot issues with your Hardware or the Apps when you request support. We may share Device information with providers of Third Party Services in connection with such support.

Location Information: When you use certain features of the Services, such as the Apps, we may receive, store and process information about your location, including general information (e.g., IP address or zip code) and more specific information (e.g., GPS-based functionality on Devices used to access the Services). If you do not want your Device to provide us with location-tracking information, you can disable the GPS or other location-tracking functions on your Device. Please note that if you disable such functions, certain parts of the Services may not work.

Other Information Collected in Providing the Services: We collect information relating to the setup, general performance, and operation of our Services, including the Apps and the Hardware, including:

- Device status
- Access logs
- Frequency of use of internal and external services
- Frequency of Guest/Visitor Code creation and use

We use this information to operate, monitor, maintain and improve the Services, and to allow you to operate, monitor and maintain your Account and your Hardware (if applicable).

Usage of Service Providers: The Services may include integrations with Third Party Services (for example, a cleaning or delivery service to which you grant access). If you use these Third Party Service through our Services, we may collect and store information about your use of the integrated services. We use this information to improve our Services and may share the information with the Third Party Service providers to help them improve their products and services. Please note that we do not control these Third Party Service providers and cannot take responsibility for the content, privacy policies or practices of those Third Party Services.

Purchase and Financial Information: If you purchase one of our Services or otherwise make a purchase through the Services, we may request information that is necessary to process and complete the transaction, including:

- Name
- Email address
- Billing and shipping addresses
- Credit card information

We do not collect financial information, such as your payment method (valid credit card number, type, expiration date or other financial information); that information is collected and stored by our third party payment processing company (the "Payment Processor"), and use and storage of that information is governed by the Payment Processor's applicable terms of service and privacy policy.

pdqSMART Privacy Policy (Cont.)

We may from time to time request and receive some of your financial information from our Payment Processor for the following purposes:

- Completing transactions you have initiated through the Services
- Enrolling you in discount, rebate, and other programs in which you elect to participate
- Protecting against or identifying possible fraudulent transactions
- Otherwise as needed to manage our business

We use and disclose information collected in connection with your transactions to process and facilitate your order (or return, if applicable), which may require disclosure to our third party business partners.

Information Collected Using Cookies: Cookies are pieces of text that may be provided to your computer through your web browser when you access a website. Your browser stores cookies in a manner associated with each website you visit.

We use cookies to enable our servers to recognize your web browser and tell us how and when you visit the Site and otherwise use the Services. Our cookies do not, by themselves, contain PII, and we do not combine the general information collected through cookies with other PII to tell us who you are. We do use cookies to identify that your web browser has accessed aspects of the Services and may associate that information with your Account.

Most browsers have an option for turning off the cookie feature, which will prevent your browser from accepting new cookies, as well as (depending on the sophistication of your browser software) allowing you to decide on acceptance of each new cookie in a variety of ways. We strongly recommend that you leave cookies active, because they enable you to take advantage of the most attractive features of the Services.

This Privacy Policy covers our use of cookies only and does not cover the use of cookies by third parties. We do not control when or how third parties place cookies on your computer. For example, third party websites to which a link points may set cookies on your computer.

Information Collected From Web Beacons: We may deliver a file (known as a "web beacon") from an ad network to you through the Services to increase the effectiveness of ad delivery. Web beacons allow ad networks to provide anonymized, aggregated auditing, research and reporting for us and for advertisers. Web beacons also enable ad networks to serve targeted advertisements to you when you visit other websites. Because your web browser must request these advertisements and web beacons from the ad network's servers, these companies can view, edit or set their own cookies, just as if you had requested a web page from their site.

Non-PII: We may automatically collect and use information about the way users (both registered and unregistered) interact with the Services. Some of this information is derived from PII, but we anonymize or aggregate it so that it does not identify the individual from whom it was derived (resulting in "Non-PII"). Non-PII is not personally identifiable and cannot be tied back to the user from which it was obtained.

Non-PII enables us (and third parties we authorize) to figure out how and how often users engage with different parts of the Services so that we can analyze and improve them. We use Non-PII for:

- Industry analysis
- Marketing and advertising
- Facilitating collection of data concerning your interaction with the Services (e.g., what links you have clicked on)
- Fighting spam/malware/cyber disruptions
- Other business purposes (e.g., by reporting on trends in the usage of hardware and our Sites or Services)

We may share Non-PII with our partners, service providers and other persons with whom we conduct business so that our partners can understand how and how often people use our Services and our partners' services. These third parties may also share with us non-private, aggregated or other Non-PII about you that they have independently developed or acquired.

Email, Text, and Push Notification Communications: We may communicate with you via email, SMS, MMS or other text message ("Text Message") or using push notifications. We may collect information regarding such communications, such as by receiving confirmation when you open an email, read a Text Message or receive a push notification. We use this information to improve our Services, including our customer service.

Information About Your Contacts: For features in the Services that access your Device contact list, we will only store information for contacts who register with the Services or who you add as Guests. We will only access and store such information with your express consent.

Information About Children Under 13 Years of Age: Our Services are not directed to children under 13 years old and we do not knowingly collect PII from children under 13. If we learn that we have collected PII of or from a child under 13 years old, we will take steps to delete such information from our systems as soon as possible.

Other Ways Information is Shared:

In addition to the purposes set forth above, we may share your information for the following purposes:

Information Shared With Other Users: In connection with certain features of the Services, PDQ Smart may share some information about users with other users who have sufficient access privileges. The following are ways in which PDQ Smart may share information about you with other users:

- When a User or Owner grants access to a Guest/Visitor, the Guest/Visitor may receive the User's or Owner's name and the address of the Hardware location (which may be PII of the Owner or User). This information allows the Guest/Visitor to identify the location to which the User or Owner is granting access.
- When a Guest/Visitor accesses Hardware, the Hardware's User and Owner may receive information about the Guest/Visitor and the access event, such as the Guest/Visitor's name, an Image of the Guest/Visitor (as collected by the Hardware) and the time of access.
- Users and Owners may also receive aggregate and/or anonymized information about Guest/Visitor's and their Codes, such as frequency of Code generation, frequency and time of Guest/Visitor Code use, and total number of Guest/Visitor's who have accessed a particular Hardware. Owners will also receive information identifying the Hardware and the User controlling such Hardware.
- PDQ Smart may share aggregate, anonymized and/or statistical data about a user's use of the Services. This information may be derived from PII but does not include PII or Images.

Unless expressly stated herein or expressly consented to by you, PDQ Smart does not share your PII with any other users.

Facilitating Transactions: We may use your information in order to facilitate your transactions on the Services (for example, if you purchase any Hardware). In some cases, we employ and contract with people and other entities to perform certain tasks on our behalf and who are under our control (our "Agents"). We may need to share PII with our Agents in order to provide products or services to you. Unless we tell you differently, our Agents do not have any right to use PII or other information we share with them beyond what is necessary to assist us. You hereby consent to our sharing of PII with our Agents.

Business Transfers: In some cases, we may choose to buy or sell assets. In these types of transactions, user information is typically one of the transferred business assets. Additionally, if we, or substantially all of our assets, were acquired, or if we go out of business or enter bankruptcy, user information would be one of the assets that is transferred or acquired by a third party. You acknowledge that such transfers may occur, and that any acquirer of us or our assets may continue to use your PII as set forth in this policy.

pdqSMART Privacy Policy (Cont.)

Our Protection and the Protection of Others: We reserve the right to access, read, preserve, and disclose any information as we reasonably believe is necessary for the following purposes:

- Satisfy any applicable law, rule, regulation, legal process or governmental request
- Enforce this Privacy Policy and the Terms, including investigation of potential violations hereof
- Detect, prevent, or otherwise address fraud, security or technical issues
- Respond to user support requests
- Protect our rights, property or safety, and those of our users and the public

This may include exchanging information with other companies and organizations for fraud protection and spam/malware prevention.

Marketing: We may use your information to send you news about our services, products or promotions. We may also serve advertisements, and also allow third parties to serve advertisements, through the Services. These advertisements are sometimes targeted and served to particular users and may come from third party companies called "ad networks." Ad networks include ad servers, ad agencies, ad technology vendors and research firms.

Advertisements served through the Services may be targeted to users who fit a certain general profile category and may be based on anonymized information inferred from information provided to us by a user (including PII such as gender or age), Services usage patterns of particular users, or a user's activity on Third Party Services.

We do not provide PII to any ad networks for use that is not related to the Services. We will give you the ability to opt out of marketing-related e-mails by logging in and changing your Account settings or by clicking on a link in each such e-mail.

With Your Consent: Except as set forth in this Privacy Policy, you will be notified when your PII may be shared with third parties, and will be able to prevent the sharing of this information.

Information Security:

We seek to protect your Account information to ensure that it is kept private, and we use generally accepted industry-standard techniques to protect the PII submitted to us. However, no method of transmission over the Internet or method of electronic storage is 100% secure. Therefore, we cannot guarantee the absolute security of any information. Unauthorized entry or use, hardware or software failure, and other factors, may compromise the security of user information. It is your responsibility to prevent unauthorized access to your Account and information by selecting and protecting your Account password appropriately, and limiting access to your Devices, including by signing off after you have finished accessing the Services.

Regarding Data Processing:

Your PII may be collected, processed and stored by PDQ Smart or our service providers in the United States and other countries where our servers reside. Please be aware that the privacy protections and legal requirements, including the rights of authorities to access your PII, in some of these countries may not be equivalent to those in your country. If you are using the Services in the European Union or other regions with laws governing data collection and use that may differ from U.S. law, you consent to the transfer of your personal data to the United States and other countries where PDQ Smart and its service providers operates.

Access to Information:

If you are a registered user, you can access information associated with your Account by logging into the Services. Registered and unregistered users can access and delete cookies through their web browser settings. Please note that Guests without an Account cannot access or edit any information.

California Privacy Rights: Under California Civil Code sections 1798.83-1798.84, California residents are entitled to ask us for a notice identifying the categories of personal customer information which we share with our affiliates and/or third parties for marketing purposes, and providing contact information for such affiliates and/or third parties. If you are a California resident and would like a copy of this notice, please submit a written request to the following address: 2754 Creek Hill Road, PA 17540.

Account Deletion:

You can delete your Account by emailing support@PDQSmart.com or using functionality made available through the Apps. After termination, we may retain your information on our servers in accordance with our internal data retention policy.

Choices Regarding Information:

- You can use many of the features of the Services without registering, thereby limiting the type of information that we collect.
- You can always opt not to disclose certain information to us, even though it may be needed to take advantage of some of our features.
- You can delete your Account. Please note that we will need to verify that you have the authority to delete the Account, and activity generated prior to deletion will remain stored by us.
- Registered Account holders can access their Account profiles, payment information and billing history through their Account profile on the Services, and can edit certain information in their Account profiles.

Privacy Policy Changes:

We may amend this Privacy Policy from time to time. If we make changes in the way we collect or use information, we will notify you by posting an announcement on the Services or sending you an email. If you use the Services after changes have been posted, you agree to be bound by the changes.

PDQ Smart Contact Information:

If you have any questions or concerns regarding privacy using the Services, please send us a detailed message to contact@PDQSmart.com, and we will try to resolve your concerns.

pdqSMART Terms of Service

TERMS OF SERVICE

(effective date 11/3/17 rev2)

PDQ Manufacturing, Inc. and its subsidiaries and affiliates (collectively, "PDQ", "PDQ Smart", "we" "us" or "our") provides a smart access system that works for your business, office, warehouse, facility, institution, store, apartment, or home and allows you to grant and monitor access to locations and tools, equipment, cabinets, containers equipped with PDQ Smart components (the "PDQ Smart System"). In connection with the PDQ Smart System, PDQ Smart provides (1) a website accessible at <https://www.pdqlocks.com/about-pdq-smart/> ("Site") and a portal interface <https://portal.pdqlocks.com> ("Portal") (2) services accessible through a user's computer, mobile phone or tablet (each, a "Device" and such services, the "Mobile Apps"); (3) electronic physical access products containing PDQ Smart's proprietary technology ("Hardware"); (4) proprietary software embedded on the Hardware (together with any updates thereto, the "Software") and (5) subscription software services provided in connection with the Software ("Subscription Services"). The Mobile Apps, together with all other applications offered by PDQ Smart in connection with PDQ Smart's services shall be referred to as the "App". The Site, Apps and Subscription Services, and all other features, tools, services and content provided by PDQ Smart in connection with the PDQ Smart System (collectively, the "Services") are intended for use solely with the Hardware or as otherwise made available by PDQ Manufacturing, Inc.

Please read these Terms of Service (collectively with PDQ Smart's Privacy Policy) fully and carefully before using or accessing any of the Hardware or Services. The Terms set forth the legally binding terms and conditions for your use of the Hardware and the Services. If you do not agree with any of the terms set forth herein, you should immediately stop using the Hardware and the Services, including by disconnecting your Hardware and/or unregistering your Devices.

1. Acceptance of Terms:

- a. By clicking "I Agree" on the Site, registering for an Account (defined below) or accessing or using the Services in any manner, including by visiting the Site, or accessing Hardware as a Guest/Visitor (defined below), you agree to these Terms. If you are accessing the Services or Hardware on behalf of an entity, you hereby agree to these Terms on your behalf and on behalf of such entity.
- b. Certain of the Hardware or Services may be subject to additional terms and conditions specified by us from time to time. Your use of such Hardware or Services is subject to those additional terms and conditions. For example, by using any Hardware, you agree to the applicable Limited Warranty and End User License Agreement issued by us in connection with the Hardware. These additional terms, and all other operating rules, policies, and procedures that PDQ Smart may publish from time to time through the Services, are incorporated into the Terms by this reference and, except as expressly set forth in the Terms, may be updated from time to time without notice to you.
- c. **ARBITRATION NOTICE AND CLASS ACTION WAIVER: EXCEPT FOR CERTAIN TYPES OF DISPUTES DESCRIBED IN THE ARBITRATION AND CLASS ACTION WAIVER SECTION BELOW, YOU AGREE THAT DISPUTES BETWEEN YOU AND US WILL BE RESOLVED BY BINDING, INDIVIDUAL ARBITRATION AND YOU WAIVE YOUR RIGHT TO PARTICIPATE IN A CLASS ACTION LAWSUIT OR CLASS-WIDE ARBITRATION.**
- d. If you are accessing and using the Services on behalf of an entity, you represent and warrant that you have the right, authority, and capacity to accept and agree to these Terms on behalf of yourself and the entity you represent.
- e. As described below, you consent to the automatic updating of software included in the Hardware and Services from time to time. If you do not agree, you should not use any software included in the Hardware or Services.

2. Relation of These Terms to Other Agreements: These Terms govern your use of the Services and certain aspects of the Hardware, including data from the Hardware that will be uploaded to the Services. Your use of the Hardware is also covered by (a) the End User Licensing Agreement ("EULA"), which governs the use of the Software and (b) the limited warranty provided with that Hardware ("Limited Warranty"). Certain features of the Services may be subject to additional guidelines, terms, or rules, which will be posted on the Services in connection with such features.

3. Account Types and Access Levels:

- a. **Owners.** The individual who owns Hardware (e.g., a property owner) is the "Owner". If you are an Owner who invites or enables a Manager, Administrator or User to use Hardware you own, you acknowledge and agree that such person may subsequently invite or enable Guest/Visitor's (defined below) to use the Hardware, and therefore access the location equipped with the Hardware. If you are an Owner, you acknowledge and agree that you should only authorize those individuals that you trust to be a Manager, Administrator or User.
- b. **Managers and Administrators.** The individual or entity who manages or administers the facility or site Hardware (e.g., a property manager) is the "Manager" or "Administrator". If you are a Manager or Administrator who invites or enables a User to use Hardware you manage for the Owner, you acknowledge and agree that such User may subsequently invite or enable Guest/Visitor's (defined below) to use the Hardware, and therefore access the location equipped with the Hardware. If you are a Manager or Administrator, you acknowledge and agree that you should only authorize those individuals that you trust to be Users.
- c. **Users.** Individuals who are authorized (usually by the Owner) to control Hardware, such as the employees of companies or tenants of units/spaces equipped with Hardware, are "Users." Users can use the Services to monitor and control the Hardware and access to the location equipped with the Hardware (for example, a User can generate Guest Codes (defined below) or sync his or her Device with the Hardware to obtain access logs).
- d. **Guests and Visitors.** As used in these Terms, a "Guest" or "Visitor" is any person or entity that is given authorization by a User (or in certain limited circumstances, an Owner) through a unique numerical code ("Guest Code") to unlock the User's Hardware. By inviting someone to be a Guest or Visitor, you are giving them the ability to operate your Hardware and therefore access the location with which your Hardware is used. PLEASE BE CAREFUL TO ONLY INVITE TRUSTED GUESTS OR VISITORS. Guest or Visitor information, including video and/or photographic images of Guests and Visitors who access Hardware (collectively, "Images"), may be (i) received by PDQ Smart; (ii) shared with such Hardware's User and Owner and (iii) use and shared as described in our Privacy Policy; provided that Images will only be received by PDQ Smart and shared with a Hardware's User and Owner. More information about the sharing of Guest information can also be found in Section 11(c) below. If you are a Guest or have been invited to access Hardware as a Guest but do not want your information to be further used or shared, do not use the Guest Code or otherwise access the Hardware or Services in any manner.

A User or Owner may revoke or limit access rights in their discretion without notice to the Guest or Visitor.

WHETHER YOU ARE A USER, OWNER, MANAGER OR ADMINISTRATOR YOU SHOULD ONLY AUTHORIZE GUESTS AND VISITORS THAT YOU ARE CERTAIN YOU WOULD LIKE TO GRANT ACCESS TO, IN EACH CASE, AFTER CAREFUL REVIEW AND DILIGENCE. YOU ARE RESPONSIBLE FOR ALL OF YOUR ACTIONS IN CONNECTION WITH THE HARDWARE AND SERVICES AS WELL AS ALL ACTIONS CONDUCTED THROUGH YOUR ACCOUNT(S), WHETHER OR NOT AUTHORIZED BY YOU.

- e. **Multiple Account Levels.** One individual may have multiple Accounts or user types with respect to a single piece of Hardware. For example, an Owner may also be a User of certain Hardware until another individual occupies a space, or unit equipped with such Hardware, and therefore would be able to use his or her User Account to generate Guest Codes for such Hardware beyond the limited circumstances applicable to an Owner Account.

4. Eligibility:

- a. In order to register for any account on the Services ("Account"), you must be at least 18 years old. If you are under 18 years old but over 13 years old, you may be registered for a User Account or Guest Account and use the Services as a User or Guest, respectively, only under the supervision of a parent or legal guardian who agrees to be bound by these Terms. If you are under 13 years old, you may not use any part of the Services, under any circumstances or for any reason, either as a registered or unregistered user.
- b. You will be bound by these Terms wherever you access or use the Hardware or Services. Although our Site is accessible worldwide, the Hardware and Services are not available to all persons or in all countries. To the extent permissible by law, PDQ Smart accepts no responsibility or liability for any damage or loss caused by your accessing or use of the Services or Hardware in a country not specifically approved by PDQ Smart. You are solely responsible for ensuring that these Terms are in compliance with all laws, rules and regulations applicable to you, including but not limited to (i) any laws relating to the recording or sharing of image or video content that includes third parties or (ii) any laws requiring notice to or consent of third parties with respect to your use of PDQ Smart's Services and Hardware. The right to access the Hardware and Services is revoked where these Terms or use of the Hardware and Services is prohibited or to the extent offering, sale or provision of the Hardware or Services conflicts with any applicable law, rule or regulation.

pdqSMART Terms of Service (Cont.)

- c. By using the Services, you represent and warrant that you meet all the eligibility requirements set forth in these Terms. We may, in our sole discretion, refuse to offer the Services to any person or entity and change its eligibility criteria at any time.
- d. The Services are offered only for your use, and not for the use or benefit of any third party.
5. Registration: To sign up for the Services, you must register for an Account. Please note that signing up for the Services is different from accessing the Hardware, as you can access the Hardware as a Guest without signing up for an Account. When signing up for an Account, you must provide accurate and complete information and keep your Account information updated. You shall have the ability to delete your Account, either directly or through a request made to one of our employees or affiliates at support@PDQSmart.com, but please note that some of the Services may not be available to you if you delete your Account. You grant us the right to use the information provided by you through the registration process, and any other information you provide to us through your use of the Services, in connection with the operation of the Services or as set forth in our Privacy Policy.
6. Account Security:
- a. You must keep your Account and any password, pin code or Device you use in connection with the Hardware or Services secure. You agree to use strong passwords and pin codes, and to maintain the confidentiality of your password and all pin codes. You may never use another person's user Account or registration information for the Services without permission. You shall be responsible for all uses of your Account, Device and login information, whether or not authorized by you. PDQ Smart shall not be responsible for any actions or omissions of any individual to whom access is granted through your Account, regardless of whether you intended to grant such individual access. You must notify us immediately of any change in your eligibility to use the Services, breach of security or unauthorized use of your Account, Device or any passwords or pin codes, and you should immediately change your password or pin code, as applicable, to prevent further unauthorized use. You should never publish, distribute or post login information for your Account. PDQ Smart is not liable for any loss or damage arising from your failure to comply with the above requirements. Guest Codes are only for the use of the individual to whom such Guest Code was issued. You must not share or disclose your Guest Code with or to any other individual at any time.
- b. We strongly recommend that you do not use the Services on a Device with a "jail broken" or "rooted" operating system. These operating systems can potentially allow other applications to circumvent security features on your Device. Any use of such Devices is at your own risk. You agree that PDQ Smart will not be liable for any loss of functionality caused by such use and will indemnify us for all damage or liability arising or resulting therefrom.
7. Services:
- a. The Services are designed to be used in connection with the Hardware, such as a PDQ smart electronic lock, camera's, recording devices and other sensor devices.
- b. Subject to these Terms, we grant you a non-transferable, non-exclusive, right (without the right to sublicense) to access and use the Services by (i) using the Site or Apps, solely in connection with the Hardware that is either installed on your property, that you have been validly authorized to access, or that is otherwise expressly provided by PDQ Smart for your use and (ii) installing and using the Apps on your Device(s), solely for the purpose of using the Hardware and the Services in accordance with these Terms. You agree to comply with all instructions, usage rules and documentation that we may provide from time to time with respect to the Service or Hardware.
- c. Please note that we may from time to time update the Services, including without limitation by providing improvements, updates, new functionality, bug fixes, or other modifications (collectively "Updates"). These Updates may occur automatically, without notice or any request for additional consent. By using the Services, you hereby consent to the Updates. If you do not want to receive the Updates, you must terminate your Account and stop using the Services, including the Software. In the event that we ask you to install Updates, you agree to do so promptly. We are not liable for any failure to install the Updates or any damages resulting therefrom. Updates are subject to these Terms, as well as any terms that apply to the Software and any additional terms that may be provided with such Update. By continuing to use the Services, you agree to all terms applicable to the Updates, including the EULA for the relevant Software.
8. System Requirements:
- a. In order to take advantage of full functionality associated with the Hardware and Services, the following are necessary: (i) properly functioning Hardware (including sufficient battery power, if applicable); (ii) at least one Device equipped with the Mobile App and a working Bluetooth connection; (iii) at least one valid User Account and (iv) other system elements that may be specified by PDQ Smart from time to time.
- b. You acknowledge that the availability of the Services is dependent on (i) your computer, mobile device, wiring, Wi-Fi network, Bluetooth connection, and other related equipment; (ii) your Internet service provider ("ISP"); and (iii) your mobile device carrier ("Mobile Carrier"). You acknowledge that you are responsible for all fees charged by your ISP and Mobile Carrier in connection with your use of the Services. You also acknowledge that you are responsible for compliance with all applicable agreements, terms of use or terms of service, and other policies of your ISP and Mobile Carrier. It is your responsibility to ensure that you have all required system elements and that they are compatible, up-to-date, and properly configured. You acknowledge that the Services may not work as described when the requirements and compatibility have not been met.
9. Open Source: The Services may contain or be distributed with open source software which may be covered by a different license. You agree that all open source software shall be and shall remain subject to the terms and conditions under which it is provided, and you shall be responsible for compliance with such terms.
10. Feedback: You acknowledge that any suggestions, ideas, comments or other feedback you provide to us regarding the Hardware or Services ("Feedback") shall become our sole and exclusive property without any compensation to you. We may, in our sole discretion, decide whether to use the Feedback in any of our products and services. You hereby assign to us all of your right, title and interest in the Feedback, including but not limited to all copyrights, patent rights, trade secrets and trademarks.
11. Content:
- a. Definition. For purposes of these Terms, the term "Content" includes, without limitation, information, data, text, photographs (including Images), videos, audio clips, written posts and comments, software, scripts, graphics, and interactive features generated, provided, or otherwise made accessible on or through the Services. For the purposes of this Agreement, "Content" also includes all User Content (as defined below).
- b. User Content. All Content added, created, uploaded, submitted, distributed, or posted to the Services by users (collectively "User Content") is the sole responsibility of the person who originated such User Content. You acknowledge that all Content, including User Content, accessed by you using the Services is at your own risk and you will be solely responsible for any damage or loss to you or any other party resulting therefrom. We do not guarantee that any Content you access on or through the Services is or will continue to be accurate. You represent that (i) all User Content provided by you is accurate, complete, up-to-date, and in compliance with all applicable laws, rules and regulations and (ii) you have all rights necessary to upload, post, email, transmit, or otherwise disseminate your User Content using, or in connection with, the Services, or that you contribute in any manner to the Services, in the manner in which you contribute, without infringement or violation of any third party rights, including without limitation, any privacy rights, publicity rights, copyrights, trademarks, contract rights, or any other intellectual property or proprietary rights.
- c. Use and Sharing of User Content and Content about users:
- i. By submitting User Content through the Services, you hereby do and shall grant us a worldwide, non-exclusive, perpetual, royalty-free, fully paid, sublicensable and transferable license to use, edit, modify, truncate, aggregate, reproduce, distribute, prepare derivative works of, display, perform, and otherwise fully exploit the User Content in connection with the Services and our (and our successors' and assigns') businesses, including after the termination of your Account or the Services.
- ii. User Content is used to provide, operate, maintain and improve the Hardware and Services. Some information and content provided by or about users (including Owners, Managers, Administrators, Users, Guests and Visitors), may be visible to others users who have sufficient access privileges. In particular, the following are a few ways users may receive information about other users. By using the Services in any manner, including as a Guest, you are consenting to the sharing of your information as set forth herein and in the Privacy Policy.

pdqSMART Terms of Service (Cont.)

- When an Owner, Manager, Administrator or User grants access to a Guest or Visitor, the Guest/Visitor may receive the User's or Owner's name and the address of the Hardware location. This information allows the Guest or Visitor to identify the location to which the User or Owner is granting access.
 - When a Guest or Visitor accesses Hardware, the Hardware's Owner, Manager, Administrator or User may receive information about the Guest or Visitor and the access event, such as the Guest's or Visitors name, an Image of the Guest or Visitor (as collected by the Hardware) and the time of access.
 - Owner's, Manager's, Administrator's or User's may also receive aggregate and/or anonymized information about Guests or Visitors and Guest Codes, such as frequency of Guest Code generation, frequency and time of Guest Code use, and total number of Guests or Visitors who have accessed a particular Hardware. Owners will also receive information identifying the Hardware and the User controlling such Hardware.
- d. Notices and Restrictions: The Services may contain Content specifically provided by us, our partners or our users, and such Content is protected by copyrights, trademarks, service marks, patents, trade secrets or other proprietary rights and laws. You shall abide by and maintain all copyright notices, information, and restrictions contained in any Content accessed through the Services.
- e. Availability of Content: We reserve the right, but do not have any obligation to remove, block, edit or modify any Content at our sole discretion, at any time, without notice to you and for any reason or for no reason at all. We do not guarantee that any Content will be made available through the Services.
12. SMS, MMS and Other Text Messaging: As part of the Services, we may communicate with users by sending SMS, MMS or other text messages ("Text Messages"). For example, Guest Codes may be sent to Guests or Visitors, and notifications may be sent to Users, via Text Message. Please note that text messaging fees may apply to the sending or receipt of Text Messages. By registering for an Account, you hereby consent to receiving Text Messages from us to your Device. You may opt out of receiving such messages in the future, but the Services may not work properly if you do opt out. If you are a Owner, Manager, Administrator, or User you are responsible for obtaining the consent of your Guests to receive Text Messages from you in connection with the Services. By sending a Guest Code to a Guest or Visitor, you represent and warrant that you have all necessary consent from such Guest or visitor to the receipt of Text Messages, including to any fees associated therewith.
13. Rules of Conduct:
- a. The Hardware and Services, and any Content made available through or in connection with the Hardware and Services, including any and all Images, are solely intended for monitoring and controlling access to the location on which the Hardware is installed. As a condition of use, you promise to use the Hardware and Services only for the purposes set forth in these Terms. You may not use the Hardware or Services for any purpose that is unlawful, threatening, abusive, harassing, defamatory, libelous, deceptive, fraudulent, invasive of another's privacy, tortious, or is otherwise inappropriate, as determined by us in our sole discretion. You are responsible for all of your activity in connection with the Hardware and Services.
- b. You shall not (and shall not permit any third party to) either (i) take any action or (ii) provide any Content that: (A) you know is false, misleading, untruthful or inaccurate or (B) contains software viruses or any other computer codes, files, or programs that are designed or intended to disrupt, damage, limit or interfere with the proper function of any software, hardware, or telecommunications equipment or to damage or obtain unauthorized access to any system, data, password or other information of ours or of any third party.
- c. You must not jeopardize the security of your Account or anyone else's Account, including by allowing someone else to log in to the Services as you or sharing a Guest Code with any other party.
- d. You shall not: (i) take any action that imposes or may impose (as determined by us in our sole discretion) an unreasonable or disproportionately large load on our (or our third party providers') infrastructure; (ii) interfere or attempt to interfere with the proper working of the Services or any activities conducted on the Services; (iii) bypass, circumvent or attempt to bypass or circumvent any measures we may use to prevent or restrict access to the Services (or other accounts, computer systems or networks connected to the Services); (iv) run any form of auto-responder or "spam" on the Services; (v) use manual or automated software, devices, or other processes to "crawl" or "spider" any page of the Site or Services; (vi) harvest or scrape any Content from the Services; or (vii) otherwise take any action in violation of our guidelines and policies.
- e. You shall not (directly or indirectly): (i) decipher, decompile, disassemble, reverse engineer or otherwise attempt to derive any source code or underlying ideas or algorithms of any part of the Services (including without limitation any application), except to the limited extent applicable laws specifically prohibit such restriction; (ii) modify, translate, or otherwise create derivative works of any part of the Services or (iii) resell, copy, rent, lease, distribute, or otherwise transfer any of the rights that you receive hereunder. You shall abide by all applicable local, state, national and international laws and regulations. Any future release, update, or other addition to functionality of the Services shall be subject to these Terms.
- f. You may only copy or download parts of the Services (including any Content, any part of the Site or Apps, any Guest information and any images collected and/or provided in connection with the Services, including Guests' Images) onto your own Device for your own use, and solely as necessary to use the Services as contemplated hereunder. You may not use the content of the Services, including any Images, in any other way or for any other purpose, including without limitation any public or commercial way, nor may you copy or incorporate any of the content of the Services into any other work, without the written consent of PDQ Smart. You must have PDQ Smart's prior written consent before you can post or redistribute any portion of the Services.
- g. Other than with respect to User Content, as between you and us, we retain full and complete title to all Content on the Services, including any downloadable software and all data that accompanies it. You may not copy, modify or in any way reproduce or damage the structure or presentation of the Services or any Content therein.
- h. We reserve the right to access, read, preserve, and disclose any information as we reasonably believe is necessary to (i) satisfy any applicable law, regulation, legal process or governmental request; (ii) enforce these Terms, including investigation of potential violations hereof; (iii) detect, prevent, or otherwise address fraud, security or technical issues; (iv) respond to user support requests or (v) protect the rights, property or safety of us, our users and the public.
14. Acts of Users: PDQ Smart is not responsible for the acts, omissions or behavior of any person or entity who is able to access the Hardware or Services through your Account or otherwise receives access from you (whether directly or indirectly), or for any personal injury, death, property damage (including, without limitation, to your home), or other harm or losses arising from or relating to your or their use of the Hardware or Services.
15. Third Party Services:
- a. The Services may be used in connection with other products and services, and may contain links, interfaces and referrals to, as well as content and data from, third-party websites, products and services. When you access third party resources, you do so at your own risk. These other resources are not under our control, and you acknowledge that we are not responsible or liable for the content, functions, accuracy, legality, appropriateness or any other aspect of such websites or resources. The inclusion of any third party services does not imply our endorsement or any association between us and their operators. You further acknowledge and agree that we shall not be responsible or liable, directly or indirectly, for any damage or loss caused or alleged to be caused by or in connection with the use of or reliance on any such content, goods or services available on or through any such website or resource.
- b. By accessing or using these third party services, you are consenting to the exchange of information and data between PDQ Smart and the applicable third party service providers regarding you, your Guests and your use of the Services, including your and your Guests' personal information, in order to enable the third party service's functionality and services as requested by you. Once this information is shared with the third party service provider, its use will be governed by the third party's privacy policy (and not by our Privacy Policy) and terms of use. You should review the terms of use and privacy policies of any third party service before using the applicable service. You acknowledge and agree that we make no representation or warranty about the safety of any third party services and are not responsible for your use of any third party services or any personal injury, death, property damage (including, without limitation, to your home), or other harm or losses arising from or relating to your use thereof.
16. Information Received Through the Services: Any information you receive through or about the Services or the Hardware is provided "as is" and "as available". We cannot guarantee that any information is correct or up to date. Information provided through the Services is not a substitute for information from experts or professionals in the applicable area.

pdqSMART Terms of Service (Cont.)

17. App Store: You acknowledge and agree that the availability of the Mobile Apps is dependent on the third party websites from which you download the Mobile Apps, e.g., the App Store from Apple or the Android app market from Google (each an "App Store"). Each App Store may have its own terms and conditions to which you must agree before downloading Mobile Apps from such store, including the Apple, Inc. Device and Service Terms for the Apple App Store set forth below. You agree to comply with, and your license to use the Mobile Apps is conditioned upon your compliance with, such App Store terms and conditions. To the extent such other terms and conditions from such App Store are less restrictive than, or otherwise conflict with, the terms and conditions of these Terms, the more restrictive or conflicting terms and conditions in these Terms apply.

a. Apple, Inc. Device and Service Terms: If you are accessing the Services on a device provided by Apple, Inc. ("Apple") or otherwise obtained access to the Services through the Apple App Store, the following terms shall apply:

1. Both you and we acknowledge that these Terms are concluded between you and us only, and not with Apple, and that Apple is not responsible for, does not endorse, and is not involved in the Services or Content;
2. The Services are licensed to you on a limited, non-exclusive, non-transferrable, non-sublicensable basis, solely to be used in connection with the Services for your private, personal, non-commercial use, subject to all the terms and conditions of these Terms as applicable;
3. You will only use the Services in connection with an Apple device that you own or control;
4. You acknowledge and agree that Apple has no obligation whatsoever to furnish any maintenance and support services with respect to the Services;
5. In the event of any failure of the Services to conform to any applicable warranty, including those implied by law, you may notify Apple of such failure; upon notification, Apple's sole warranty obligation to you will be to refund to you the purchase price, if any, of the Services;
6. You acknowledge and agree that we, and not Apple, are responsible for addressing any claims you or any third party may have in relation to our Services;
7. You acknowledge and agree that, in the event of any third party claim that the Services or your possession and use of the Services infringes that third party's intellectual property rights, we, and not Apple, will be responsible for the investigation, defense, settlement and discharge of any such infringement claim;
8. You represent and warrant that you are not located in a country subject to a U.S. Government embargo, or that has been designated by the U.S. Government as a "terrorist supporting" country, and that you are not listed on any U.S. Government list of prohibited or restricted parties;
9. Both you and we acknowledge and agree that, in your use of the Services, you will comply with any applicable third party terms of agreement which may affect or be affected by such use; and
10. Both you and we acknowledge and agree that Apple and Apple's subsidiaries are third party beneficiaries of these Terms, and that upon your acceptance of these Terms, Apple will have the right (and will be deemed to have accepted the right) to enforce these Terms against you as the third party beneficiary hereof.

b. You acknowledge that these Terms are between you and PDQ Smart and not with an App Store.

18. Modification; Suspension; Termination:

- a. We may change or remove any features currently offered as part of the Services, or the Services themselves, at any time.
- b. The Services may be suspended temporarily without notice for security reasons, system failure, maintenance, repair, or other circumstances. You agree that you will not be entitled to any refund or rebate in connection with any such suspensions.
- c. We may terminate your access to all or any part of the Services at any time, with or without cause, with or without notice, effective immediately, which may result in the forfeiture and destruction of all information associated with your Account. If you wish to terminate your Account, you may do so by following instructions posted on the Site or made available through the Services, or by emailing us at support@PDQSmart.com. Upon termination, your Account and right to use the Software and other Services will automatically terminate, but you may be able to continue using some parts of the Hardware. Any fees paid hereunder are non-refundable. All provisions of these Terms which by their nature should survive termination shall survive termination, including, without limitation, licenses of User Content, ownership provisions, warranty disclaimers, indemnity and limitations of liability.
- d. If you transfer your Hardware to a new Owner or User, your right to use the Services with respect to the transferred Hardware automatically terminates. Your Account is not transferable, and the new Owner or User will have to register for a separate Account in order to use the Services.

19. Limitations:

- a. Our aim is to make the Services highly reliable and consistently available; however, we cannot and do not guarantee that the Services will be available all of the time. The Services may be subject to sporadic interruptions and failures for a variety of reasons beyond PDQ Smart's control, including without limitation, third party network failures and coverage limitations, service provider uptime, and acts of God. Furthermore, our Services rely on or interoperate with a number of third party products and services. These third party products and services are beyond our control and their operation or failure may impact the use and reliability of our Services. PDQ Smart is not responsible for damages and losses due to these third party products and services. You acknowledge these limitations and agree that PDQ Smart is not responsible for any damages allegedly caused by the failure or delay of the Services.
- b. To the fullest extent allowed by law, PDQ Smart is not responsible for damage or liability caused by (i) use of the Hardware and Services for purposes other than for which the Hardware and Services are designed or intended, or in improper conditions or in violation of written instructions provided by PDQ Smart; (ii) normal wear and tear or aging; (iii) improper repair, operation, maintenance or connections or (iv) to the extent allowed by law, attempted repair by anyone other than a facility authorized by PDQ Smart.
- c. The Hardware is not an ANSI or BHMA certified door lock and must be correctly installed and kept in good condition. You assume all risk associated with the suitability, installation and performance of the Hardware and other third party components, hardware, software and services.

20. Warranty Disclaimer:

- a. THE WARRANTIES FOR THE HARDWARE AND SOFTWARE ARE SET FORTH IN THE LIMITED WARRANTY AND THE END USER LICENSE AGREEMENT, RESPECTIVELY.
- b. THE SERVICES ARE PROVIDED FOR YOUR CONVENIENCE, "AS IS" AND "AS AVAILABLE" AND PDQ SMART AND ITS AFFILIATES, LICENSORS AND SUPPLIERS EXPRESSLY DISCLAIM ANY WARRANTIES AND CONDITIONS OF ANY KIND, WHETHER EXPRESS OR IMPLIED, INCLUDING THE WARRANTIES OR CONDITIONS OF MERCHANTABILITY, FITNESS FOR A PARTICULAR PURPOSE, ACCURACY, AND NON-INFRINGEMENT. PDQ SMART AND OUR LICENSORS AND SUPPLIERS MAKE NO WARRANTY THAT DEFECTS WILL BE CORRECTED OR THAT THE SERVICES: (I) WILL MEET YOUR REQUIREMENTS; (II) WILL BE COMPATIBLE WITH YOUR BUSINESS OR HOME NETWORK, COMPUTER OR DEVICE; (III) WILL BE AVAILABLE ON AN UNINTERRUPTED, TIMELY, SECURE, OR ERROR-FREE BASIS; OR (IV) WILL BE ACCURATE OR RELIABLE. NO ADVICE OR INFORMATION, WHETHER ORAL OR WRITTEN, OBTAINED BY YOU FROM PDQ SMART OR THROUGH THE SERVICES SHALL CREATE ANY WARRANTY.

pdqSMART Terms of Service (Cont.)

- c. WHEN YOU INVITE GUESTS OR SERVICE PROVIDERS TO USE YOUR DEVICE, HARDWARE OR THE SERVICE, YOU ASSUME ALL RESPONSIBILITY FOR THEIR USE, AND ANY DAMAGES THAT THEY MAY CAUSE TO YOU, PDQ SMART, ANY THIRD PARTY OR ANY OF EACH OF OUR OR THEIR PROPERTY. YOU MUST CHOOSE YOUR INVITED GUESTS AND SERVICE PROVIDERS CAREFULLY. PDQ SMART DOES NOT WARRANT, ENDORSE, GUARANTEE, OR ASSUME RESPONSIBILITY FOR ANY PRODUCT OR SERVICE ADVERTISED OR OFFERED BY A THIRD PARTY THROUGH OR IN CONNECTION WITH THE HARDWARE OR SERVICES (INCLUDING, BUT NOT LIMITED TO, THIRD PARTY PRODUCTS AND SERVICES CONNECTED WITH OR TO THE HARDWARE OR SERVICES) OR ANY HYPERLINKED WEBSITE OR SERVICE, AND PDQ SMART WILL NOT BE A PARTY TO OR IN ANY WAY MONITOR ANY TRANSACTION BETWEEN YOU AND THIRD-PARTY PROVIDERS OF SUCH PRODUCTS OR SERVICES.
- d. You release us from all liability arising from or related to (i) your inability to acquire Content through the Services or (ii) any Content you acquire through the Services. We make no representations concerning any Content contained in or accessed through the Services, and we will not be responsible or liable for the accuracy, copyright compliance, or legality of material or Content contained in or accessed through the Services.
- e. You shall and hereby do waive California Civil Code Section 1542 or any other similar law of any jurisdiction, which says in substance: "A general release does not extend to claims which the creditor does not know or suspect to exist in his favor at the time of executing the release, which, if known by him must have materially affected his settlement with the debtor."
21. Indemnification: You shall defend, indemnify, and hold harmless us, our affiliates and each of our and their respective employees, contractors, directors, suppliers and representatives from all liabilities, claims, and expenses, including reasonable attorneys' fees, that arise from or relate to your, your Guests' or any third party's (a) use or misuse of, or access to, the Hardware, Services or Content; (b) violation of law, third party right or the Terms or (c) violation or infringement of any intellectual property or other right of any person or entity. We reserve the right to assume the exclusive defense and control of any matter otherwise subject to indemnification by you, in which event you will assist and cooperate with us in asserting any available defenses.
22. Limitation of Liability: IN NO EVENT SHALL WE, NOR OUR DIRECTORS, EMPLOYEES, AGENTS, PARTNERS, SUPPLIERS OR CONTENT PROVIDERS, BE LIABLE UNDER CONTRACT, TORT, STRICT LIABILITY, NEGLIGENCE OR ANY OTHER LEGAL OR EQUITABLE THEORY WITH RESPECT TO THE HARDWARE OR SERVICES FOR (A) ANY LOST PROFITS, DATA LOSS, COST OF PROCUREMENT OF SUBSTITUTE GOODS OR SERVICES, OR SPECIAL, INDIRECT, INCIDENTAL, PUNITIVE, COMPENSATORY OR CONSEQUENTIAL DAMAGES OF ANY KIND WHATSOEVER (HOWEVER ARISING); (B) ANY BUGS, VIRUSES, TROJAN HORSES, OR THE LIKE (REGARDLESS OF THE SOURCE OF ORIGIN) OR (C) ANY DIRECT DAMAGES IN EXCESS OF (IN THE AGGREGATE) OF THE GREATER OF (I) FEES ACTUALLY PAID TO US FOR THE PARTICULAR HARDWARE OR SERVICES DURING THE IMMEDIATELY PREVIOUS TWELVE (12) MONTH PERIOD OR (II) \$100.00. SOME STATES DO NOT ALLOW THE TYPES OF LIMITATIONS IN THIS PARAGRAPH, SO THEY MAY NOT APPLY TO YOU. NOTHING IN THESE TERMS OR THIS "LIMITATION OF LIABILITY" CLAUSE SHALL ATTEMPT TO EXCLUDE LIABILITY THAT CANNOT BE EXCLUDED UNDER APPLICABLE LAW.
23. ARBITRATION AND CLASS ACTION WAIVER – IMPORTANT – PLEASE REVIEW AS THIS AFFECTS YOUR LEGAL RIGHTS:
- a. ARBITRATION. YOU AGREE THAT ALL DISPUTES BETWEEN YOU AND US (WHETHER OR NOT SUCH DISPUTE INVOLVES A THIRD PARTY) WITH REGARD TO YOUR RELATIONSHIP WITH US, INCLUDING WITHOUT LIMITATION DISPUTES RELATED TO THESE TERMS OF SERVICE, YOUR USE OF THE SERVICES, AND/OR RIGHTS OF PRIVACY AND/OR PUBLICITY, WILL BE RESOLVED BY BINDING, INDIVIDUAL ARBITRATION IN ACCORDANCE WITH THE STREAMLINED ARBITRATION RULES AND PROCEDURES OF THE JAMS ALTERNATE DISPUTE RESOLUTION GROUP THEN IN EFFECT, AND YOU AND WE HEREBY EXPRESSLY WAIVE TRIAL BY JURY; PROVIDED, HOWEVER, THAT TO THE EXTENT THAT YOU HAVE IN ANY MANNER VIOLATED OR THREATENED TO VIOLATE OUR INTELLECTUAL PROPERTY RIGHTS, WE MAY SEEK INJUNCTIVE OR OTHER APPROPRIATE RELIEF IN ANY STATE OR FEDERAL COURT IN THE STATE OF PENNSYLVANIA. DISCOVERY AND RIGHTS TO APPEAL IN ARBITRATION ARE GENERALLY MORE LIMITED THAN IN A LAWSUIT, AND OTHER RIGHTS THAT YOU AND WE WOULD HAVE IN COURT MAY NOT BE AVAILABLE IN ARBITRATION. AS AN ALTERNATIVE, YOU MAY BRING YOUR CLAIM IN YOUR LOCAL "SMALL CLAIMS" COURT, IF PERMITTED BY THAT SMALL CLAIMS COURT'S RULES AND IF WITHIN SUCH COURT'S JURISDICTION, UNLESS SUCH ACTION IS TRANSFERRED, REMOVED OR APPEALED TO A DIFFERENT COURT. YOU MAY BRING CLAIMS ONLY ON YOUR OWN BEHALF. NEITHER YOU NOR WE WILL PARTICIPATE IN A CLASS ACTION OR CLASS-WIDE ARBITRATION FOR ANY CLAIMS COVERED BY THIS AGREEMENT TO ARBITRATE. YOU ARE GIVING UP YOUR RIGHT TO PARTICIPATE AS A CLASS REPRESENTATIVE OR CLASS MEMBER ON ANY CLASS CLAIM YOU MAY HAVE AGAINST US INCLUDING ANY RIGHT TO CLASS ARBITRATION OR ANY CONSOLIDATION OF INDIVIDUAL ARBITRATIONS. You also agree not to participate in claims brought in a private attorney general or representative capacity, or consolidated claims involving another person's account, if we are a party to the proceeding. This dispute resolution provision will be governed by the Federal Arbitration Act and not by any state law concerning arbitration. Judgment on the award rendered by the arbitrator may be entered in any court having competent jurisdiction. Any provision of applicable law notwithstanding, the arbitrator will not have authority to award damages, remedies or awards that conflict with these Terms. You agree that regardless of any statute or law to the contrary, any claim or cause of action arising out of, related to or connected with the use of the Hardware or Services or these Terms must be filed within one (1) year after such claim of action arose or be forever banned.
- b. 30-Day Opt-Out Period. If you do not wish to be bound by the arbitration and class-action waiver provisions in this Section 23, you must notify PDQ Smart in writing within 30 days of the date that you first accept these Terms (unless a longer period is required by applicable law). Your written notification must be mailed to PDQ Smart at the following address: PDQ Smart 2754 Creek Hill Road, PA 17540. If you do not notify PDQ Smart in accordance with this Section 23(b), you agree to be bound by the arbitration and class-action waiver provisions of these Terms, including such provisions in any Terms revised after the date of your first acceptance. Such notification must include: (i) your name, (ii) your PDQ Smart Account number or user name; (c) your mailing address and (d) a statement that you do not wish to resolve disputes with PDQ Smart through arbitration. If PDQ Smart makes any changes to the Arbitration and Class Action Waiver section of these Terms (other than a change to the address at which PDQ Smart will receive notices of dispute, opt-out notices, or rejections of future changes to the Arbitration and Class Action Waiver section), you may reject any such change by sending us written notice within 30 days of the change to the address set forth in this Section 23(b). It is not necessary to send us a rejection of a future change to the Arbitration and Class Action Waiver section of these Terms if you had properly opted out of the arbitration and class-action waiver provisions in this Section 23 within the first 30 days after you first accepted these Terms. If you have not properly opted out of the arbitration and class-action waiver provisions in this Section 23, by rejecting a future change, you are agreeing that you will arbitrate any dispute between us in accordance with the language of this arbitration provision, as modified by any changes you did not reject. This notification affects these Terms only; if you previously entered into other arbitration agreements with PDQ Smart or enter into other such agreements in the future, your notification that you are opting out of the arbitration provision in these Terms shall not affect the other arbitration agreements between you and PDQ Smart.
- c. Severability. If the prohibition against class actions and other claims brought on behalf of third parties contained above is found to be unenforceable, then all of the preceding language in this Arbitration and Class Action Waiver section will be null and void. This arbitration agreement will survive the termination of your relationship with us.
24. Governing Law and Jurisdiction: These Terms shall be governed by and construed in accordance with the laws of the State of Pennsylvania, including its conflicts of law rules, and the United States of America. You agree that any dispute arising from or relating to the subject matter of these Terms shall be governed by the exclusive jurisdiction and venue of the state and Federal courts of Lancaster County, Pennsylvania.
25. Modification:
- a. We reserve the right, in our sole discretion, to modify or replace any of these Terms, or change, suspend, or discontinue the Services (including without limitation, the availability of any feature or Content) at any time by posting a notice on the Site or by sending you notice through the Services, via e-mail or by another appropriate means of electronic communication. While we will timely provide notice of modifications, it is also your responsibility to check these Terms periodically for changes. Your continued use of the Services following notification of any changes to these Terms constitutes acceptance of those changes, which will apply to your continued use of the Services going forward. Your use of the Services is subject to the Terms in effect at the time of such use.
- b. Our employees are not authorized to vary these Terms. These Terms may be modified only (i) by obtaining our written consent in an agreement signed by an officer of PDQ Smart; or (ii) as set forth above in the immediately preceding paragraph.

pdqSMART Terms of Service (Cont.)

26. Miscellaneous:

- a. **Entire Agreement and Severability:** These Terms and any other applicable documentation made available to you by PDQ Smart are the entire agreement between you and us with respect to the Services and supersede all prior or contemporaneous communications and proposals (whether oral, written or electronic) between you and us with respect to the Services. If any provision of these Terms is found to be unenforceable or invalid, that provision will be limited or eliminated to the minimum extent necessary so that these Terms will otherwise remain in full force and effect and enforceable. The failure of either party to exercise in any respect any right provided for herein shall not be deemed a waiver of any further rights hereunder.
- b. **Force Majeure.** We shall not be liable for any failure to perform our obligations hereunder where such failure results from any cause beyond our reasonable control, including, without limitation, mechanical, electronic or communications failure or degradation.
- c. **Assignment.** These Terms are personal to you, and are not assignable, transferable or sublicensable by you except with our prior written consent. We may assign, transfer or delegate any of our rights and obligations hereunder without consent.
- d. **Agency.** No agency, partnership, joint venture, or employment relationship is created as a result of these Terms and neither party has any authority of any kind to bind the other in any respect.
- e. **Notices.** Unless otherwise specified in these Terms, all notices under these Terms will be in writing and will be deemed to have been duly given when received, if personally delivered or sent by certified or registered mail, return receipt requested; when receipt is electronically confirmed, if transmitted by facsimile or e-mail; or the day after it is sent, if sent for next day delivery by recognized overnight delivery service. Electronic notices should be sent to support@PDQSmart.com.
- f. **No Waiver.** Our failure to enforce any part of these Terms shall not constitute a waiver of our right to later enforce that or any other part of these Terms. Waiver of compliance in any particular instance does not mean that we will waive compliance in the future. In order for any waiver of compliance with these Terms to be binding, we must provide you with written notice of such waiver through one of our authorized representatives.
- g. **Headings; Interpretation.** The section and paragraph headings in these Terms are for convenience only and shall not affect their interpretation. Any use of "including" "for example" or "such as" in these Terms shall be read as being followed by "without limitation" where appropriate.

pdqSMART Warranty

LIMITED WARRANTY

(effective date 11/4/17 rev3)

This PDQ Smart Hardware Limited Warranty ("Warranty") sets forth the warranty terms applicable to your PDQ Manufacturing, Inc. ("PDQ Smart") electronic physical access control product ("Hardware"). Please read this Warranty before using the Hardware.

THIS WARRANTY CONTAINS IMPORTANT INFORMATION ABOUT YOUR RIGHTS AND OBLIGATIONS, AS WELL AS LIMITATIONS AND EXCLUSIONS THAT MAY APPLY TO YOU. BY USING THE HARDWARE IN ANY WAY, YOU ARE AGREEING TO BE BOUND BY THE TERMS OF THIS LIMITED WARRANTY SET FORTH BELOW. IF YOU DO NOT AGREE TO THE TERMS OF THIS WARRANTY, DO NOT USE THE HARDWARE..

Limited Warranty.

PDQ Manufacturing warrants to the owner of the Hardware that the Hardware, when used normally and in accordance with PDQ Smart's technical specifications and user instructions, will be substantially free from defects in materials and workmanship for a period of 2 year from the date of purchase (the "Warranty Period"). If Hardware is returned to PDQ during the Warranty Period in accordance with the terms and conditions of this Warranty, and PDQ determines that the Hardware is defective, PDQ will either (i) repair the Hardware; (ii) replace the returned Hardware with either a new or a refurbished Hardware unit (each, "Replacement Hardware") or (iii) refund the original purchase price in return for the Hardware, at PDQ's sole discretion. Additionally, if the Hardware or a component incorporated within it is no longer available, PDQ may, at its sole discretion, replace the Hardware with a similar product of similar function (such product shall also be referred to herein as "Replacement Hardware"). The warranty on the Replacement Hardware will be the longer of (a) the remaining Warranty Period of the original Hardware or (b) 6 months from the date of replacement or repair. PDQ provides this Warranty (1) only to the person or entity that originally purchased the Hardware from PDQ or from one of its authorized resellers or distributors and (2) only for Hardware purchased and delivered within the United States. THIS SECTION SETS FORTH YOUR SOLE AND EXCLUSIVE REMEDY FOR BREACH OF THE WARRANTY SET FORTH IN THIS SECTION.

Exclusions.

PDQ will have no warranty obligations with respect to any Hardware if PDQ determines, in its reasonable discretion, that such Hardware has been damaged due to (i) misuse, accident (including, without limitation, collision, fire and the spillage of liquid or food), neglect, abuse, alteration, unusual stress or modification; (ii) improper or unauthorized repair, installation, testing, or storage; (iii) operation of the Hardware outside the permitted or intended uses described by PDQ; (iv) use with third party products for which the Hardware was not intended for use in conjunction with; (v) breakdowns, fluctuations, or interruptions in electric power or the telecommunications network or (vi) acts of God and other forces beyond PDQ's reasonable control, such as Internet or power outages, wars, riots, terrorism, labor disputes, earthquakes, floods or other events of "force majeure." This Warranty does not apply to consumable parts (such as batteries), Hardware marked as "sample" or "Not for Sale" or Hardware that is sold "AS IS". Unauthorized use of the Hardware or software embedded therein can impair the Hardware's performance and may invalidate this Warranty.

The Hardware chassis is a BHMA certified door lock in part or full depending upon model and current testing achievements. Contact factory for current product status. The Hardware must be correctly installed and kept in good condition. You assume all risk associated with use of the Hardware, including with any third party parts, components, hardware, software and services you select, including without limitation regarding the suitability, installation and performance thereof.

Ownership.

When Hardware is exchanged, any replacement item becomes your property and the replaced item becomes PDQ's property. The replacement item provided is subject to the same warranties and all of the other terms and conditions of the original item. When a refund is given, the Hardware for which the refund is provided must be returned to PDQ and becomes PDQ's property.

Warranty Return Policy.

Hardware must be returned during the Warranty Period, in accordance with the return procedure set forth at the Terms of Service to be eligible for repair, replacement or refund under the Warranty. The Hardware owner will be responsible for all shipping costs for Hardware that is returned and determined by PDQ to be ineligible. When filing a claim under the Warranty, you must specify and provide sufficient detail about the alleged defect or nonconformity.

DISCLAIMER OF WARRANTIES.

EXCEPT AS EXPRESSLY STATED IN THIS WARRANTY, AND TO THE MAXIMUM EXTENT PERMITTED BY LAW, (I) PDQ DISCLAIMS ALL EXPRESS, IMPLIED, AND STATUTORY WARRANTIES AND CONDITIONS WITH RESPECT TO THE PRODUCT, INCLUDING THE IMPLIED WARRANTIES OF MERCHANTABILITY AND FITNESS FOR A PARTICULAR PURPOSE; (II) PDQ LIMITS THE DURATION OF ANY APPLICABLE IMPLIED WARRANTIES OR CONDITIONS TO THE DURATION OF THIS LIMITED WARRANTY; (III) YOU USE THE HARDWARE AT YOUR OWN DISCRETION AND RISK AND (IV) YOU WILL BE SOLELY RESPONSIBLE FOR (AND PDQ DISCLAIMS) ANY AND ALL LOSS, LIABILITY, OR DAMAGES, INCLUDING TO YOUR HOME, DEVICES, OR PROPERTY, RESULTING FROM YOUR USE OF THE HARDWARE, SERVICES, OR INFORMATION PROVIDED IN CONNECTION THEREWITH.

LIMITATION OF DAMAGES.

IN ADDITION TO THE ABOVE WARRANTY DISCLAIMERS, TO THE MAXIMUM EXTENT PERMITTED BY LAW, NEITHER PDQ NOR ITS SUPPLIERS SHALL BE RESPONSIBLE OR LIABLE WITH RESPECT TO ANY SUBJECT MATTER OF THIS AGREEMENT OR TERMS OR CONDITIONS RELATED THERETO UNDER ANY BREACH OF CONTRACT, NEGLIGENCE, STRICT LIABILITY OR ANY OTHER THEORY (I) FOR LOSS OR INACCURACY OF DATA OR COST OF PROCUREMENT OF SUBSTITUTE GOODS, SERVICES OR TECHNOLOGY OR (II) FOR ANY INDIRECT, INCIDENTAL OR CONSEQUENTIAL DAMAGES INCLUDING, BUT NOT LIMITED TO BUSINESS INTERRUPTION, LOSS OF REVENUES, LOSS OF PROFITS. THE FOREGOING SHALL APPLY EVEN IF PDQ HAS BEEN ADVISED OF THE POSSIBILITY OF SUCH DAMAGES. TO THE MAXIMUM EXTENT PERMITTED BY LAW, PDQ'S AGGREGATE CUMULATIVE LIABILITY HEREUNDER SHALL NOT EXCEED THE AMOUNT ACTUALLY PAID FOR THE HARDWARE BY THE ORIGINAL PURCHASER. CERTAIN STATES, PROVINCES OR JURISDICTIONS DO NOT ALLOW THE LIMITATION OF LIABILITY FOR INCIDENTAL OR CONSEQUENTIAL DAMAGES, SO THE EXCLUSIONS SET FORTH ABOVE MAY NOT APPLY TO YOU.

Your Rights and This Warranty.

This Warranty gives you specific legal rights. You may also have other legal rights that vary by state, province or jurisdiction. The disclaimers, exclusions, and limitations of liability under this Warranty will not apply to the extent prohibited by applicable law. For a full description of your legal rights you should refer to the laws applicable in your jurisdiction and you may wish to contact a relevant consumer advisory service.

Electrified Hardware Warranty

Electrified Products	
MR, XGT, GT, 6EW Series	2-Year Warranty

PDQ Manufacturing Limited Warranty

PDQ Manufacturing ("PDQ") warrants that, during the applicable warranty period set forth in the chart to the left, its products will be free from defects in workmanship and materials under normal use and service conditions. If a product or a component part thereof is found to be defective, PDQ will, at its sole discretion, either repair or replace such defective item. If PDQ no longer manufactures the particular product or component, PDQ reserves the right to substitute an item which PDQ deems to be comparable or superior in its place.

A warranty claim must be initiated by calling PDQ's toll-free number at 800-441-9692. A brief description of the defect will be required, and further instructions for returning the product will be given. The provision of return instructions is not a guarantee that the product will be covered under this warranty.

This warranty does not cover:

- Defects or damage arising from improper installation; lack of or improper maintenance; improper storage, shipping or handling; corrosion; erosion; ordinary wear and tear; misuse or abuse; or accident.
- Products which have been modified in any way, regardless of whether such modification caused or contributed to the alleged defect.
- The protective coatings and finishes applied to the surface of the product (wear or tarnishing of such finishes is considered "ordinary wear and tear").
- Labor costs, including the costs of removing and reinstalling the product.
- Shipping charges incurred in returning the product to PDQ.
- This Limited Warranty does not apply to ANSI A156.2 Grade 2 Key-In-Lever product installed on Educational Facilities.

All products returned to PDQ will be inspected to verify that (1) the alleged defect does exist, and (2) none of the exclusionary conditions listed above (abuse, corrosion, modification, etc.) is present. Products deemed not to be "in warranty" will be returned to the customer at the customer's expense.

THIS WARRANTY IS EXCLUSIVE AND IN LIEU OF ALL OTHER WARRANTIES, EXPRESS AND IMPLIED, INCLUDING THE IMPLIED WARRANTIES OF MERCHANTABILITY AND FITNESS FOR A PARTICULAR PURPOSE.

PDQ'S MAXIMUM LIABILITY HEREUNDER IS LIMITED TO THE ORIGINAL PURCHASE PRICE OF THE PRODUCT.

PDQ SHALL NOT BE LIABLE FOR ANY INCIDENTAL, CONSEQUENTIAL, INDIRECT, SPECIAL, EXEMPLARY OR PUNITIVE DAMAGES, WHETHER BASED ON CONTRACT, WARRANTY, TORT (INCLUDING STRICT LIABILITY AND NEGLIGENCE), PATENT INFRINGEMENT OR ANY OTHER THEORY OF LIABILITY, EVEN IF ADVISED OF THE POSSIBILITY OF SUCH DAMAGES.

NO AGENT, SALES REPRESENTATIVE OR DEALER HAS THE AUTHORITY TO INCREASE OR ALTER PDQ'S OBLIGATIONS UNDER THIS WARRANTY.

PHONE:
800.441.9692

TECH SUPPORT:
866.874.3662

EMAIL:
support@pdqlocks.com

HEADQUARTERS:
2230 Embassy Drive
Lancaster, PA 17603
P.O. Box 6426
Lancaster, PA 17607

REGIONAL DISTRIBUTION CENTERS:
Lancaster, PA • Norcross, GA
Kansas City, MO • Denver, CO
Auburn, WA

DESIGN OFFICE:
Milan, Italy

pdqsmart.com



pdqlocks.com