



SCHLAGE

B Series

Commercial grade deadbolts





Put your trust in the name you know

Contents

- 4-5 Mechanical lock guide
- 6-7 B Series overview
- 8-9 B600/700/800 performance features and exploded view
- 10 Designs
- 11 Finishes
- 12-13 Deadbolt functions
- 14-15 B500 performance features and exploded view
- 16 Designs and finishes
- 17 Deadbolt functions
- 18-19 B250 performance features and exploded view
- 20 Designs and finishes
- 21 Deadbolt functions
- 22 Cylinders and key systems
- 23 Standard cylinders and Primus XP high security cylinders
- 24 Full size interchangeable core
- 25 Small format interchangeable core
- 26 Latches and bolts
- 27 Strikes, thumbturns and inside plates
- 28 Accessories and other parts
- 29 Tailpieces
- 30 Specifications and certifications

Pictured here: B250 (Grade 2) deadbolt and D Series plymouth knob shown in 626 satin chrome

Cover photo: B500 (Grade 2) deadbolt with AL Series neptune lever in 626 satin chrome

For more than 90 years, Schlage® has been providing innovative security solutions for schools, hospitals, hotels, condominiums and a host of other commercial buildings. Today, Schlage is at the forefront of cutting-edge technology including wireless security, access control systems including readers, credentials and biometrics. With a wide range of products, styles and finishes, Schlage has what you need, no matter how demanding your project specifications may be. And, we stand behind every product we make with the best after-sales service in the business. It's this commitment to design, performance and technology that ensures you can stand behind our products too.

Real security is knowing exactly what you want and getting it

When you know exactly what you want, you don't want to waste time finding out whether it meets your project specifications. That's why we offer the world's largest team of hardware specification writers to help you and your clients turn your vision into reality. And when it comes to products, our commercial suiting options, wide variety of lever designs and rich selection of finishes give you the tools you need to make your projects perfect. You know what you want. With Schlage you can be sure you'll get it.

Safety, security and confidence

When you choose a Schlage lock you can be sure you've done the job right the first time. After all, our products are among the most durable and dependable on the market today. Our locks are easy to install, and simple to repair and maintain. That means fewer callbacks for you, and total safety and security for your customers.

Be sure to ask your SSC representative to tell you about **Custom Solutions** by Allegion. To learn more visit allegion.com/us.



Quiet Solutions



Custom Décor



High Security and Safety



Environmental Solutions



Flexible Configurations





Tubular interconnected locks



Tubular locks



Tubular interconnected locks







Cylindrical locks



Cylindrical interconnected locks

CS200 Series	S Series	S200 Series	A Series	H Series
Grade 2	Grade 2		Grade 2	
Security level:				
ANSI/BHMA certified A156.12-2013 Exceeds 400,000 ANSI cycles Medium traffic	ANSI/BHMA certified A156.2-2011 Exceeds 400,000 ANSI cycles Light traffic	- - Exceeds 400,000 ANSI cycles Medium traffic	ANSI/BHMA certified A156.2-2011 Exceeds 400,000 ANSI cycles Medium traffic	- - Exceeds 400,000 ANSI cycles Medium traffic
Typical applications:				
Exterior Interior New construction Retrofit	- Interior - Retrofit	Exterior Interior New construction Retrofit	Exterior Interior New construction Retrofit	Exterior Interior - Retrofit
Functions available:				
1 Function - -	6 Functions - -	5 Functions - -	11 Functions - -	5 Functions - -
Design options:				
7 Finishes 15 Lever styles - 1 Matching rose 2 Interior escutcheons Tactile warning available	7 Finishes 4 Lever styles - 1 Matching rose - Tactile warning available	7 Finishes 4 Lever styles - 1 Matching rose 1 Interior escutcheon -	10 Finishes 1 Lever style 4 Knob styles 1 Matching rose - -	7 Finishes 1 Lever style 2 Knob styles 1 Matching rose 1 Interior escutcheon -
Often used in:				
Commercial Multi-family Office	Commercial Multi-family Office	Commercial Multi-family Office	Commercial Govt/military Healthcare Hospitality Office Retail	Commercial Govt/military Multi-family

Not all functions and finishes available with all products. Please consult your SSC representative for details.

				
Cylindrical locks	Deadbolts	Cylindrical locks	Cylindrical locks	Mortise locks
AL Series	B Series	D Series	ND Series	L Series
Grade 2	Grade 2	Grade 1	Grade 1	Grade 1
Security level:				
ANSI/BHMA certified A156.2-2011 Exceeds 400,000 ANSI cycles Medium traffic	ANSI/BHMA certified A156.36-2010 Exceeds 150,000/250,000 ANSI cycles High traffic, heavy-duty	ANSI/BHMA certified A156.2-2011 Exceeds 1,000,000 ANSI cycles High traffic	ANSI/BHMA certified A156.2-2011 Exceeds 1,000,000 ANSI cycles Heavy-duty traffic	ANSI/BHMA certified A156.13-2012 Exceeds 1,000,000 ANSI cycles Heavy-duty traffic
Typical applications:				
Exterior Interior New construction Retrofit	Exterior - New construction Retrofit	Exterior Interior - Retrofit	Exterior Interior New construction Retrofit	Exterior Interior New construction Retrofit
Functions available:				
10 Functions - -	7 Functions - -	6 Functions - -	14 Functions 2 Electrified -	29 Functions 6 Electrified Vandlgard® available
49 Functions 4 Electrified Vandlgard® available				
Design options:				
10 Finishes 4 Lever styles - 1 Matching rose - Tactile warning available	10 Finishes - - - - Indicator rose	10 Finishes - 3 Knob styles 1 Matching rose - -	9 Finishes 5 Lever styles - 2 Matching roses - Tactile warning available	13 Finishes 32 Lever style 3 Knob styles 5 Matching roses 2 Escutcheons Tactile warning available Antiligature available
Often used in:				
Commercial Healthcare Hospitality Office Retail	Commercial/institutional Govt/military Heavy-duty residential Hospitality Office Retail	Institutional Govt/military Hospitality Retail	Institutional Education Healthcare Office Retail	Commercial/institutional Govt/military Education Healthcare Office Retail

This chart shows the most common uses/applications. These products are often used in other applications in addition to those listed.

Rev. 04/14

B Series

B250 deadlatches

B500 deadbolts

B600/700/800 deadbolts

Auxiliary locks for added security

Auxiliary locks not only provide added protection for exterior entrance doors, they can also protect common use areas like pool gates and storage/utility spaces from unauthorized access. Schlage delivers flexibility and performance with a full line of auxiliary locks that range from heavy-duty to high-traffic performance, and complement our lock lines. A choice of styles and finishes ensures a consistent look across doors and throughout your building.

We don't compromise on security

The safety and security of your clients' buildings is something we take very seriously. That's why every Schlage lock and deadbolt undergoes intensive testing to determine its ANSI grade level:

- Cycle tests
- Resistance tests
- Door impact tests
- Warped door tests
- Bolt strength tests

We pay attention to these details so you can focus on creating a functional and aesthetically pleasing environment for your clients. In fact, every one of our B Series locks meets ANSI Grade 1 or Grade 2 standards for safety.



Pictured here: B500 (Grade 2) deadbolt and ND Series Sparta lever shown in 626 satin chrome

B Series at a glance

B250 • B500 • B600/700/800

B250 Series: Grade 2 deadlatch

B500 Series: Grade 2 deadlock

B600 Series: Grade 1 deadlock











B700 Series: Grade 1 deadlock w/ Primus XP controlled access cylinder

B800 Series: Grade 1 deadlock w/ Primus XP high security cylinder, UL437 rated

Functions

Product	ANSI	Deadbolt functions								Deadlatch functions	
		Single cylinder deadbolt	Double cylinder deadbolt	Classroom deadbolt	Door bolt occupancy indicator	Door bolt	Door bolt with trim	Cylinder only deadbolt	Cylinder only X blank plate deadbolt	Single cylinder deadlatch	Double cylinder deadlatch
Interior		Thumbturn	Keyed	Thumbturn	Thumbturn	Thumbturn	Thumbturn	No trim	Blank plate	Thumbturn	Keyed
Exterior		Keyed	Keyed	Keyed	Indicator	No trim	Blank plate	Keyed	Keyed	Keyed	Keyed
B250	Grade 2									B250PD	B252PD
B500	Grade 2	B560P	B562P	B563P	B571	B580	B581		B561P		
B600	Grade 1	B660P	B662P	B663P		B680		B664P	B661P		
B700	Grade 1	B760P	B762P	B763P				B764P	B761P		
B800	Grade 1	B860P	B862P	B863P				B864P	B861P		

Finishes

									
605 Bright brass	606 Satin brass	609 Antique brass	612 Satin bronze	613 Oil rubbed bronze	619 Satin nickel*	625 Bright chromium plated	626 Satin chromium plated	626AM Antimicrobial coating*	643e Aged bronze

* Finish not available on B250

e = an equivalent finish to the BHMA standard.

ADA-compliant products

In compliance with the American National Standards Institute (ANSI A117.1) and the Americans with Disabilities Act (ADA), Schlage Lock Company offers a wide selection of locks designed for the needs of the physically challenged.

This act is designed to provide protection for people with disabilities.

The intent of ADA is that owners of certain types of buildings must remove barriers and provide people with disabilities with access equal to, or similar to, that available to the general public.

Product information and specifications contained in this catalog are subject to change without notice. Please consult the factory.

B600/700/800 Series

The B600/700/800 Series are Schlage's highest grade deadbolt locks. Choose the 600 for Grade 1 security in high-traffic commercial applications. Choose the 700 or 800 and get standard a Primus XP controlled access cylinder (700) or Primus® XP high security cylinder with UL 437 rating (800). A variety of functions and finishes makes the B600/700/800 Series a versatile choice for added security no matter where you use it.

Pictured here: B600 (Grade 1) deadbolt with D Series Orbit knob shown in 626 satin chrome



ELECTRICAL

The toughest deadbolts in the business

- 1" (25 mm) throw, high-strength steel alloy deadbolt with hardened steel roller resists sawing and kick-in attacks
- Precision-built solid brass 6-pin cylinders with phosphor bronze springs and nickel silver pins ensure long life and smooth operation
- Tough nickel silver keys for smooth, long-lasting operation
- Exclusive concealed wood frame reinforcer protects wood jamb against kick-in attacks
- Free-spinning solid cylinder collar resists wrenching and prying
- Large inside thumbturn makes it easy to throw and retract deadbolt
- Metal shield protects bolt from ice-pick attack through the door
- Hardened steel ball-bearings protect mounting bolts from drill attack

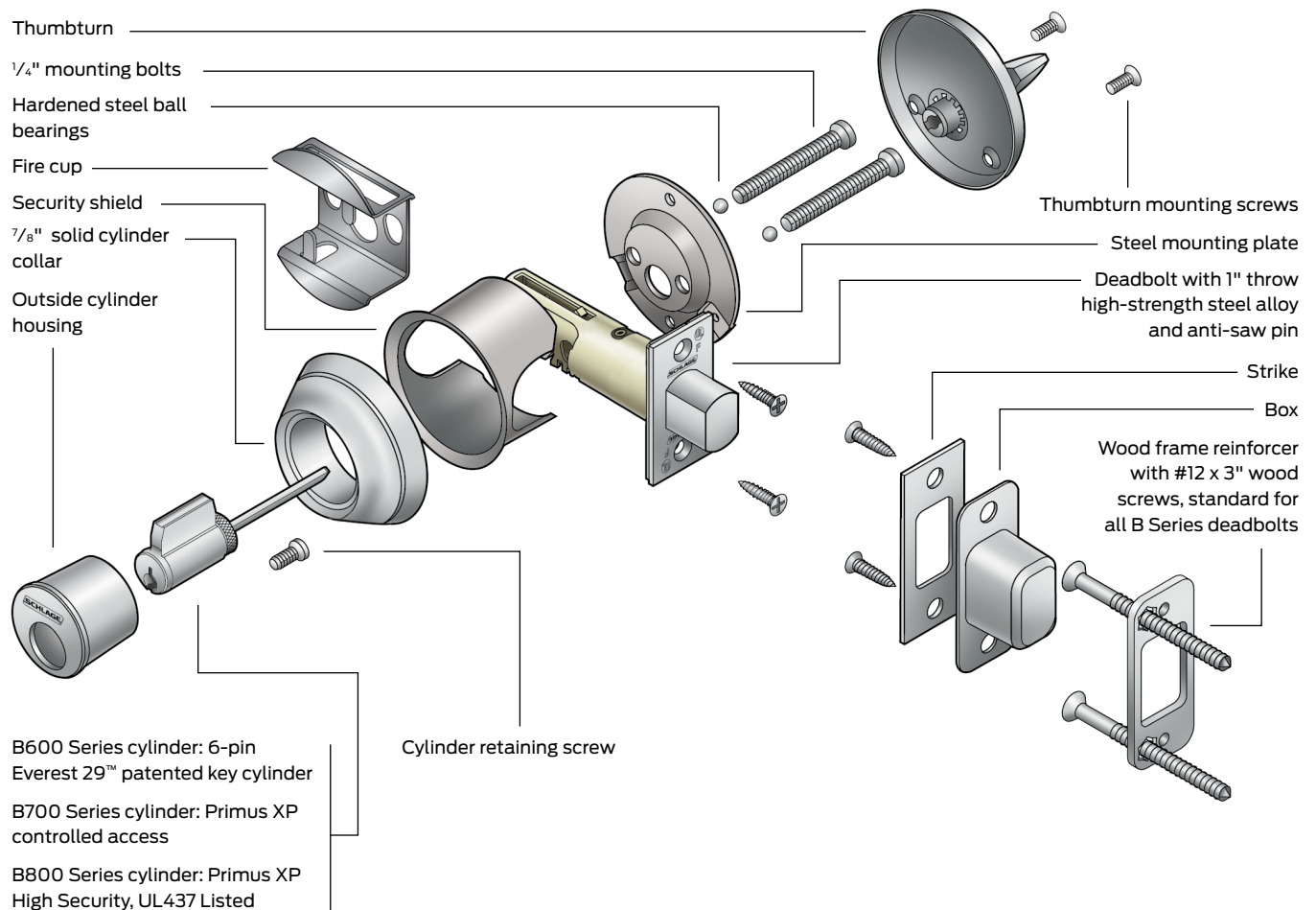

Deadbolt designs

B600 Series

Schlage's toughest heavy duty Grade 1 commercial deadbolt.

Furnished with conventional cylinder standard.

Also available with full size interchangeable core cylinder or small format interchangeable core (SFIC) cylinder.

Requires 2 1/8" (54mm) prep. UL10B listing standard for auxiliary lock on A label fire doors.



B700 Series

Same lock as B600 Series but furnished with Primus XP controlled access cylinder for patented key control, geographical exclusivity and resistance to picking and impressioning. Also available with Primus XP full size interchangeable core cylinder.







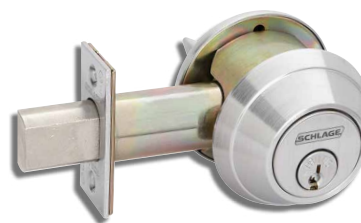





B800 Series

Same lock as B700 Series but Primus XP high security cylinder is UL437 listed to resist drilling and other forms of physical attack. Not available in interchangeable core.



All designs shown in 626 satin chrome

Deadbolt finishes





										
	605 Bright brass	606 Satin brass	609 Antique brass	612 Satin bronze	613 Oil rubbed bronze	619 Satin nickel	625 Bright chromium plated	626 Satin chromium plated	626AM Antimicrobial coating	643e Aged bronze
B600/700/800										
B600	•	•	•	•	•	•	•	•	•	•
B700	•	•	•	•	•	•	•	•	•	•
B800	•	•	•	•	•	•	•	•	•	•

e = an equivalent finish to the BHMA standard.

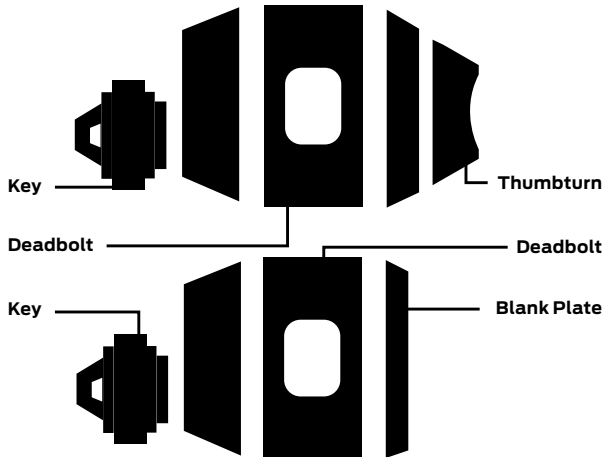
Deadbolt functions

ANSI A156.5 bored deadbolt locks grade 1



-  Standard cylinder.
-  FSIC - full size interchangeable core option.
-  SFIC - small format interchangeable core option.
-  Complies with ADA accessibility guidelines.

***Caution:**

Double cylinder locks on any door are a life safety hazard in times of emergency and their use is not recommended. Installation should be in accordance with existing codes only.

ADA compliant:

Schlage Lock Company offers a wide selection of locks designed to meet the Americans with Disabilities Act.

Product information and specifications contained in this catalog are subject to change without notice. Please consult the factory.

B600 Series

Schlage ANSI
B660P E0151

Single cylinder deadbolt

- Deadbolt thrown or retracted by key outside or thumbturn inside.

Outside Inside



Schlage ANSI
B661P E0161

One-way deadbolt

- Deadbolt thrown or retracted by key outside.
- Blank plate with exposed screws inside.

Outside Inside



B700 Series

Schlage ANSI
B760P E0151

Single cylinder deadbolt

- Deadbolt thrown or retracted by key outside or thumbturn inside.

Outside Inside



Schlage ANSI
B761P E0161

One-way deadbolt

- Deadbolt thrown or retracted by key outside.
- Blank plate with exposed screws inside.

Outside Inside



B800 Series

Schlage ANSI
B860P E0151

Single cylinder deadbolt

- Deadbolt thrown or retracted by key outside or thumbturn inside.

Outside Inside



Schlage ANSI
B861P E0161

One-way deadbolt

- Deadbolt thrown or retracted by key outside.
- Blank plate with exposed screws inside.

Outside Inside



Schlage ANSI
B662P* **E0141**
Double cylinder deadbolt

- Deadbolt thrown or retracted by key on either side.

Outside Inside



Schlage ANSI
B663P **E0171**
Classroom deadbolt

- Deadbolt thrown only by key outside.
- Deadbolt retracted by key outside or thumbturn inside.

Outside Inside



Schlage ANSI
B664P **E0101**
Cylinder only deadbolt

- Deadbolt thrown or retracted by key one side.
- No trim on inside.

Outside Inside



Schlage ANSI
B680 **E0191**
Door bolt

- Deadbolt thrown or retracted by thumbturn inside.
- No outside trim.

Outside Inside



Schlage ANSI
B762P* **E0141**
Double cylinder deadbolt

- Deadbolt thrown or retracted by key on either side.

Outside Inside



Schlage ANSI
B763P **E0171**
Classroom deadbolt

- Deadbolt thrown only by key outside.
- Deadbolt retracted by key outside or thumbturn inside.

Outside Inside



Schlage ANSI
B764P **E0101**
Cylinder only deadbolt

- Deadbolt thrown or retracted by key one side.
- No trim on inside.

Outside Inside



Schlage ANSI
B862P* **E0141**
Double cylinder deadbolt

- Deadbolt thrown or retracted by key on either side.

Outside Inside



Schlage ANSI
B863P **E0171**
Classroom deadbolt

- Deadbolt thrown only by key outside.
- Deadbolt retracted by key outside or thumbturn inside.

Outside Inside



Schlage ANSI
B864P **E0101**
Cylinder only deadbolt

- Deadbolt thrown or retracted by key one side.
- No trim on inside.

Outside Inside





B500 Series

The B500 Series deadbolt is a revolutionary new deadbolt that delivers higher security, tougher performance and the ultimate in installation versatility.

Designed by locksmiths for locksmiths, the B500 Series deadbolt can be fitted with any Schlage cylinder, fits virtually every door you service, enhances lock strength on the jamb side of the door and will change forever the way you look at deadbolts.

Pictured here: B500 (Grade 2) deadbolt with ND Series Athens lever shown in 626 satin chrome

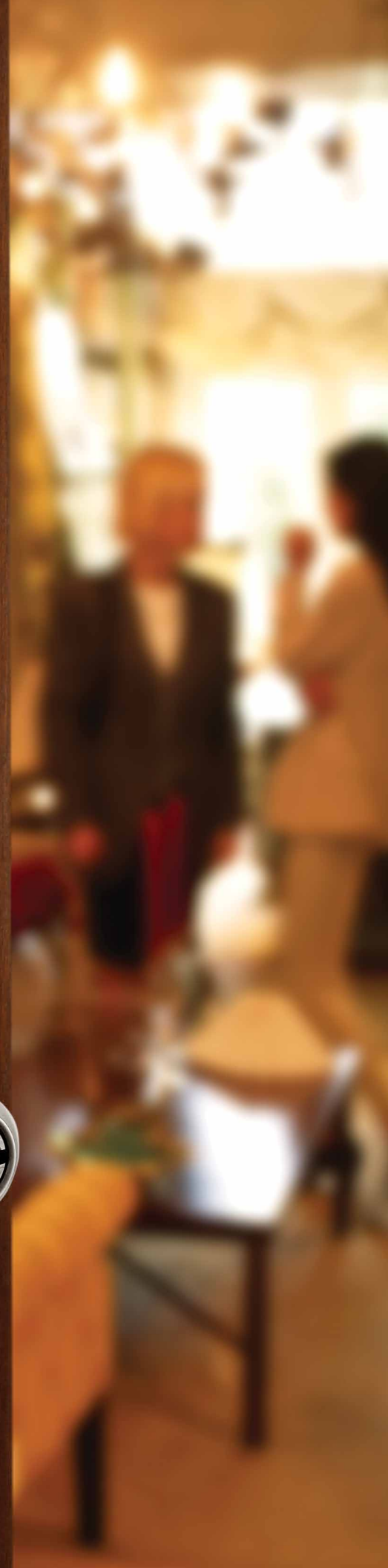

Deadbolt designs

B500 Series

A versatile and economical Grade 2 deadbolt for medium duty commercial and heavy duty residential applications.

Furnished with conventional cylinder standard.

Available with Primus XP high security cylinder, Primus XP UL437 Listed high security cylinder, full size interchangeable core cylinder, Primus XP interchangeable core cylinder, or small format interchangeable core (SFIC) cylinder.

Fits 2 1/8" (54 mm) prep standard and anti-pry shield can be removed to fit 1 1/2" (38 mm) prep.

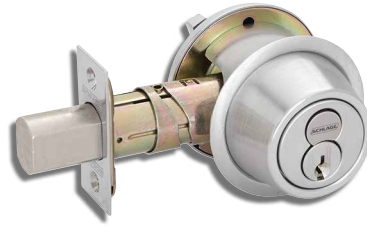

Full size interchangeable core

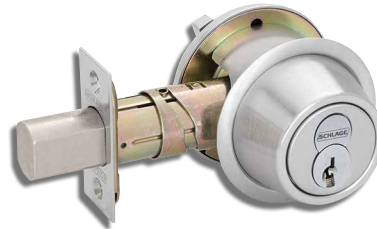

Small format interchangeable core



Thumbturn for B500

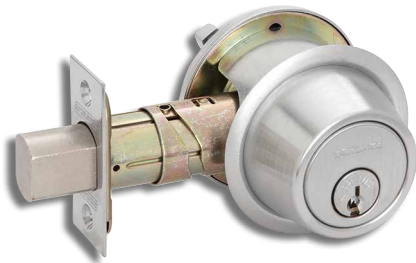

Design shown in 626 satin chrome plated



B500 Series with occupied indicator (B571)

Deadbolt finishes



605
Bright brass



606
Satin brass

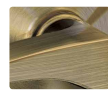

609
Antique brass



612
Satin bronze



613
Oil rubbed bronze



619
Satin nickel



625
Bright chromium plated

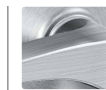

626
Satin chromium plated

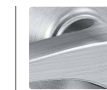

626AM
Antimicrobial coating



643e
Aged bronze





Product	605	606	609	612	613	619	625	626	626AM	643e
B500

e = an equivalent finish to the BHMA standard.

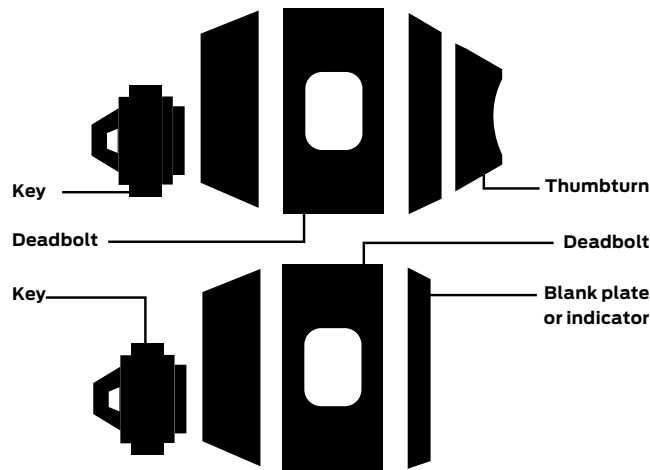
Deadbolt functions

ANSI A156.5 bored deadbolt locks



-  Standard cylinder.
-  FSIC - full size interchangeable core option.
-  SFIC - small format interchangeable core option.
-  Complies with ADA Accessibility Guidelines.

***Caution:**

Double cylinder locks on any door are a life safety hazard in times of emergency and their use is not recommended. Installation should be in accordance with existing codes only.

ADA compliant:

Schlage Lock Company offers a wide selection of locks designed to meet the Americans with Disabilities Act.

Schlage	ANSI
B560P	E0152
Single cylinder deadbolt	
<ul style="list-style-type: none"> • Deadbolt thrown or retracted by key outside or thumbturn inside. 	

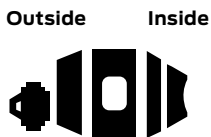

Schlage	ANSI
B561	E0162
Cylinder only x blank plate deadbolt	
<ul style="list-style-type: none"> • Deadbolt thrown or retracted by key outside. • Blank plate with exposed screws inside. 	

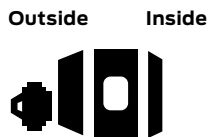

Schlage	ANSI
B562P*	E0142
Double cylinder deadbolt	
<ul style="list-style-type: none"> • Deadbolt thrown or retracted by key either side. 	

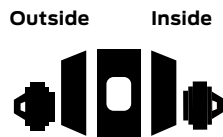

Schlage	ANSI
B563	E0172
Classroom deadbolt	
<ul style="list-style-type: none"> • Deadbolt thrown or retracted by key outside. • Inside units retracts bolt only. 	

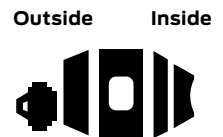

Schlage	ANSI
B571	-
Door bolt occupancy indicator	
<ul style="list-style-type: none"> • Deadbolt thrown or retracted by thumbturn inside • Outside indicator displays "In use" or "Vacant" • Requires 1 1/2" cross bore prep • Not UL rated 	

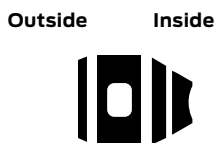

Schlage	ANSI
B580	E0192
Door bolt	
<ul style="list-style-type: none"> • Deadbolt thrown or retracted by trim unit only. • Requires 1 1/2" cross bore prep 	

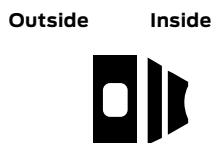

Schlage	ANSI
B581	E01112
Door bolt with trim	
<ul style="list-style-type: none"> • Deadbolt thrown or retracted by trim unit only. • Blank plate outside. • Requires 1 1/2" cross bore prep 	

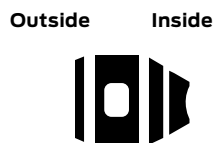



B250 Series

Ideally suited for pool, apartment and condominium gates, utility panels and pipe chases, the Schlage B250 Series is tough, reliable and has a proven design that has been the industry standard for decades.

Pictured here: B250 deadbolt with ND Series Rhodes lever shown in 626 satin chrome



The industry standard for tubular deadlatches.

- $\frac{9}{16}$ " (14 mm) throw deadlatch resists pry-in attacks and "shimming" of the latch
- Precision-built brass 6-pin cylinders with phosphor bronze springs and nickel silver pins ensure long life and smooth operation
- Tough nickel silver keys for smooth, long-lasting operation
- Exclusive concealed wood frame reinforcer protects wood jamb against kick-in attacks
- Cylinder collar reinforced with security inserts to resist wrenching and prying
- Thumbturn "holdback" feature retains the deadlatch in a retracted position when desired

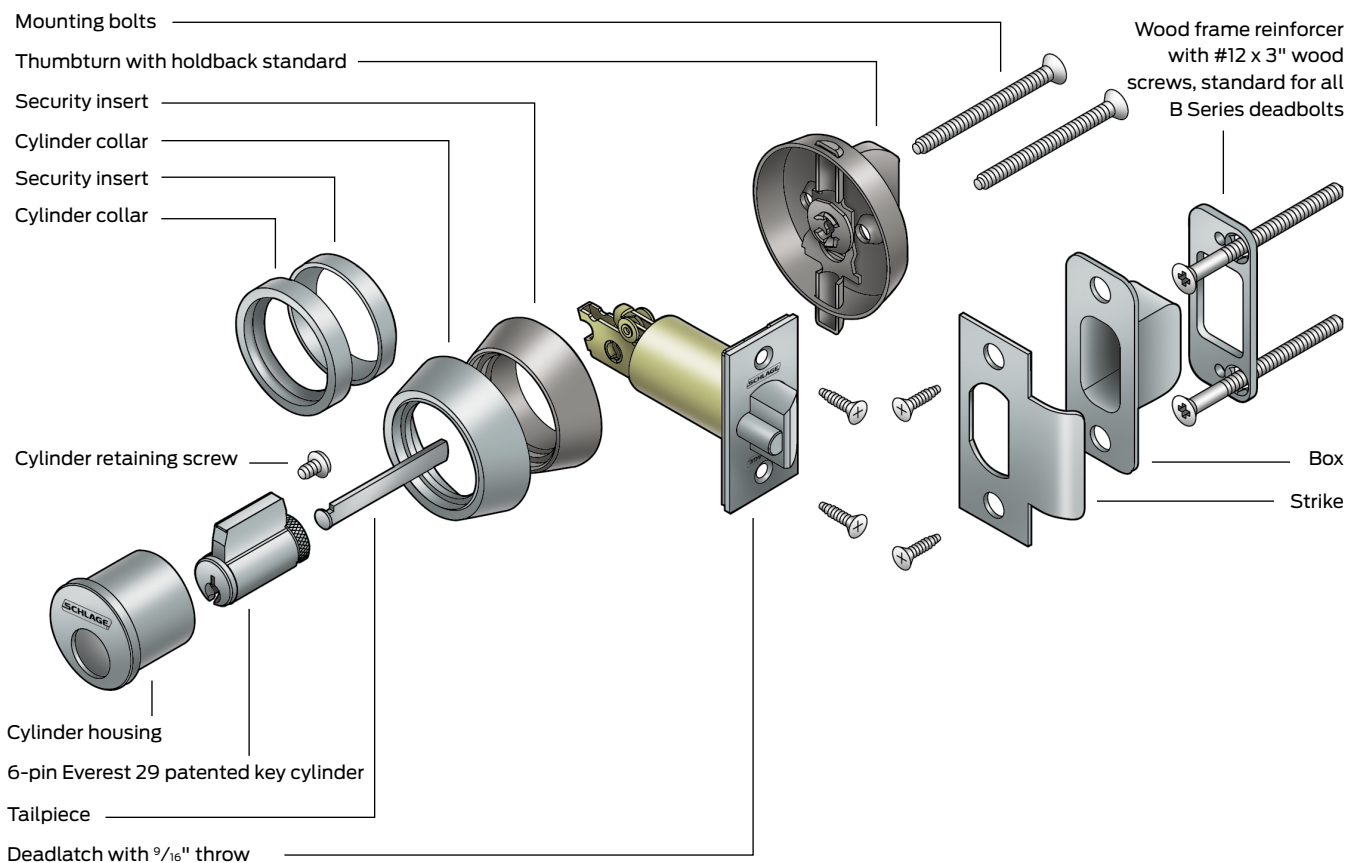

Deadbolt designs

B250 Series

Considered the industry standard for tubular deadlatches for decades, the B250 Series is ideal for pool, apartment and condominium gates, utility panels and pipe chases.

Furnished with conventional cylinder standard.

Available with Primus XP access control cylinder, Primus UL437 Listed high security cylinder, full size interchangeable core cylinder and Primus interchangeable core cylinder.

Designed for 1½" (38 mm) prep.

Optional adapter plates allow easy installation in 2⅛" (54 mm) prep.

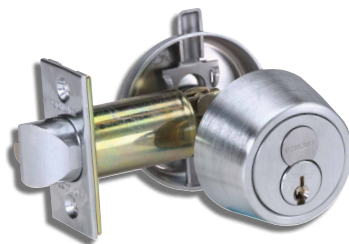

Full size interchangeable core

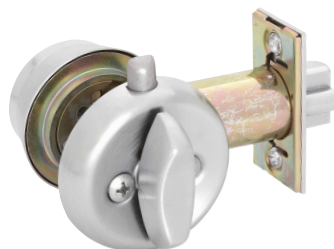



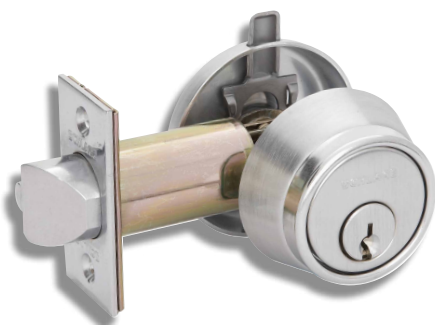



Thumbturn for B250

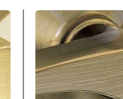

Design shown in 626 satin chromium plated

Deadbolt finishes



						
605 Bright brass	606 Satin brass	609 Antique brass	612 Satin bronze	613 Oil rubbed bronze	625 Bright chromium plated	626 Satin chromium plated

Product	605	606	609	612	613	625	626
B250	•	•	•	•	•	•	•

Deadbolt functions

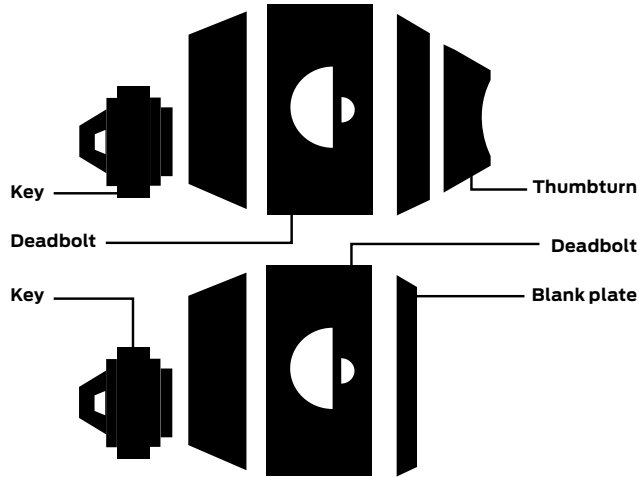
ANSI A156.5 bored dead locks



 Standard cylinder.
 FSIC - full size interchangeable core option.

***Caution:**
 Double cylinder locks on any door are a life safety hazard in times of emergency and their use is not recommended. Installation should be in accordance with existing codes only.

Schlage ANSI
B250 **E0122**
Single cylinder deadlatch

- Deadlatch retracted by key outside or thumbturn inside.
- Holdback feature standard.

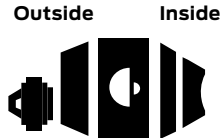

Schlage ANSI
B252* **E0112**
Double cylinder deadlatch

- Deadlatch retracted by key either side.
- No holdback.

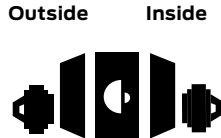

Cylinders and key systems

Protect new key systems with Everest 29

Schlage can help you design a system that can grow and change along with your needs, allowing you the flexibility to upgrade your security without the need to replace all your cylinders.

Upgrade existing classic key systems with Primus XP

Schlage offers key system solutions that are ideal for upgrading an existing key system to control key management. Our patent-protected cylinders help prevent unauthorized duplication and can be integrated into virtually any existing system.

What it operates		What it is	
<ul style="list-style-type: none"> Everest 29 Primus[®] XP cylinders Everest 29 restricted cylinders Everest 29 open cylinders 	<ul style="list-style-type: none"> UL 437 version UL 437 versions provide drill and pick resistance and withstand physical attack High security cylinders have a second set of pins for added security Patented key control sold with various levels of geographic exclusivity Keys operate high security, as well as restricted security or standard security cylinders Available only in conventional 	<ul style="list-style-type: none"> UL 437 version UL 437 versions provide drill and pick resistance and withstand physical attack High security cylinders have a second set of pins for added security Patented key control sold with various levels of geographic exclusivity Keys operate high security, as well as restricted security or standard security cylinders Available only in conventional 	<ul style="list-style-type: none"> Primus XP cylinders Classic cylinders
<ul style="list-style-type: none"> Everest 29 Primus XP cylinders Everest 29 restricted cylinders Everest 29 open cylinders 	<p>Controlled access</p> <ul style="list-style-type: none"> Patented key control sold with various levels of geographic exclusivity High security cylinders have a second set of pins for added security and pick resistance Keys operate high security, as well as restricted security or standard security cylinders Available only in conventional and FSIC 	<p>Controlled access</p> <ul style="list-style-type: none"> Patented key control sold with various levels of geographic exclusivity High security cylinders have a second set of pins for added security and pick resistance Keys operate high security, as well as restricted security or standard security cylinders Available only in conventional 	
<ul style="list-style-type: none"> Everest 29 restricted cylinders 	<ul style="list-style-type: none"> Key distribution is restricted duplication must be authorized End user's ID numbers are stamped on all keys, enabling Schlage to identify the source of any unauthorized keys Patent-protected keys are drop-shipped from the factory directly to an end-user specified location to guarantee exclusivity Available in conventional, SFIC and FSIC 	<ul style="list-style-type: none"> Primus XP cylinders Classic cylinders 	
<ul style="list-style-type: none"> Everest 29 open cylinders 	<ul style="list-style-type: none"> Patented key blanks can be stored by commercial locksmiths and security dealers Keys can be duplicated without any paperwork or signature verification Sold only through commercial outlets Available in conventional and FSIC 		<ul style="list-style-type: none"> Keys can be duplicated at most retail and commercial points of sale with no restrictions Recommended only for residential applications or existing commercial systems that cannot rekey Can be upgraded to Primus XP without rekeying the entire facility Available in conventional and FSIC



Standard cylinders

Schlage locks are provided with cylinders precision built to extremely close tolerances and the highest standards of accuracy. Using only solid brass plugs, phosphor bronze springs, and nickel silver keys and bottom pins, ensures long life and ease of operation.

Cylinder plug face available in 606 and 626 finishes only.

Conventional cylinders are available in Classic keyways or in the patented Everest 29 keyways. Specify keyway to differentiate between Everest 29 and Classic.

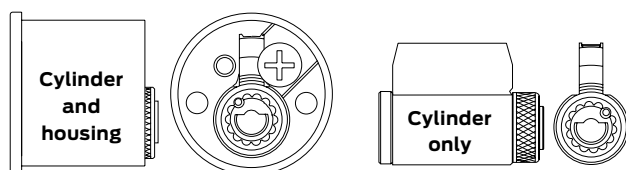

Cylinders for B250 Series (Order tailpieces separately)

Number	Description
22-002	Conventional 6-pin cylinder only
20-729-XP	Primus XP cylinder only
20-529-XP	Primus XP UL437 Listed high security cylinder only
22-019	Conventional 6-pin cylinder in outside housing
20-730-XP	Primus XP cylinder in outside housing
20-530-XP	Primus XP UL437 Listed high security cylinder in outside housing
22-020	Conventional 6-pin cylinder in inside housing
20-731-XP	Primus XP cylinder in inside housing
20-531-XP	Primus XP UL437 Listed high security cylinder in inside housing

This table also applies to discontinued B100, B200 and B400 Series deadlocks.

B500 Series cylinders (single cylinder deadbolts)*

Number	Description	Door thickness
22-003	Conventional classic	1 ³ / ₈ " - 1 ³ / ₄ "
22-XXX	Everest 29, specify section	1 ³ / ₈ " - 1 ⁷ / ₈ "
20-188-XP	Primus XP	
20-190-XP	Primus XP UL	

B500 Series cylinders (double cylinder deadbolts)*

Number*	Description	Door thickness
22-645	Conventional classic	1 ³ / ₈ " - 1 ³ / ₄ "
22-XXX	Everest 29™, specify section	1 ³ / ₈ " - 1 ⁷ / ₈ "
20-745-XP	Primus XP	
20-545-XP	Primus XP UL	

*See price book for more door thicknesses and cylinder parts.

B500 Series cylinders (B561 one way deadbolts)*

Number	Description	Door thickness
22-069	Conventional classic	1 ³ / ₈ " - 2 ¹ / ₄ "
22-XXX	Everest 29, specify section	
20-071-XP	Primus XP	
20-072-XP	Primus XP UL	

Dummy cylinder (simulates cylinder in housing)*

Number	Description
B610-024	B600 / 700 / 800-Series

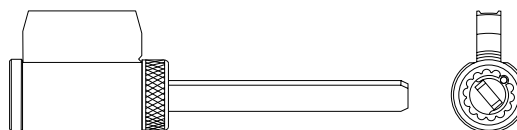

Cylinders for B600/700/800 Series deadlocks (housing not included)

Lockset function	Cylinder number	Door thickness	Cylinder type	
B660, B663	22-644	1 ³ / ₈ " - 2 ¹ / ₂ "	Conventional	
	B661, B664	20-642		1 ³ / ₈ " - 2"
		22-643		2" - 2 ¹ / ₂ "
B662	22-645	1 ³ / ₈ " - 2"		
	22-646	2" - 2 ¹ / ₂ "		
B760, B763	20-744-XP	1 ³ / ₈ " - 2 ¹ / ₂ "		Primus XP
	B761, B764	20-742-XP	1 ³ / ₈ " - 2"	
B762		20-743-XP	2" - 2 ¹ / ₂ "	
	20-745-XP	1 ³ / ₈ " - 2"		
B860, B863	20-746-XP	2" - 2 ¹ / ₂ "	Primus XP UL437 Listed	
	B861, B864	20-544-XP		1 ³ / ₈ " - 2 ¹ / ₂ "
B862		20-542-XP		1 ³ / ₈ " - 2"
	20-543-XP	2" - 2 ¹ / ₂ "		
20-545-XP	1 ³ / ₈ " - 2"			
20-546-XP	2" - 2 ¹ / ₂ "			

Full size interchangeable core (FSIC) 8

Schlage interchangeable core (IC) locksets allow immediate rekeying at the door simply by using the special control key to replace the core in seconds.

B250 Series

Finishes: 605, 606, 609, 612, 613, 625, 626



B500 Series

Finishes: 605, 606, 609, 612, 613, 619, 625, 626, 643e

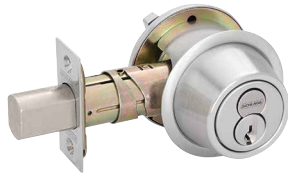

B600/700/800 Series

Finishes: 605, 606, 609, 612, 613, 619, 625, 626, 643e

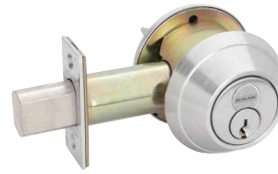

Available in B250, B500, B600 and B700 Series, full size interchangeable cores can be integrated into any 5 or 6-pin Schlage key with no adverse affects on keying capacity.

Full size interchangeable cores and housings - options

- Conventional core
- Primus XP core

Cores available 606 and 626 finish only.
Everest 29 S123 keyway standard.

Full size core



Small format interchangeable core (SFIC)



Available in B500 and B600 Series, the small format IC option is designed for Schlage Everest 29 R Family restricted keyway cores and is also completely compatible with Best®, Falcon, and other small format cores.

- 7-pin uncombined Everest 29 R family restricted keyways
- 7-pin combined Everest 29 R family restricted keyways
- 6-pin uncombined Falcon / Best keyways
- 7-pin uncombined Falcon / Best keyways
- Disposable plastic construction core

Small format core



Disposable construction core

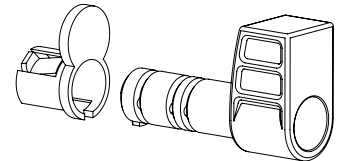

80-033 and 80-043 cores are available in Best A, B, C, D, DD, E, F, G, H, J, K, L, N, O, R, TB and TD keyways. Specify keyway by suffixing "B" to keyway letter, e.g. "AB".

80-036 and 80-037 restricted keyway cores require a letter of authorization from the end user. Schlage assigns the keyway when establishing new Everest 29 restricted key systems.

Latches and bolts

B Series bolt and latch fronts are available in a variety of configurations to fit your door prep dimensions.

Latches are furnished in brass, bronze or chrome finishes compatible with the lock finish.

B250 Series deadlatches

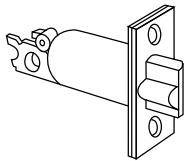

Number	Backset	Description	Housing
12-100	2 ³ / ₈ "	1 ¹ / ₈ " x 2 ¹ / ₄ " - square corner standard	1"
12-103	2 ³ / ₄ "	1 ¹ / ₈ " x 2 ¹ / ₄ " - square corner	1"

B500 Series deadbolts

Square corner bolt

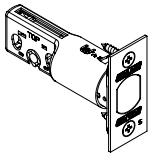

Radius corner bolt

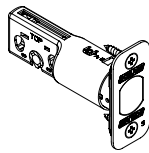

Circular/drive-in bolt

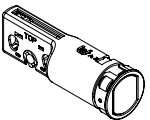

Triple option bolt

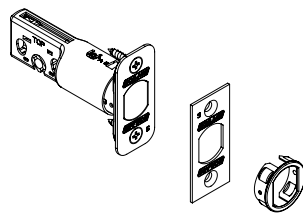

Door reinforcement

Reinforcing unit is required to reinforce and help prevent the collapse of hollow metal doors when locksets are tightly mounted. This kit should be used with long backsets for B Series lock installations in hollow metal doors to prevent lateral movement of the latchbolt. Specify door thickness, 1³/₈" (35 mm) or 1³/₄" (44 mm), when ordering reinforcement kits.

Reinforcement kit 37-001

Kit includes:
Reinforcement
A501-566 for 1³/₈" doors or
A501-565 for 1³/₄" doors

Sleeve
A501-567 for
5" backsets

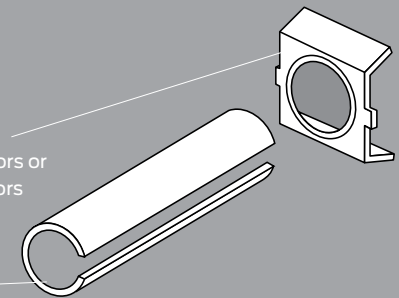

B600/700/800 Series deadbolts

Square corner bolt

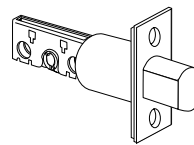

Circular/drive-in bolt

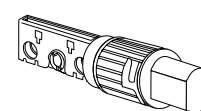

Number	Backset	Description	Housing
12-297	2 ³ / ₈ " or 2 ³ / ₄ " adjustable	1 ¹ / ₈ " x 2 ¹ / ₄ " - square corner	1"
12-317		Circular/drive-in (626 only)	
12-630	2 ³ / ₈ "	1 ¹ / ₈ " x 2 ¹ / ₄ " - square corner	1"
12-640		Circular/drive-in (626 only)	1 ¹ / ₁₆ "
12-631	2 ³ / ₄ "	1 ¹ / ₈ " x 2 ¹ / ₄ " - square corner	1"
12-641		Circular drive-in (626 only)	1 ¹ / ₁₆ "
12-632	3 ³ / ₄ "	1 ¹ / ₈ " x 2 ¹ / ₄ " - square corner	1"
12-642		Circular/drive-in (626 only)	1 ¹ / ₁₆ "
12-633	5"	1 ¹ / ₈ " x 2 ¹ / ₄ " - square corner	1"
12-643		Circular/drive-in (626 only)	1 ¹ / ₁₆ "

Strikes

All B Series strikes are fully reversible for right handed and left handed doors, and are furnished complete with screws. Strike boxes are also included with all standard strikes. B Series deadbolt strikes are also packed with our exclusive wood frame reinforcer or a metal dust box reinforcer for added protection against “kick-in” attack.

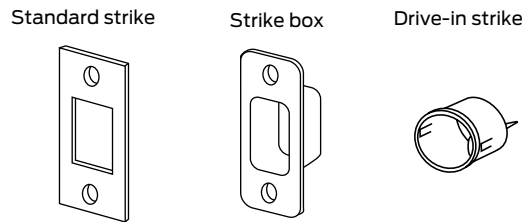

Strikes for deadbolts

B500	B600	Number	Lip length	Description
	x	10-055	-	1 1/8" x 2 3/4" x 3/32" square corner, B600/700/800
x	x	10-064	-	1 3/16" circular drive-in
x	x	10-087	1 3/16"	1 1/4" x 4 7/8" ANSI
x	x	10-092	1 1/8"	1 5/8" x 2 1/4" radius round corner, no box
x	x	10-094	-	1 1/8" x 2 1/4" x 3/32" square corner, no box
x	x	10-095	1 1/8"	1 5/8" x 2 1/4" full lip, no box
x	x	B250-283	-	Box for 10-055, 10-094 and 10-108
x		10-104	-	1/4" round corner 1 1/4" x 3 5/8". 4 hole no reinforcement strike provided. 605, 609, 620, 650 only
x		10-108	-	1 1/8" x 2 3/4" round corner
x	x	10-103		1/4" round corner 1" x 2 1/4", no reinforcement strike provided. 605, 609, 630 only

Strikes for deadlatches

Number	Lip length	Description
10-001	1", 1 1/8", 1 1/4", 1 1/2", 1 3/16", 1 3/4"	1 1/8" x 2 3/4" square corner
10-004	1 1/8"	1 1/8" x 2 3/4" radius round corner
10-025	1 3/16", 1 3/8"	1 1/4" x 2 7/8" ANSI
C603-623	-	Box for T-strike
K510-066	-	Box for 10-025

Rabbeted latch and strike kit

39-030

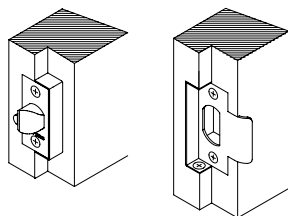

Wood frame reinforcer

37-016

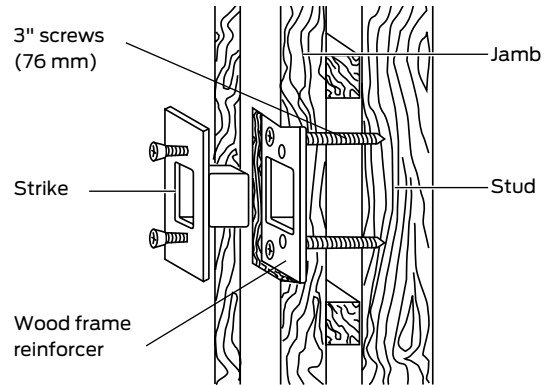

Furnished with standard and round corner deadbolt strikes, this reinforcer significantly strengthens a jamb against “kick-in” attack and greatly increases the security of the lock. The reinforcer is concealed under the strike and is anchored to the jamb with two 3" long screws.

B500 Series metal dust box reinforcer anchors (B520-622) to jamb with three 3" screws.

Thumbturn assemblies and inside plates

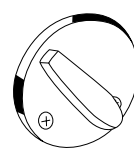

B302-041
B560, B580, B581
B302-045
B563

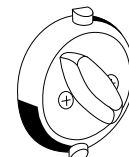

B202-672
B250 with holdback (standard)

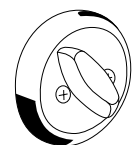

B202-671
B250 without holdback



12-617
B660/760/860
12-618
B663/763/863

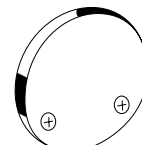

12-626
B661/761/861

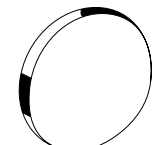

38-034
Blank mounting plate kit for B580

Accessories and other parts

Adapters for B250 and B500 Series in 2 1/8" prep (specify finish)

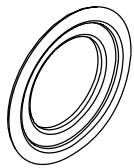

38-031
For cylinder

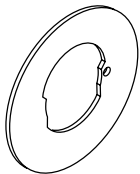

38-032
For B250
thumbturn



38-018
Thin door spacer fits
under 38-031 adapter
for B250 Series.

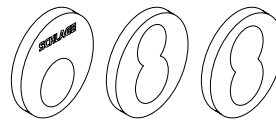

**Inside cylinder faceplates for B562
and B662/762/862**
(specify finish)

38-016 kit for B252 contains two 38-031 adapters

38-017 kit for B250 contains one 38-031 and one 38-032 adapter

Tailpieces

B250 Series tailpieces

(non-IC models)

Function	Pins	Door range	Tailpiece
B250	5 or 6	1 ³ / ₈ " - 2 ³ / ₄ " (35 mm-70 mm)	B202-558
B252	5 or 6	1 ³ / ₈ " - 1 ³ / ₄ " (35 mm-44 mm)	B202-370
	6	2", 2 ³ / ₄ " (51 mm, 70 mm)	
	6	2 ¹ / ₄ ", 2 ¹ / ₂ " (58 mm, 64 mm)	B202-269
	5	2 ¹ / ₂ " (64mm)	B202-453

Two each required for double cylinder locks.

B500 Series tailpieces

(non-IC models)

Function	Description	Tailpiece
B560, B563	1 ³ / ₈ " - 1 ³ / ₄ " (35 mm-44 mm)	B520-651
	1 ³ / ₄ " - 2 ¹ / ₄ " (44 mm-58 mm)	B520-652
B571	1 ³ / ₈ " - 2 ¹ / ₄ " (35 mm-58 mm)	B520-653
B580, B581	1 ³ / ₈ " - 2 ¹ / ₄ " (35 mm-58 mm)	B600-041
B562	1 ³ / ₈ " - 1 ³ / ₄ " (35 mm-44 mm)	B600-045
	1 ³ / ₄ " - 2 ¹ / ₄ " (44 mm-58 mm)	B600-046

Two each required for double cylinder locks.

See price book for additional tailpieces.

B Series interchangeable core tailpieces

Function	Tailpiece
B560BD, B563BD	B202-957
B560J, B660J, B661J, B663J	B600-041
B562BD (two tailpieces required)	B202-580
B562J, B662J (two tailpieces required)	B600-040
B660BD, B663BD	B202-557
B561BD	B220-032
B662BD (two tailpieces required)	B202-370
B662BD thick door (two tailpieces required)	B202-453

B600R and B700R Series use the same tailpieces as listed for B600J Series.

B600/700/800 Series tailpiece and retainer packs

(non-IC)

Function	Door range	Classic conventional	All others
B660/760/860, B663/763/863	1 ³ / ₈ " - 2 ¹ / ₂ " (35 mm-64 mm)	B610-044	B610-084
B662/762/862 (dbl. cylinder)	1 ³ / ₈ " - 2" (35 mm-51 mm)	B610-045	B610-085
	>2" - 2 ¹ / ₂ " (>51 mm-64 mm)	B610-046	B610-086
B661/761/861, B664/764/864	1 ³ / ₈ " - 2" (35 mm-51 mm)	B610-042	B610-082
	>2" - 2 ¹ / ₂ " (>51 mm-64 mm)	B610-043	B610-083

Two each required for double cylinder locks.

Specifications

Handing:

B250 Series deadlatches are reversible. All other B Series locksets are non-handed.

Door thickness:

B500 Series, 5-pin: 1³/₈" to 1³/₄" (35 mm to 44 mm) standard. Available to 2¹/₄" (57 mm), assembled to order.

B250 Series, 5-pin: 1³/₈" to 1³/₄" (35 mm to 44 mm) standard. Available to 2¹/₄" (57 mm), assembled to order.

B600/700/800 Series: 1³/₄" to 2" (44 mm to 51 mm) standard. Available for 1³/₈" (35 mm) and doors up to 2¹/₂" (63mm), assembled to order. Door ranges may vary by function.

Backset:

B500 Series: Adjustable for 2³/₈" (60 mm) or 2³/₄" (70 mm) standard.

B250 Series: 2³/₈" (60 mm) standard. 2³/₄" (70 mm) optional.

B600/700/800 Series: 2³/₄" (70 mm) standard, 2³/₈" (60 mm), 3³/₄" (95 mm), 5" (127 mm) optional.

Front:

Brass, bronze or stainless steel. 1¹/₈" x 2¹/₄" (29 mm x 57 mm) square corner, beveled.

Dead bolt:

1" (25 mm) throw with saw-resistant hardened steel insert.

Latch bolt:

Brass, ⁹/₁₆" (14 mm) throw, deadlocking on keyed and exterior functions.

Exposed trim:

Wrought or forged brass or bronze, or pressure cast zinc.

Thumbturn:

Pressure cast zinc, plated to match finish symbols.

Strike:

B250 and B600/700/800 Series: 1¹/₈" x 2³/₄" (32 mm x 70 mm) with steel reinforcer and two 3" screws standard. B500 Series: 1¹/₈" x 2³/₄", metal dust box reinforcer and three 3" screws. Optional strikes, lip lengths and ANSI strike box available. See page 27.

Cylinder and keys:

6-pin patented Everest 29 S123 keyway standard with two nickel silver keys per lock. Items specified in C keyway will be furnished 5-pin.

Keying options:

Interchangeable core and Primus XP high security cylinders. Master keying, grand master keying and construction keying.

Warranty:

Commercial: Three-year limited.

Certifications

ANSI:

B500 and B250 Series meet or exceed A156.5 Grade 2 strength and operational requirements. B600/700/800 Series meets or exceeds A156.5 Grade 1 strength and operational requirements.

UL / cUL:

B600/700/800-Series locks are UL10B Listed auxiliary locks for A label single doors, 4' x 8'. UL10B Listing optional for B500-Series as auxiliary locks. Letter F and UL symbol on latch front indicate listing.

UL437 Listed locking cylinder optional:

Specify Primus 20-500 Series cylinder for B500 and B250 Series Grade 2 products, or specify B800 Series Grade 1 products.

ADA compliant:

Schlage Lock Company offers a wide selection of locks designed to meet the Americans with Disabilities Act.

About Allegion

Allegion (NYSE: ALLE) creates peace of mind by pioneering safety and security. As a \$2 billion provider of security solutions for homes and businesses, Allegion employs more than 8,000 people and sells products in more than 120 countries across the world. Allegion comprises 27 global brands, including strategic brands CISA®, Interflex®, LCN®, Schlage® and Von Duprin®.

For more, visit www.allegion.com

aptiQ ■ LCN ■ **SCHLAGE** ■ STEELCRAFT ■ VON DUPRIN